



City of Killeen

Agenda

City Council Workshop

Tuesday, December 4, 2018

5:00 PM

Utility Collections
Conference Room
210 West Avenue C
Killeen, Texas 76541

Citizens Petitions and Information

1. [CP-18-008](#) Carla White - Property Flooding Issues

Items for Discussion at Workshop

2. [DS-18-099](#) Discuss Agenda Items for the Regular City Council Meeting of December 11, 2018

3. [DS-18-100](#) Sanitary Sewer Service Lateral Maintenance Briefing

Attachments: [Presentation](#)

4. [DS-18-101](#) Discuss Economic Development Policies

Attachments: [Presentation](#)

5. [DS-18-102](#) Discuss Election Day Polling Locations

Attachments: [Staff Report](#)
[Presentation](#)

6. [DS-18-103](#) Discuss Heritage Oaks Hike & Bike Trail, Segment 5 Grant Funding

Attachments: [Presentation](#)

7. [DS-18-104](#) City Manager Updates
· Discuss Fees Associated with Downtown Development

8. [DS-18-105](#) Receive Legal Advice Regarding the Award of a Construction Contract for the South Water Supply Project

Councilmember Requests for Future Agenda Items

9. [RQ-18-012](#) Future Agenda Item Requests:
· Status Update of Governing Standards and Expectations Requirement for Ethics Policy, Standards of Conduct, and Disclosure Statement

Items for Regular City Council Meeting of December 11, 2018

Minutes

10. [MN-18-028](#) Consider Minutes of Regular City Council Meeting of November 27, 2018.

Attachments: [Minutes](#)

Resolutions

11. [RS-18-106](#) Consider a memorandum/resolution to approve the Killeen Fort Hood Regional Airport rental car agreements.

Attachments: [Staff Report](#)

[Avis Agreement](#)

[Alamo Agreement](#)

[Clearwater Agreement](#)

[Enterprise Agreement](#)

[Hertz Agreement](#)

[Certificate of Interested Parties](#)

[Presentation](#)

12. [RS-18-107](#) Consider a memorandum/resolution adopting the 2019 State Legislative Priorities and Principles.

Attachments: [Staff Report](#)

[State Legislative Priorities and Principles 2019](#)

[Presentation](#)

13. [RS-18-108](#) Consider a memorandum/resolution awarding Bid No. 19-04 for a Water and Sewer supply items purchase agreement with ACT Pipe and Supply, Ferguson Waterworks, and Zenner USA.

Attachments: [Staff Report](#)

[Bid Tab Sheet](#)

[Certificate of Interested Parties](#)

[Presentation](#)

Ordinance

14. [OR-18-017](#) Consider an ordinance amending Chapter 25, Streets, Sidewalks, and Miscellaneous Public Places by establishing a Street Maintenance Fund and providing for collection of street maintenance fees.

Attachments: [Staff Report](#)

[Ordinance](#)

[Presentation](#)

Public Hearings

15. [PH-18-037](#) HOLD a public hearing and consider an ordinance by Reece's Creek Group, L.C. (Case #Z18-23) to rezone Lots 3A-8A, Block 3, University Village, Second Amendment and Lots 10-13, Block 3, University Village, from University District ("UD") with a Conditional Use Permit (C.U.P.) for "RT-1" (Residential Townhouse Single-Family District) to University District ("UD") with a Conditional Use Permit (C.U.P.) for "R-2" (Two-Family Residential District). The properties are addressed as 6700, 6702, 6704, 6706, 6708 and 6710 Student Union Drive and 6701, 6703, 6705 and 6707 University Village Way, Killeen, Texas.

Attachments: [Staff Report](#)

[Zoning Map and Notification Area](#)

[Minutes](#)

[Ordinance](#)

[Pharr vs Tippitt](#)

[Amending Plat Exhibit](#)

[Presentation](#)

Adjournment

I certify that the above notice of meeting was posted on the Internet and on the bulletin boards at Killeen City Hall and at the Killeen Police Department on or before 5:00 p.m. on November 30, 2018.

Lucy C. Aldrich, City Secretary

The public is hereby informed that notices for City of Killeen meetings will no longer distinguish between matters to be discussed in open or closed session of a meeting. This practice is in accordance with rulings by the Texas Attorney General that, under the Texas Open Meetings Act, the City Council may convene a closed session to discuss any matter listed on the agenda, without prior or further notice, if the matter is one that the Open Meetings Act allows to be discussed in a closed session..

This meeting is being conducted in accordance with the Texas Open Meetings Law [V.T.C.A., Government Code, § 551.001 et seq.]. This meeting is being conducted in accordance with the Americans with Disabilities Act [42 USC 12101 (1991)]. The facility is wheelchair accessible and handicap parking is available. Requests for sign interpretive services are available upon requests received at least 48 hours prior to the meeting. To make arrangements for those services, please call 254-501-7700, City Manager's Office, or TDD 1-800-734-2989.

Notice of Meetings

The Mayor and/or City Council have been invited to attend and/or participate in the following meetings/conferences/events. Although a quorum of the members of the City Council may or may not be available to attend this meeting, this notice is being posted to meet the requirements of the Texas Open Meetings Act and subsequent opinions of the Texas Attorney General's Office. No official action will be taken by Council.

- *Bell County Farewell Reception, December 4, 2018, 5:00 p.m., Bell County Expo Center*
- *56th Annual Christmas Parade, December 8, 2018, 4:30 p.m., Downtown Killeen*

Dedicated Service -- Every Day, for Everyone!



City of Killeen

Legislation Details

File #: CP-18-008 **Version:** 1 **Name:** Carla White - Property Flooding Issues
Type: Citizen Petition **Status:** Citizens Petitions
File created: 11/21/2018 **In control:** City Council Workshop
On agenda: 12/4/2018 **Final action:**
Title: Carla White - Property Flooding Issues
Sponsors: City Manager Department
Indexes:
Code sections:
Attachments:

Date	Ver.	Action By	Action	Result
------	------	-----------	--------	--------



City of Killeen

Legislation Details

File #: DS-18-099 **Version:** 1 **Name:** Discuss Agenda Items
Type: Discussion Items **Status:** Discussion Items
File created: 11/16/2018 **In control:** City Council Workshop
On agenda: 12/4/2018 **Final action:**
Title: Discuss Agenda Items for the Regular City Council Meeting of December 11, 2018
Sponsors: City Manager Department
Indexes:
Code sections:
Attachments:

Date	Ver.	Action By	Action	Result
------	------	-----------	--------	--------



City of Killeen

Legislation Details

File #: DS-18-100 **Version:** 1 **Name:** Sanitary Sewer Service Lateral Maintenance Briefing
Type: Discussion Items **Status:** Discussion Items
File created: 11/8/2018 **In control:** City Council Workshop
On agenda: 12/4/2018 **Final action:**
Title: Sanitary Sewer Service Lateral Maintenance Briefing
Sponsors: City Manager Department
Indexes:
Code sections:
Attachments: [Presentation](#)

Date	Ver.	Action By	Action	Result
------	------	-----------	--------	--------

Service Line Warranty Program

NATIONAL
LEAGUE
of CITIES



Building Peace of Mind, One Community at a Time

NLC Mission and Core Principles



- The National League of Cities is dedicated to **helping city leaders build better communities.**
- **Cities Lead:** When the nation's cities and towns are stronger, all of America is stronger.
- **NLC stands for local control** and an effective federal-city partnership.
- **NLC is a member-driven organization** and strives to be unified, inclusive, focused, valuable, influential, visible, relationship driven, forward leaning, and financially solid.

Reasons for Participation

- NLC Program / Over 500 Cities Participating in U.S. and Canada
- NLC Awareness Campaign
- Innovative Option Appreciated by Homeowners / Exclusive Access for Homeowners
- Program has spent over \$350 million on homeowner repairs in past 3 years
- Line replacements can cost homeowner thousands of dollars
- A+ Accredited BBB Rating
- Turnkey Solution for City

Several Participating Cities



Endorsed by the *National League of Cities, North Central Texas Council of Governments, Multiple State Municipal Leagues, and 200 Municipalities, including:*

San Diego, CA

Phoenix, AZ

Mesa, AZ

Tucson, TX

Las Vegas, NV

Arlington, TX

Tulsa, OK

York, PA

Harrisburg, PA

Atlanta, GA

Dayton, OH

Odessa, TX

Kansas City, MO

North Las Vegas, NV

Fort Lauderdale, FL

Madison, WI

Englewood, CO

North Chicago, IL

Lawton, OK

Stillwater, OK

Santa Fe, NM

Problem

- Average age of a home in the U.S. is 37 years old (US Census Bureau)
- Only 18% of Americans could afford a \$4,000 unplanned expense (US Census Bureau)
- I&I problems, lack of water conservation, environmental hazards
- Lateral service lines, because they are subsurface, are often overlooked by homeowner (until a problems arise)
- Cities cannot help when a homeowner has a problem and calls city hall for a solution

Solution: NLC Service Line Warranty Program

- Create Public Awareness
- Offer homeowner an affordable option that solves this problem
- No cost for city
- No liability for the city
- Voluntary and optional
- No Red-lining (program allows any homeowner in city to participate)
- City-based contractors used
- Homeowner saves money
- City saves money
- Month to month contracts for homeowner
- 24/7/365 customer service
- All repairs performed to local code

Provides protection from the point of entry at the home (including slab) to the utility responsibility

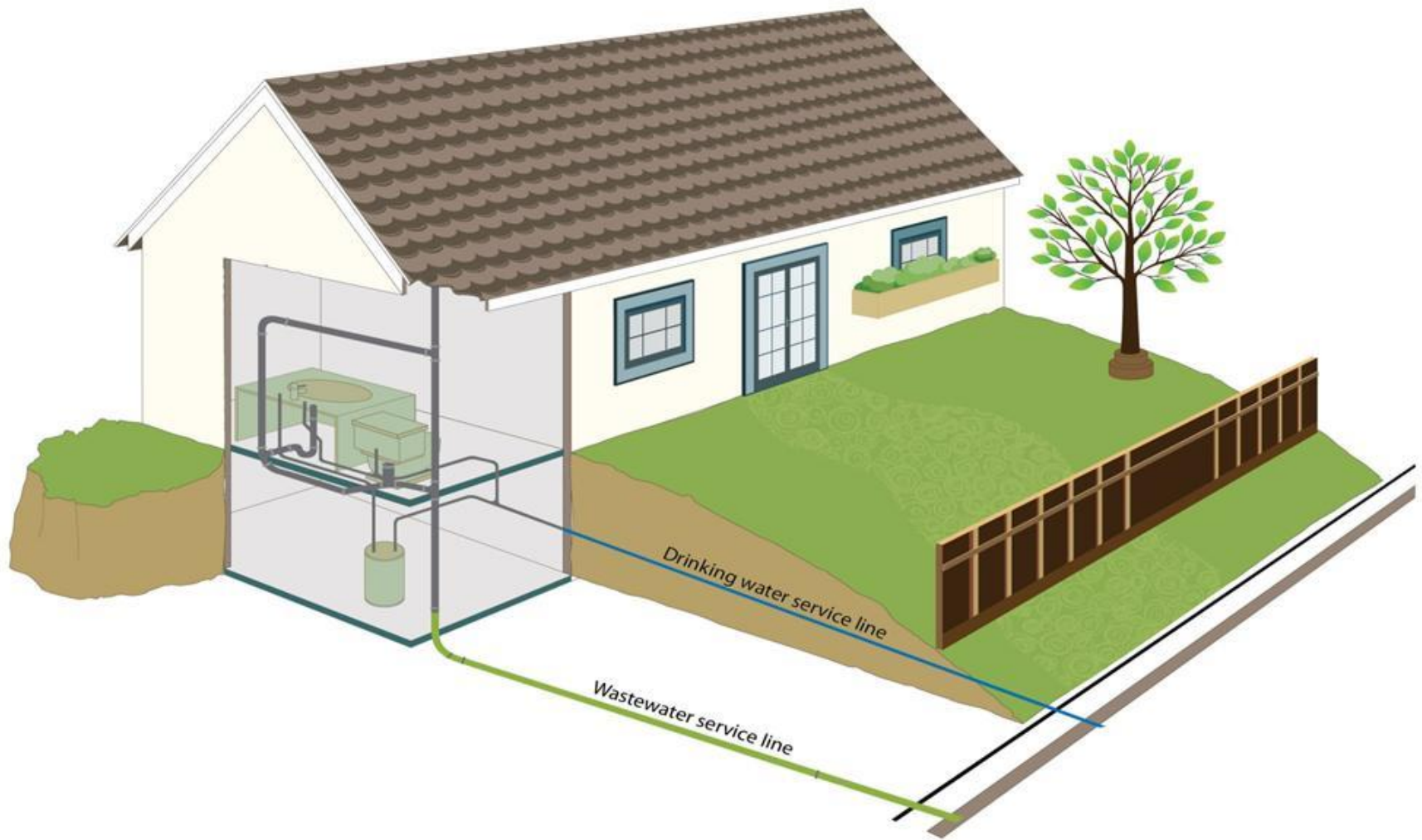

External Water & Sewer Line Product Overview

Product	Coverage Description	Coverage Limits per Occurrence
External Water Line Warranty	Covers the repair or replacement of a leaking or broken single underground water supply line serving the home. The warranty covers the consumer owned portion of the water supply line.	\$4,000 plus \$500 for public sidewalk repair

Product	Coverage Description	Coverage Limits per Occurrence
External Sewer Line Warranty	Covers the repair or replacement of a broken underground sewer line from the utility's main sewer line to the internal point of entry to the home.	\$4,000 plus \$4,000 for public street repair

- No long term contracts, no lifetime or annual caps
- \$8,000 for Sewer Line Protection and \$4,000 for Water Line Protection (per callout)
- Optional and voluntary
- Service fees and permit fees are covered
- No Pre-existing Conditions and IMMEDIATE COVERAGE

Customer Advocacy Results

BBB ACCREDITED BUSINESS SINCE 12/14/2006

Service Line Warranties of America

Fax: (724) 749-4520

[View Additional Phone Numbers](#)

11 Grandview Cir Ste 100, Canonsburg, PA 15317

partnerships@utilitysp.net

<http://www.slwofa.com>

[View Additional Web Addresses](#)



On a scale of A+ to F

[Reason for Rating](#)
[BBB Ratings System](#)
[Overview](#)

Customer Complaints Summary

4 complaints closed with BBB in last 3 years | 4 closed in last 12 months

Complaint Type	Total Closed Complaints
Advertising/Sales Issues	0
Billing/Collection Issues	1
Delivery Issues	0
Guarantee/Warranty Issues	2
Problems with Product/Service	1
Total Closed Complaints	4

Implementation is Easy

- Obtain Council Approval

- Execute the Marketing Services Agreement
 - Provides for the use of City logo on marketing materials
 - Indemnifies the City

- Review and Approve Welcome Kit Materials
 - Press Release
 - Web Banner
 - Marketing Letter

Real-Time Partner Portal Reporting



Partner Reports

PARTNER REPORTS

PARTNER REPORT TRAINING

CREATE NEW USER ID

WELCOME KIT MATERIALS

MATERIALS APPROVAL

CUSTOMER SURVEYS

CONTRACTOR NETWORK

LOGOUT

[Web Training Video](#) [Partner Reporting Manual](#)

Coming soon!

Please select which report you would like to view by clicking the drop down arrow below.

Partner Summary

Begin Date (mm-dd-yyyy) End Date (mm-dd-yyyy)

1 of 1

Select a format Export

Partner Summary

PARTNER NAME	PRODUCT DESCRIPTION	BEGIN DATE	END DATE	ENROLLMENTS	CLAIMS FILED
Demo Partner	External Sewer Line Warranty	Jan 01, 2011	Jan 01, 2013	247	27
	External Water Line Warranty	Jan 01, 2011	Jan 01, 2013	93	12
Total For 1/1/2011 To 1/1/2013				340	39
TOTAL (To Current Day)				943	77

"Service Line Warranties of America assimilates integrity, ethics, trust, and honesty as central values for its organization. This firm's ethical employee training includes six pillars of character and emphasizes a positive approach toward 'the benefits of being ethical.' The firm also created a Community and Employee Engagement Committee to better enable the firm to act responsibly toward the community."

Dr. James Weber
BBB Torch Award Judge
Professor of Business Ethics and Management
Duquesne University



Building Peace of Mind, One Community at a Time

“Considering the large customer base that Service Line Warranties of America has worked with over these past 10 years and their exemplary record at the Bureau, I'm proud to have you as an accredited business of the BBB. There were several key things that stood out in your business philosophy – full disclosure and communication with customers, partners, vendors and staff, which are part of the company's daily ethical standards and values; honoring promises by providing service in the fairest and most honest way possible; and acting with integrity which involves mutual respect.”

Warren King
President
Better Business Bureau, Western PA



Building Peace of Mind, One Community at a Time

“This award underscores one of the primary reasons the National League of Cities selected USP as a partner and extended our agreement for another five years. The organization's exemplary record of customer service and transparency is what has driven the success of this partnership over the years.”

Clarence Anthony
Executive Director
National League of Cities



Building Peace of Mind, One Community at a Time

“The program has already paid out over \$1 million in repairs and replacements for our homeowner’s lateral service lines. My constituents are happy that we have provided this option for city homeowners. We use the revenue associated with the program to assist lower income homeowners with repairs to their service lines. I am sure your City will be pleased with the NLC Service Line Program.”

Felicia Moore
Councilmember, City of Atlanta, GA



Building Peace of Mind, One Community at a Time

Dear Felecia, On Christmas Day my sewer line backed up into my house and into my tub! I could not flush toilets or take a shower or wash dishes or clothes or even my hands. It turned out to be due to a clogged sewer line in my front yard. Thanks to you, I had the warranty and did not have to pay for the \$2000 plus repair! Thank you! The warranty company had good customer service and the local plumbing company that they sent to do the work, Atlanta Plumbing Plus, WAS AMAZING! They did a wonderful job and were very respectful of my property (and my anxiety about the situation). Thank you so much Felicia for always looking out for us!

Cindy
Homeowner, Atlanta, GA



Building Peace of Mind, One Community at a Time

"The Service Line Protection Program helps Phoenix residents and the city government. Revenue from the program goes to core city services like police, fire, parks, libraries and senior centers, and the warranties give residents an option for repairs to their sewer and water lines."

John Brodsky
Public Information Officer
City of Phoenix, AZ



Building Peace of Mind, One Community at a Time

“We have now passed the 10,000 enrollment mark. Strength in participation brings benefits to our entire community. Our residents are able to avoid the high costs of unexpected repairs, our economy benefits since local contractors perform the repair work, and our city benefits from the new source of revenue.”

Joe Davis
Alderman
City of Milwaukee, WI

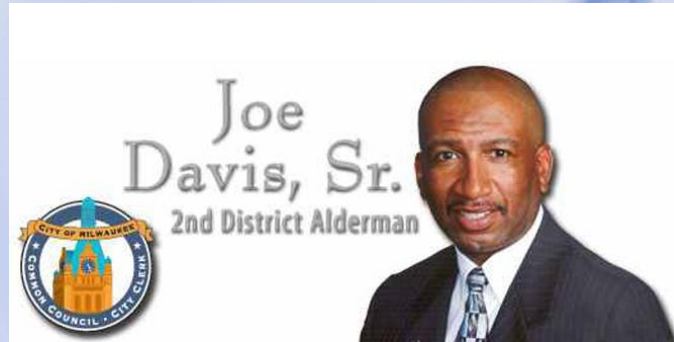

Building Peace of Mind, One Community at a Time

“The city has fully vetted this program and conducted proper due diligence. The program is endorsed by the National League of Cities, North Central Texas Council of Governments, multiple state municipal leagues and over 200 cities nationwide. They also have an exemplary BBB record dating back to 2003.”

Todd Gloria
City Council
City of San Diego, CA



Building Peace of Mind, One Community at a Time

“The program payouts have been huge for our homeowners (over \$230,000 in water and sewer line repairs in 24 months). It really illustrates the fact that the program is responsive and very much needed.

Please feel free to send potential participating cities to me for an outstanding reference.”

Bryan Long
City Manager
City of Lawton, OK



Building Peace of Mind, One Community at a Time



City of Killeen

Legislation Details

File #: DS-18-101 **Version:** 1 **Name:** Discuss Economic Development Policies
Type: Discussion Items **Status:** Discussion Items
File created: 11/19/2018 **In control:** City Council Workshop
On agenda: 12/4/2018 **Final action:**
Title: Discuss Economic Development Policies
Sponsors: City Manager Department
Indexes:
Code sections:
Attachments: [Presentation](#)

Date	Ver.	Action By	Action	Result
------	------	-----------	--------	--------



ECONOMIC DEVELOPMENT POLICIES PRESENTATION

DS-18-101

December 4, 2018

Division 1: Introduction

- The City desires to stimulate economic development activity by attracting investments to create competitive wage jobs and broaden the tax base.
- The Killeen Economic Development Corporation (KEDC), is the economic development arm of the City.

Division 2: Economic Development Program

3

□ Purpose

The purpose of these policies is to attract new businesses and encourage expansion of existing businesses. The City of Killeen, through KEDC, may offer assistance to retain existing businesses when appropriate.

The City desires to support applicants or projects that support:

- Growth of private sector employment that provides competitive wage jobs and talent development,
- Increased tax revenue and other revenues,
- Diversifying the economic base, and/or
- Public infrastructure development.

Division 2: Economic Development Program (cont'd)

4

□ Goals:

- Stimulate creation/retention of competitive wage jobs
- Encourage private capital investment that generates revenue to support the City's services and infrastructure
- Economic Diversification
- Workforce Development
- Business Retention & Expansion
- Target specific geographic areas for Investment
- Public Infrastructure Development
- Place design to shape developments

Division 3: Components of Economic Development

5

- Workforce Development- Coordinate with the Workforce Solutions of Central Texas to provide employment assistance and training
- Provision of Infrastructure- The City/KEDC shall consider paying or reimbursing businesses/developers for all or a portion of the cost of public infrastructure required for targeted economic development to occur.

Division 3: Components of Economic Development (cont'd)

6

- Availability of utilities – Local utility providers want to accommodate new development and work with business developers to provide needed utilities.
- Access to capital - The City, through KEDC, shall assist businesses by connecting them with available funding alternatives to obtain loans, grants, or other resources.
- Compatible government regulations- The City shall streamline the economic development process so that it is efficient and not unnecessarily burdensome, while remaining in compliance with all applicable state, federal and local laws.

Division 3: Components of Economic Development (cont'd)

7

- **Economic Development Partners**
 - ▣ **City Council** - It is the role of the City Council to consider and adopt economic development incentive policies to attract businesses and industry to promote the creation and retention of competitive jobs. The City Council shall annually audit agreements and the adopted policies.
 - ▣ **City of Killeen Staff** - City staff's role is to implement the policies.
 - ▣ **Killeen Economic Development Corporation (KEDC)** - KEDC is responsible for economic development. It recommends to the City Council projects and programs to further economic development. They report their activities to the City Council.

Division 3: Components of Economic Development (cont'd)

- KEDC is authorized to commit and spend allocated funds contributing to the creation of new jobs or retention of jobs without securing prior approval from the City Council for all activities authorized in their agreement with the City.
- KEDC shall obtain City Council consent prior to entering into any agreement requiring expenditure of public funds or for any agreement expending allocated funds in a manner not specifically authorized. For purposes of this document, “public funds” are City budgeted funds that do not include funds that have been allocated to KEDC pursuant to an agreement with KEDC for economic development services.

Division 3: Components of Economic Development (cont'd)

- When incentives that require City Council action are contemplated, KEDC shall make recommendations to the City Council prior to making commitments.
- KEDC shall report quarterly to the City Council on the amount and nature of expenditures or commitments made of funds received from the City. If the need arises for additional communication on a sensitive matter, KEDC shall communicate to City Council members within the bounds of the law.

Division 3: Components of Economic Development (cont'd)

10

- **The Greater Killeen Chamber of Commerce (GKCC)**
 - The GKCC focuses on programs that will lead to the creation of jobs with competitive wages in the service, manufacturing and retail sectors.
- **Other partners** are the Killeen Industrial Foundation, Workforce Solutions of Central Texas, Business Resource Center, Texas A&M Central Texas (TAMU-CT), and Central Texas College (CTC).

Division 4: Economic Development Process

11

- The development process includes identifying appropriate sites, identifying available services, providing appropriate incentives, and finding companies that will locate in Killeen and guiding them in the development process.

Division 5: Economic Development

Incentives Toolbox

12

- The City has many incentives in its tool box, including:
 - ▣ tax abatement,
 - ▣ fee waivers,
 - ▣ grants,
 - ▣ 380 development agreements,
 - ▣ Federal and State incentives, etc.

Division 6: Targeted Businesses and Industries

13

- The City of Killeen wants to attract clean industrial development, defense related businesses, business retention, regional health and medical services, technology and cyber-security, alternative energy, etc.
- Economic development efforts are to target new and expanding businesses that offer competitive wage jobs and/or make capital investment.
- The City desires to encourage the development of regional retail opportunities.
- The City desires to retain existing businesses/industries at the discretion of the City Council.

DIVISION 7:ANNUAL REVIEW OF POLICIES

14

- To ensure the ongoing relevance of the Economic Development Policies the City Council shall evaluate them annually after receiving an annual report.



City of Killeen

Legislation Details

File #: DS-18-102 **Version:** 1 **Name:** Discuss 2019 Election Polling Locations
Type: Discussion Items **Status:** Discussion Items
File created: 11/16/2018 **In control:** City Council Workshop
On agenda: 12/4/2018 **Final action:**
Title: Discuss Election Day Polling Locations
Sponsors: City Attorney Department, City Secretary
Indexes:
Code sections:
Attachments: [Staff Report](#)
[Presentation](#)

Date	Ver.	Action By	Action	Result
------	------	-----------	--------	--------



STAFF REPORT

DATE: December 4, 2018
TO: Ronald L. Olson, City Manager
FROM: Kathy Davis, City Attorney
SUBJECT: Discuss Election Day Polling Locations

BACKGROUND AND FINDINGS:

After analyzing election data for the City of Killeen over the past three years, staff has identified several polling locations that are historically underused on Election Day. Additionally, each year staff encounters difficulty identifying willing and capable election-day workers. Because of this, city staff is requesting that the City Council consider the feasibility of reducing election-day polling locations.

THE ALTERNATIVES CONSIDERED:

1. Discuss and consider the reduction in election-day polling locations.
2. Do not discuss or consider the reduction in election-day polling locations.

Which alternative is recommended? Why?

It is recommended that the City Council discuss and consider whether to reduce the number of election-day polling locations.

CONFORMITY TO CITY POLICY:

State election law gives the City Council the authority and responsibility to establish polling locations for municipal elections.

FINANCIAL IMPACT:

What is the amount of the expenditure in the current fiscal year? For future years?

This discussion will not affect expenditures. However, reducing polling locations would result in a reduction in election expenses of approximately \$4,000 per location.

Is this a one-time or recurring expenditure?

N/A

Is this expenditure budgeted?

N/A

If not, where will the money come from?

N/A

Is there a sufficient amount in the budgeted line-item for this expenditure?

N/A

RECOMMENDATION:

Staff recommends that the Council discuss and consider whether to reduce the number of election-day polling locations.

DEPARTMENTAL CLEARANCES:

N/A

ATTACHED SUPPORTING DOCUMENTS:

N/A



POLLING LOCATIONS

DS-18-102

December 4, 2018

Historical Information

2

- 4 Early Voting polling locations
- 13 Election Day polling locations
- Employ approximately 60-65 election workers

Election Day Voter Numbers

DISTRICT 1				
Precinct		2016	2017	2018
106	1 - FS#1: Westcliff Road	115	78	115
109	2 - St. Josephs: Rancier	69	49	74
201/204	3 - FS#3: Twin Creek Drive	41	33	73
410	4 - Fire Support: Ave. D	43	18	35
		<u>268</u>	<u>178</u>	<u>297</u>
DISTRICT 2				
Precinct				
205	5 - Jackson Prof.: Rev RA Americrombie	93	80	99
203/208/210	6 - Cedar Valley Elementary: Chantz Dr.	222	214	314
207	7 - Copper Mtn Library: WS Young Dr.	49	62	80
		<u>364</u>	<u>356</u>	<u>493</u>
DISTRICT 3				
Precinct				
206/402/409	8 - LCP Senior Ctr: Stan Schlueter Loop	121	62	110
406	9 - Central FS: 28th St.	74	66	97
404	10 - FS#7: Watercrest	111	67	235
408	11 - FS#5: Jasper Dr.	126	84	161
		<u>432</u>	<u>279</u>	<u>603</u>
DISTRICT 4				
Precinct				
401/412/413	12 - FS#9: Bunny Trail	121	69	220
405	13 - Shoemaker: Clear Creek Rd.	66	50	98
		<u>187</u>	<u>119</u>	<u>318</u>
TOTAL VOTERS		<u><u>1,251</u></u>	<u><u>932</u></u>	<u><u>1,711</u></u>

Current Polling Locations

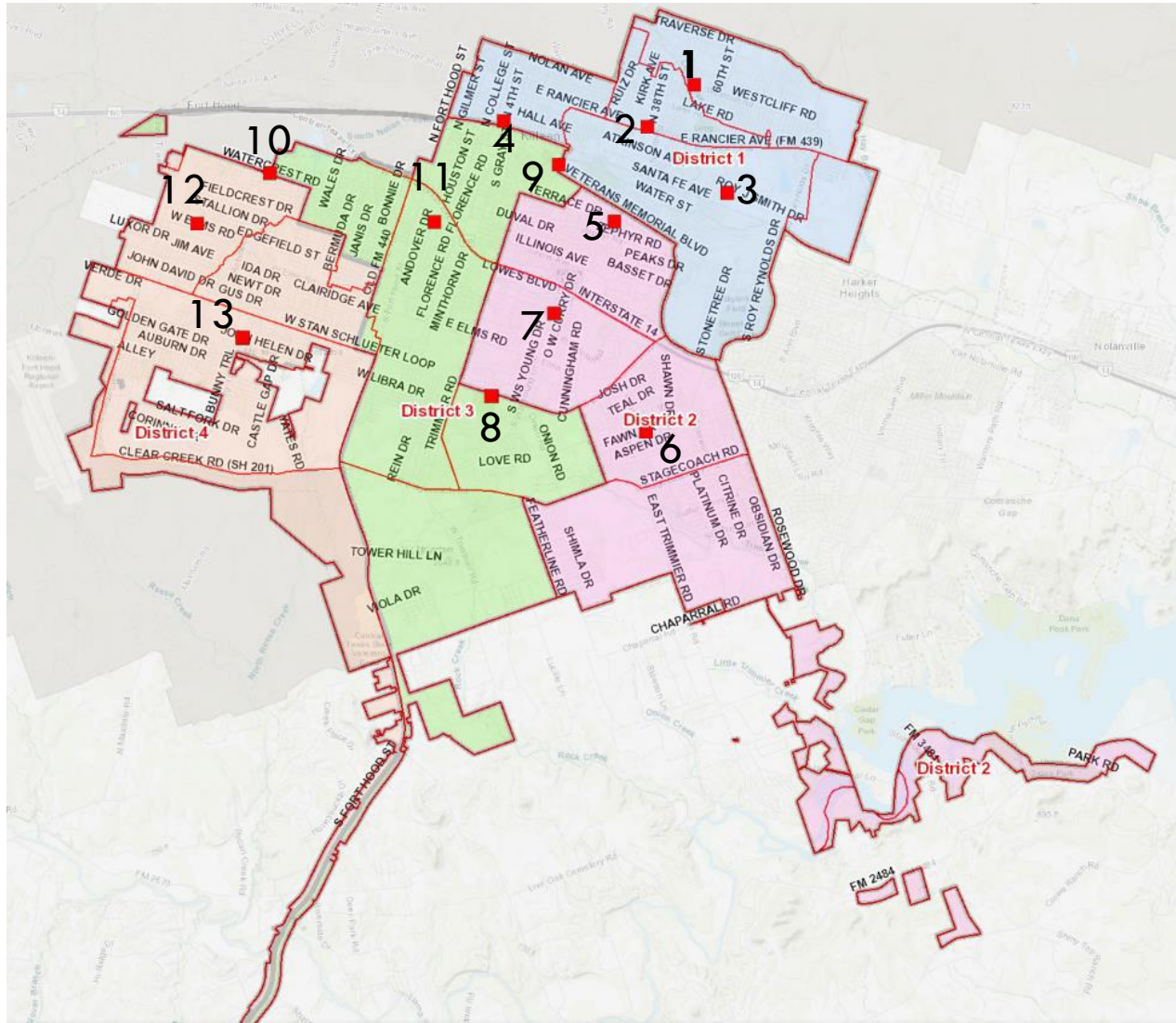

Election Day Voter Numbers

5

DISTRICT 1

Precinct		2016	2017	2018
106	1 - FS#1: Westcliff Road	115	78	115
109	2 - St. Josephs: Rancier	69	49	74
201/204	3 - FS#3: Twin Creek Drive	41	33	73
410	4 - Fire Support: Ave. D	43	18	35
		268	178	297

DISTRICT 2

Precinct		2016	2017	2018
205	5 - Jackson Prof.: Rev RA Americrombie	93	80	99
203/208/210	6 - Cedar Valley Elementary: Chantz Dr.	222	214	314
207	7 - Copper Mtn Library: WS Young Dr.	49	62	80
		364	356	493

DISTRICT 3

Precinct		2016	2017	2018
206/402/409	8 - LCP Senior Ctr: Stan Schlueter Loop	121	62	110
406	9 - Central FS: 28th St.	74	66	97
404	10 - FS#7: Watercrest	111	67	235
408	11 - FS#5: Jasper Dr.	126	84	161
		432	279	603

DISTRICT 4

Precinct		2016	2017	2018
401/412/413	12 - FS#9: Bunny Trail	121	69	220
405	13 - Shoemaker: Clear Creek Rd.	66	50	98
		187	119	318

TOTAL VOTERS **1,251** **932** **1,711**

Proposed Polling Locations

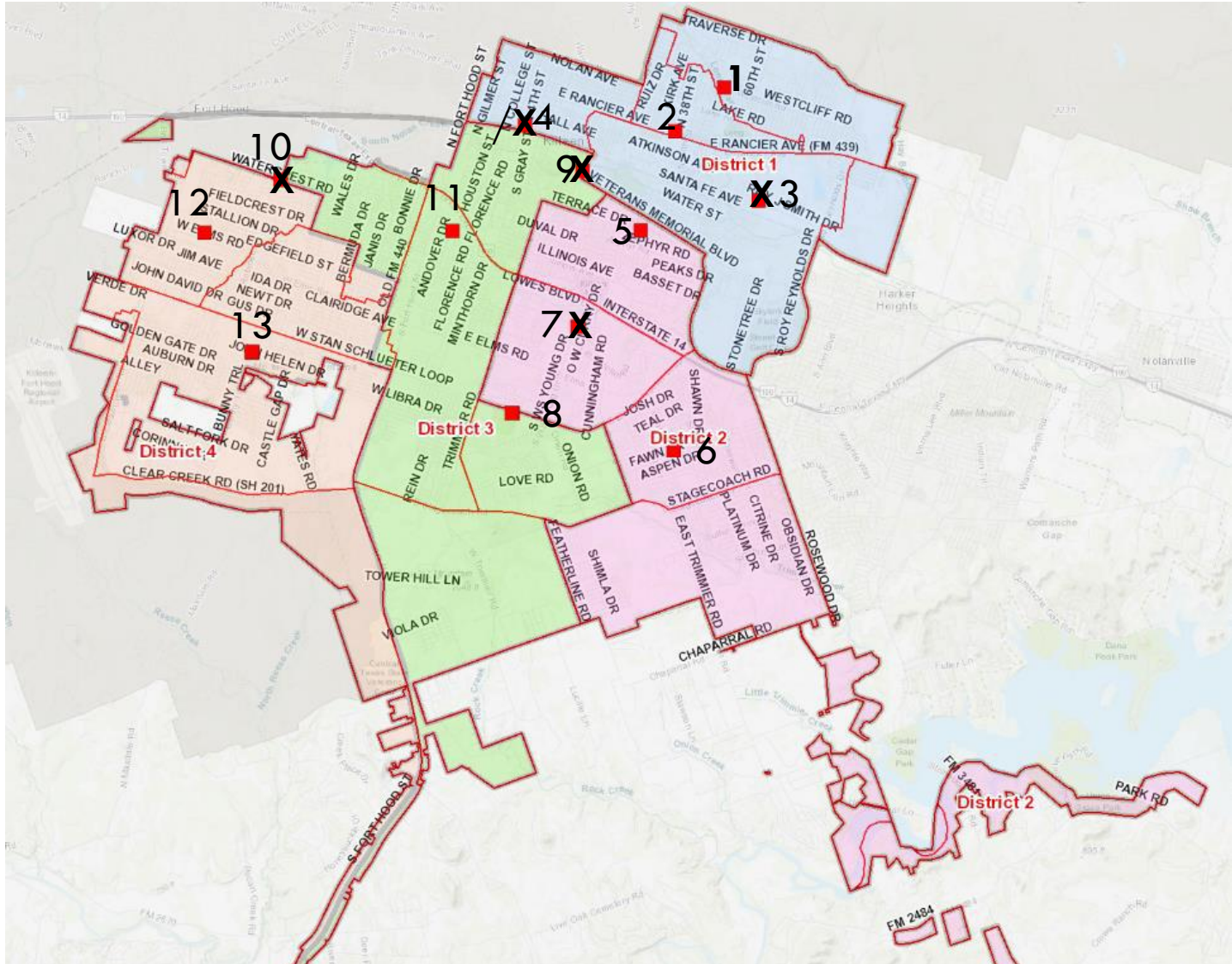

Approximate Cost Per Polling Location

7

- Election Equipment: \$2,706
- Vote Safe Laptop: \$88
- Judges/Clerks: \$1,121

- Total: \$3,915

DISCUSSION



City of Killeen

Legislation Details

File #: DS-18-103 **Version:** 1 **Name:** Discuss Heritage Oaks Hike & Bike Trail
Type: Discussion Items **Status:** Discussion Items
File created: 11/27/2018 **In control:** City Council Workshop
On agenda: 12/4/2018 **Final action:**
Title: Discuss Heritage Oaks Hike & Bike Trail, Segment 5 Grant Funding
Sponsors: Public Works Department
Indexes:
Code sections:
Attachments: [Presentation](#)

Date	Ver.	Action By	Action	Result
------	------	-----------	--------	--------



HERITAGE OAKS HIKE & BIKE TRAIL SEGMENT 5 GRANT

DS-18-103

December 4, 2018



2

Project Limits

Background

- Heritage Oaks Hike & Bike Trail was added to the KTMPO Transportation Improvement Plan (TIP) in November 2015
- In 2016 Statewide Transportation Alternatives Program funds were awarded for a portion of the project from Platinum Drive to Chaparral Road which is currently under construction
- In 2017 the TIP was amended to break project into segments based on allocated funds
 - Segment 5, Chaparral Road to USACE property, was awarded funding in the amount of \$1.3M.
- Completing the project with the available funds, required letting schedule, permitting, and right-of-way acquisition is not feasible

Background

- The total project cost is estimated to be \$4M.
- The project is located outside of the city limits.
- The necessary environmental approvals and ROW acquisition are estimated to push the project beyond the allowable let date.
- City staff is recommending that the project be placed into a long range unfunded status with KTMPO until such time it is deemed appropriate to construct the project.
- This action does not require a formal City Council action; however, staff wanted to allow an opportunity for comment on the action prior to moving forward with the request.

Next Steps

5

- City staff will answer any questions on the project.
- If there is no objection, this item will be presented to the KTMPO Technical Advisory Committee on December 5, and the Transportation Planning Policy Board for final action on December 12.



City of Killeen

Legislation Details

File #: DS-18-104 **Version:** 1 **Name:** City Manager Updates
Type: Discussion Items **Status:** Discussion Items
File created: 9/26/2018 **In control:** City Council Workshop
On agenda: 12/4/2018 **Final action:**
Title: City Manager Updates
· Discuss Fees Associated with Downtown Development
Sponsors: City Manager Department
Indexes:
Code sections:
Attachments:

Date	Ver.	Action By	Action	Result
------	------	-----------	--------	--------



City of Killeen

Legislation Details

File #: DS-18-105 **Version:** 1 **Name:** Receive Legal Advice Regarding the Award of a Construction Contract for the South Water Supply Project

Type: Discussion Items **Status:** Discussion Items

File created: 11/28/2018 **In control:** City Council Workshop

On agenda: 12/4/2018 **Final action:**

Title: Receive Legal Advice Regarding the Award of a Construction Contract for the South Water Supply Project

Sponsors: City Manager Department

Indexes:

Code sections:

Attachments:

Date	Ver.	Action By	Action	Result
------	------	-----------	--------	--------



City of Killeen

Legislation Details

File #: RQ-18-012 **Version:** 1 **Name:** Future Agenda Item Requests
Type: Future Agenda Requests **Status:** Future Agenda Items
File created: 11/2/2018 **In control:** City Council Workshop
On agenda: 12/4/2018 **Final action:**
Title: Future Agenda Item Requests:
· Status Update of Governing Standards and Expectations Requirement for Ethics Policy, Standards of Conduct, and Disclosure Statement
Sponsors: City Council
Indexes:
Code sections:
Attachments:

Date	Ver.	Action By	Action	Result
------	------	-----------	--------	--------



City of Killeen

Legislation Details

File #: MN-18-028 **Version:** 1 **Name:** Minutes of November 27, 2018
Type: Minutes **Status:** Minutes
File created: 11/16/2018 **In control:** City Council Workshop
On agenda: 12/4/2018 **Final action:**
Title: Consider Minutes of Regular City Council Meeting of November 27, 2018.
Sponsors: City Secretary
Indexes:
Code sections:
Attachments: [Minutes](#)

Date	Ver.	Action By	Action	Result
------	------	-----------	--------	--------

City of Killeen
Regular City Council Meeting
Killeen Utilities Collections Conference Room
November 27, 2018 at 5:00 p.m.

Presiding: Mayor Jose Segarra

Attending: Mayor Pro Tem Jim Kilpatrick, Councilmembers, Butch Menking, Juan Rivera, Gregory Johnson, Shirley Fleming, Debbie Nash-King and Steve Harris

Also attending were City Manager Ron Olson, City Attorney Kathryn Davis, City Secretary Lucy Aldrich, and Sergeant-at-Arms Gilman.

Mayor Pro Tem Kilpatrick gave the invocation, and Councilmember Menking led everyone in the Pledge of Allegiance.

Approval of Agenda

Motion was made by Mayor Pro Tem Kilpatrick to approve the agenda as written. Motion was seconded by Councilmember Fleming. The motion carried unanimously.

Minutes

Motion was made by Councilmember Menking to approve the minutes of the November 13, 2018 Regular City Council Meeting. Motion was seconded by Councilmember Rivera. Motion carried unanimously.

Resolutions

- RS-18-103** Consider a memorandum/resolution amending an Interlocal Agreement with the Texas General Land Office for electricity services.
- Staff Comments:** Leslie Hinkle, Executive Director of Community Development. Ms. Hinkle gave provided brief background information as it pertains to the Texas General Land Office (GLO) and the services they provide to the City. GLO is represented by Cavallo Energy Texas, LLC and provides marketing, wholesale and retail support for GLO (since 2009). Through active management, the City's electricity price has declined steadily since 2008. Natural gas supplies and renewable resources has created an opportunity to secure additional savings in lower electricity rates and, at this time, the City can leverage historically low energy prices with market dynamics by extending the contract with GLO and Cavallo to secure future savings. Staff recommends that City Council authorize the City Manager or his designee to execute an amendment that allows the Texas GLO with Cavallo to extend the City of Killeen's Interlocal Agreement up to 36 months, from July 1, 2023 to no later than June 30, 2026, at or below a target price of \$.03775/kWh if market conditions allow. Staff further recommends that City Council authorize the City Manager or his designee and Texas GLO with Cavallo to blend electricity prices from all current contract terms to begin realizing cost savings in the current fiscal year.

Motion was made by Councilmember Rivera to approve RS-18-103. Motion was seconded by Councilmember Fleming. Motion carried unanimously.

RS-18-104 Consider a memorandum/resolution authorizing the award of Bid No. 19-07 for Uniform Services.

Staff Comments: Jon Locke, Executive Director of Finance

Mr. Locke gave a brief overview of the agenda item. Two vendors submitted proposals in response to the request for bids. The proposals were evaluated based on ten categories with Cintas being the lowest bidder and scoring as the best value. The contract being awarded under this bid will be for a term of three years with the option to renew for two additional one year periods. Staff recommends that City Council award Bid 19-07, Uniform Services, to Cintas for the City's uniform services through the U.S. Communities Cooperative Contract Program, and that the City Manager or designee be authorized to execute any change orders as permitted by state and local law.

Motion was made by Councilmember Fleming to approve RS-18-104. Motion was seconded by Councilmember Rivera. Motion carried unanimously.

RS-18-105 Consider a memorandum/resolution authorizing the award of Bid No. 19-05, Downtown Streetscaping Phase II Project, for a construction contract to Barsh Company.

Staff Comments: David Olson, Executive Director of Public Works.

Mr. Olson gave a brief overview of the agenda item. Two vendors submitted proposals in response to the request for bids. Staff recommends that the City Council authorize the City Manager or designee to enter into an agreement with Barsh Company for a construction contract to construct the Downtown Streetscaping Phase II project in the amount of \$440,227.90, and that the City Manager or designee is expressly authorized to execute any and all changes within the amounts set by state and local law.

Motion was made by Mayor Pro Tem Kilpatrick to approve RS-18-105. Motion was seconded by Councilmember Fleming. Motion carried 6 to 1 with Councilmember Johnson in opposition.

Ordinances

OR-18-013 Consider an ordinance authorizing the update of Texas Municipal Retirement System service credits.

The City Secretary read the caption of the ordinance.

AN ORDINANCE AUTHORIZING AND ALLOWING, UNDER THE ACT GOVERNING THE TEXAS MUNICIPAL RETIREMENT SYSTEM, "UPDATED SERVICE CREDITS" IN SAID SYSTEM FOR SERVICE PERFORMED BY QUALIFYING MEMBERS OF SUCH SYSTEM WHO PRESENTLY ARE MEMBERS OF THE CITY OF KILLEEN; PROVIDING FOR INCREASED PRIOR AND CURRENT SERVICE ANNUITIES FOR RETIREES AND BENEFICIARIES OF DECEASED RETIREES OF THE CITY; AND ESTABLISHING AN EFFECTIVE DATE FOR SUCH ACTIONS.

Staff Comments: Eva Bark, Executive Director of Human Resources. Updated service credits allow an employee's TMRS retirement benefits to reflect inflation and provides for increased prior and current service annuities for retirees and beneficiaries of deceased retirees of the City. If adopted, all employees covered under TMRS will have their retirement benefits recalculated based on a three-year average of their most recent salary. The FY 2019 budget assumes the 11.15% rate and associated costs. City staff recommends that the proposed ordinance updating the TMRS service credits be adopted with an effective date of January 1, 2019.

Motion was made by Councilmember Rivera to approve OR-18-013. Motion was seconded by Councilmember Fleming. Motion carried unanimously.

OR-18-014 Consider an ordinance amending the number of authorized civil service positions for the Killeen Police Department.

The City Secretary read the caption of the ordinance.

AN ORDINANCE OF THE CITY COUNCIL OF KILLEEN, TEXAS, TO AUTHORIZE THE NUMBER OF POLICE DEPARTMENT CIVIL SERVICE EMPLOYEES TO COMPLY WITH THE PROVISIONS OF TEXAS LOCAL GOVERNMENT CODE §143.021; PROVIDING FOR A REPEALER CLAUSE; PROVIDING FOR A SEVERABILITY CLAUSE; PROVIDING FOR PUBLICATION AND EFFECTIVE DATE.

Staff Comments: Eva Bark, Executive Director of Human Resources. Ms. Bark gave a brief background of the civil service system and identified that during the FY 2019 budget process, City Council approved the reduction of two positions that were and had been vacant for some time. This action is administrative in nature bringing the decisions that were made when the FY 2019 budget was adopted into compliance with law. Staff recommends that the City Council approve the ordinance amending the number of authorized Civil Service Police positions for the Killeen Police Department as aligned in the FY 2019 budget.

Motion was made by Mayor Pro Tem Kilpatrick to approve OR-18-014. Motion was seconded by Councilmember Menking. Motion carried unanimously.

OR-18-015 Consider an ordinance amending the Killeen Code of Ordinances Chapter 11, "Fire Prevention and Protection" by adopting the 2018 International Fire Code, as amended, and Appendix D, pertaining to Fire Apparatus Access Roads.

The City Secretary read the caption of the ordinance.

AN ORDINANCE OF THE CITY COUNCIL OF THE CITY OF KILLEEN, TEXAS, AMENDING VARIOUS SECTIONS OF CHAPTER 11 OF THE CODE OF ORDINANCES OF THE CITY OF KILLEEN; ADOPTING THE 2018 INTERNATIONAL FIRE CODE; ADOPTING APPENDIX D TO THE 2018 INTERNATIONAL FIRE CODE; PROVIDING FOR A REPEAL OF CONFLICTING PROVISIONS; PROVIDING FOR A SEVERABILITY CLAUSE; PROVIDING FOR A SAVINGS CLAUSE; PROVIDING FOR PUBLICATION AND AN EFFECTIVE DATE.

Staff Comments: Brian Brank, Fire Chief.

The 2018 International Fire Code is the most current version of fire and life safety standards/methods available. By keeping current with new fire codes the community is afforded the safest buildings in which to live and work. Currently, Killeen is enforcing the 2009 and portions of the 2015 International Fire Code. Adoption of the 2018 International Fire Code including Appendix D will update to the most current version. City staff recommends approval as submitted.

Motion was made by Councilmember Menking to approve OR-18-015. Motion was seconded by Councilmember Rivera. Motion carried unanimously.

OR-18-016 Consider an ordinance amending various sections and fees in Chapter 8 of the Code of Ordinances and adopting the 2018 International Construction Codes, the 2017 National Electrical Code and local amendments.

The City Secretary read the caption of the ordinance.

AN ORDINANCE AMENDING VARIOUS SECTIONS OF CHAPTER 8 OF THE CODE OF ORDINANCES OF THE CITY OF KILLEEN, ADOPTING THE 2018 INTERNATIONAL CONSTRUCTION CODES; ADOPTING LOCAL AMENDMENTS TO THE 2018 INTERNATIONAL CONSTRUCTION CODES; ADOPTING THE 2017 NATIONAL ELECTRICAL CODE; PROVIDING FOR REPEAL OF CONFLICTING PROVISIONS; PROVIDING FOR A SEVERABILITY CLAUSE; PROVIDING FOR A SAVINGS CLAUSE; PROVIDING FOR PUBLICATION AND AN EFFECTIVE DATE.

Staff Comments: Earl Abbott, Building Official.

By updating and adopting current building construction codes, the community is afforded safer buildings in which to live and work. Designers and builders have access to newer construction materials and methods and property owners are afforded lower insurance rates due to improved ISO insurance ratings. New construction codes become available in three year cycles. Currently, Killeen is enforcing the 2015 International Construction Codes and 2014 National Electrical Codes which went into effect January 1, 2016. On October 11, 2018, the Building Inspections staff and the Killeen Construction Board invited members of the local homebuilder's association and the general public to participate in a public hearing to jointly review the changes between the existing and proposed new construction codes and to review minor local changes. The Killeen Construction Board of Appeals and City staff recommends that City Council adopt the 2018 International Construction Codes, the 2017 National Electrical Code, and proposed amendments to Chapter 8 of the Code of Ordinances.

Motion was made by Councilmember Fleming to approve OR-18-016. Motion was seconded by Councilmember Rivera. Motion carried 6 to 1 with Councilmember Johnson in opposition.

Public Hearings

PH-18-035 **HOLD** a public hearing to provide citizens the opportunity to comment, and City Council to discuss and consider the Interlocal Agreement and application of the Edward Byrne Memorial Justice Assistance Grant (JAG) for FY 2018.

Staff Comments: Charles Kimble, Police Chief

The program award is allocated through an Interlocal Agreement between Bell County, City of Killeen, and the City of Temple: JAG funding for Fiscal Year 2018 will be \$82,370 with the City of Killeen receiving \$41,596. Funds will be used for equipment to outfit a Mobil Field Force designed to provide rapid, organized and disciplined response to civil disorder, crowd control or other major incidents. Staff recommends that City Council approve the submission of the 2018 Edward Byrne Memorial Justice Assistance Grant through the Killeen Police Department on behalf of all parties involved; the City Manager to sign the Interlocal Agreement; and to permit the Killeen Police Department to allocate and administer the duties required by the grant.

Mayor Segarra opened the public hearing.

With no one appearing, the public hearing was closed.

Motion was made by Councilmember Rivera to approve PH-18-035. Motion was seconded by Councilmember Fleming. Motion carried unanimously.

PH-18-036A Consider a memorandum/resolution authorizing the procurement of fleet replacement vehicles and equipment.

Staff Comments: Jon Locke, Executive Director of Finance

The criteria used to establish a vehicle replacement schedule is based upon available funding, units per category, age, mileage/hours, repair costs, and department/division feedback. The existing vehicles identified to be replaced are on average 15 years of age and have an average of 160,000 miles. There is a total of 40 pieces of fleet being procured that span over two budget cycles FY 2018 and FY 2019. Funds are available in the FY 2019 budget for the respective fleet replacement. The FY 2018 will require a budget amendment that follows this action item. Staff recommends that City Council approve the procurement of the fleet as stated above and that the City Manager or designee be authorized to execute any change orders as permitted by state and local law.

Motion was made by Mayor Pro Tem Kilpatrick to approve PH-18-036A. Motion was seconded by Councilmember Menking. Motion carried unanimously.

PH-18-036B HOLD a public hearing and consider an ordinance amending the FY 2019 Annual Budget and Plan of Municipal Services of the City of Killeen by increasing revenue and expenditure accounts for the purchase of fleet.

The City Secretary read the caption of the ordinance.

AN ORDINANCE OF THE CITY COUNCIL OF THE CITY OF KILLEEN, TEXAS,
AMENDING THE FY 2019 ANNUAL BUDGET AND PLAN OF MUNICIPAL SERVICES
OF THE CITY OF KILLEEN BY INCREASING REVENUE AND EXPENDITURE
ACCOUNTS FOR THE PURCHASE OF FLEET; REPEALING ALL ORDINANCES OR

PARTS OF ORDINANCES IN CONFLICT WITH THIS ORDINANCE; PROVIDING A SAVING CLAUSE; AND ESTABLISHING AN EFFECTIVE DATE.

Staff comments: Jon Locke, Executive Director of Finance.

The annual fleet replacement budget for FY 2018 was \$4,444,596. Not all of the vehicles approved to be replaced in the FY 2018 schedule were replaced during the fiscal year. The budgets for these vehicles and equipment must be carried forward into FY 2019. Fleet Services is prepared to procure 18 pieces of fleet that were approved as part of the FY 2018 fleet replacement schedule. The total cost of the fleet is \$1,293,309. Staff recommends that City Council approve the ordinance amending the FY 2019 Annual Budget and Plan of Municipal Services.

Mayor Segarra opened the public hearing.

With no one appearing, the public hearing was closed.

Motion was made by Mayor Pro Tem Kilpatrick to approve PH-18-036B. Motion was seconded by Councilmember Menking. Motion carried unanimously.

Adjournment

With no further business, upon motion being made by Councilmember Menking, seconded by Councilmember Harris, and unanimously approved, the meeting was adjourned at 6:08 p.m.



City of Killeen

Legislation Details

File #: RS-18-106 **Version:** 1 **Name:** Rental Car Lease Agreements-KFHRA
Type: Resolution **Status:** Resolutions
File created: 11/19/2018 **In control:** City Council Workshop
On agenda: 12/4/2018 **Final action:**
Title: Consider a memorandum/resolution to approve the Killeen Fort Hood Regional Airport rental car agreements.
Sponsors: Aviation Department
Indexes:
Code sections:
Attachments: [Staff Report](#)
[Avis Agreement](#)
[Alamo Agreement](#)
[Clearwater Agreement](#)
[Enterprise Agreement](#)
[Hertz Agreement](#)
[Certificate of Interested Parties](#)
[Presentation](#)

Date	Ver.	Action By	Action	Result
------	------	-----------	--------	--------



STAFF REPORT

DATE: December 4, 2018

TO: Ronald L. Olson, City Manager

FROM: Matthew Van Valkenburgh A.A.E., Executive Director of Aviation

SUBJECT: APPROVAL OF RENTAL CAR LEASE AGREEMENTS FOR KILLEEN FORT HOOD REGIONAL AIRPORT

BACKGROUND AND FINDINGS:

The Killeen-Fort Hood Regional Airport leases retail facilities in the terminal building to various businesses to provide appropriate services to the public as well as to provide revenue sources for the airport enterprise fund. The existing rental car leases were approved in 2011 for a five (5) year term and, per that agreement, an additional two (2) years through September 2018.

The Airport began negotiations with the rental cars in summer 2018, and based upon the age and scope of the existing agreement, developed, with a consultant, an up-to-date agreement which is industry standard. Staff released Bid 19-06 in October 2018 and received bid packages in November 2018 from Avis Budget Car Rental LLC, Clearwater Transportation, Ltd., EAN Holdings, LLC d/b/a Enterprise Rent-A-Car Company, EAN Holdings, LLC d/b/a Alamo Rent a Car and National Car Rental, and The Hertz Corporation. All bid packages are in compliance with bid requirements and all bidding companies are eligible to execute agreements to operate at the Airport. The new agreement is for a single term of five (5) years with no extensions and will commence on January 1, 2019.

THE ALTERNATIVES CONSIDERED:

Alternatives considered: (1) approve the agreements, or (2) do not approve the agreements.

Which alternative is recommended? Why?

Staff recommends alternative 1. Approval of the agreements will provide (1) continued exceptional rental car service for Airport customers, and (2) a consistent revenue source for the Airport for the next (5) years

CONFORMITY TO CITY POLICY:

Yes

FINANCIAL IMPACT:

Total annual revenue to the Killeen-Fort Hood Regional Airport Enterprise Fund represented by these lease agreements is approximately \$800,000 in account number 525-0000-324.05-05

AIRPORT RENT & CONCESSION/RENTAL CARS, and \$450,000 in account number 526-0000-324.52-00 CUSTOMER FACILITY CHARGES.

What is the amount of the expenditure in the current fiscal year? For future years?

N/A

Is this a one-time or recurring expenditure?

N/A

Is this expenditure budgeted?

N/A

If not, where will the money come from?

N/A

Is there a sufficient amount in the budgeted line-item for this expenditure?

N/A

RECOMMENDATION:

Council approve the rental car agreements with the aforementioned companies and authorize the City Manager or designee to execute same as well as any and all amendments as allowed per federal, state, or local law.

DEPARTMENTAL CLEARANCES:

Finance
Legal

ATTACHED SUPPORTING DOCUMENTS:

Avis Agreement
Alamo Agreement
Clearwater Agreement
Enterprise Agreement
Hertz Agreement
Certificate of Interested Parties

CONCESSION AGREEMENT

NON-EXCLUSIVE RENTAL CAR CONCESSION
Killeen - Fort Hood Regional Airport
Killeen, Texas

between

Killeen - Fort Hood Regional Airport
City of Killeen, Texas

and

Avis Budget Car Rental, LLC

<u>Section</u>	<u>Page</u>
DEFINITIONS	6
SECTION 1 – LEASED PREMISES.....	9
SECTION 2 – TERM	9
SECTION 3 – USES, PRIVILEGES, COBRANDING AND OBLIGATIONS	9
SECTION 4 – RESTRICTIONS ON USES AND PRIVILEGES.....	11
SECTION 5 – PRIVILEGE FEE, RENTS, FEES AND ACCOUNTING RECORDS.....	11
Subsection 5.1 Privilege Fee, Rent and Fees.	11
Subsection 5.2 Statements, Books, and Records; Delinquent Rentals.	16
Subsection 5.3 Audit.....	17
SECTION 6 – INSTALLATION OF IMPROVEMENTS AND DESIGN, FURNISHING, AND EQUIPPING OF PREMISES	17
Subsection 6.1 Building Services	17
Subsection 6.2 Approval of Plans and Specifications; Provision of Drawings.....	17
SECTION 7 – TITLE TO IMPROVEMENTS, STRUCTURAL ALTERATIONS, ETC.	19
Subsection 7.1 Title.....	19
Subsection 7.2 Structural Alterations.....	19
Subsection 7.3 Alterations and Improvements to Airport.....	19
Subsection 7.4 Removal and Demolition.....	19
SECTION 8 – MAINTENANCE OF PREMISES	19
Subsection 8.1 Airport Maintenance Obligations.	19
Subsection 8.2 Concessionaire's Maintenance Obligations.	20
SECTION 9 – LIENS, PAYMENT, AND PERFORMANCE BONDS.....	21
Subsection 9.1 Construction Surety Bond.	21
Subsection 9.2.....	22
Subsection 9.3.....	22

SECTION 10 – OPERATION OF LEASED PREMISES: HOURS AND DELIVERIES	22
Subsection 10.1 Hours of Operation.....	22
Subsection 10.2 Delivery of Goods.	22
Subsection 10.3 Utilities.	23
SECTION 11 – QUALITY AND CHARACTER OF SERVICE.....	23
Subsection 11.1 Type of Operation.	23
Subsection 11.2 Services to the General Public.....	23
Subsection 11.3 Additional Compliance.	23
Subsection 11.4 Personnel.....	23
SECTION 12 – NON-DISCRIMINATION.....	24
SECTION 13 – IDEMNIFICATION AND INSURANCE.....	24
Subsection 13.1 Indemnification.....	24
Subsection 13.2 Concessionaire to Provide General Liability and Automobile Insurance.	25
Subsection 13.3 Concessionaire to Provide Property and Fire Insurance.....	25
Subsection 13.4 Both Concessionaire and City to Carry Fire Insurance.	25
Subsection 13.5 Insurance Certificate.	26
Subsection 13.6 Concessionaire Failure to Provide Certificates.	26
SECTION 14 – DAMAGE OR DESTRUCTION OF LEASED PREMISES	26
Subsection 14.1 Partial Damage.	26
Subsection 14.2 Extensive Damage.....	27
Subsection 14.3 Complete Destruction.	27
Subsection 14.4 Limits of City's Obligations Defined.....	27
SECTION 15 – CANCELLATION	27
Subsection 15.1 Cancellation by Concessionaire.....	27
Subsection 15.2 Cancellation by City.	28
Subsection 15.3 Termination.	29
Subsection 15.4 Notice of Termination.....	29
SECTION 16 – NONWAIVER OF RIGHTS	29
SECTION 17 – SURRENDER OF POSSESSION	29
SECTION 18 – TAXES AND LICENSES	29

SECTION 19 – INSPECTION OF PREMISES	30
SECTION 20 – HOLDING OVER	30
SECTION 21 – QUIET ENJOYMENT	30
SECTION 22 – NO LIENS.....	30
SECTION 23 – SECURITY AGREEMENTS	30
SECTION 24 – AGREEMENT SUBORDINATE TO AGREEMENTS WITH THE UNITED STATES	31
SECTION 25 – RIGHTS AND PRIVILEGES OF CITY	31
SECTION 26 – ACCESS CONTROL	32
SECTION 27 – NO PERSONAL LIABILITY	33
SECTION 28 – GOVERNING LAW.....	33
SECTION 29 – NOTIFICATION	33
SECTION 30 – SEVERABILITY	34
SECTION 31 – ASSIGNMENT, SUBLET, AND TRANSFER	34
SECTION 32 – NO WAIVER.....	34
SECTION 33 – CONFLICTS OF INTEREST	34
SECTION 34 – POLITICAL ACTIVITIES.....	34
SECTION 35 – ENTIRE AND SUPERSEDING AGREEMENT	35

SECTION 36 – AMENDMENT	35
SECTION 37 – TIME COMPUTATION	35
SECTION 38 – NOTICES	35
SECTION 39 – CONSTRUCTION.....	36
SECTION 40 – NO THIRD PARTY BENEFICIARY	36
SECTION 41 – COMPLIANCE WITH LAW	36
SECTION 42 – FORCE MAJEURE.....	36
SECTION 43 – GOOD STANDING.....	36
SECTION 44 – INDEPENDENT CONTRACTORS	37
SECTION 45 – GOVERNMENTAL APPROVALS.....	37
SECTION 46 – AUTHORITY.....	37
SECTION 47 – COUNTERPARTS.....	37
SECTION 48 – SURVIVAL.....	37
SECTION 49 – MORE FAVORABLE TERMS.....	37
SECTION 50 – ENVIRONMENTAL.....	38
SECTION 51 – ISRAEL CLAUSE	40
EXHIBIT A1 - COUNTER/OFFICE/QUEUING AREAS	42
EXHIBIT A2 - READY/RETURN BLOCKS AND SERVICE BAYS	43

EXHIBIT A3 – STORAGE AREA..... 43

EXHIBIT A4 – OVERFLOW PARKING LANES..... 44

EXHIBIT B..... 45

RENTAL CAR CONCESSION
Killeen - Fort Hood Regional Airport
Killeen, Texas

THIS CONCESSION AGREEMENT ("**Agreement**"), made and entered into this 1st day of January, 2019, by and between the City of Killeen (the "**City**"), a municipal corporation and existing under the laws of the State of Texas, whose address is 8101 S. Clear Creek Rd, Box C, Killeen, Texas 76549, hereinafter referred to as "City" and "Avis Budget Group" operating as Avis Budget Car Rental, LLC, (hereinafter referred to as "**Concessionaire**"), a limited liability company with its office and address being 6 Sylvan Way, Parsippany, NJ 07054, with a mailing address 6 Sylvan Way, Parsippany, NJ 07054.

WITNESSETH:

WHEREAS, City controls, owns, operates, and maintains an airport in the City of Killeen, County of Bell, State of Texas, known as Killeen - Fort Hood Regional Airport (hereinafter referred to as "Airport"), and has the power to grant rights and privileges with respect thereto, and

WHEREAS, the City has determined it to be in the best interests of the public and the City to enter into this Agreement with Concessionaire to provide rental car concession services at the Airport pursuant and subject to the terms and conditions hereunder,

NOW, THEREFORE, THE PARTIES AGREE:

DEFINITIONS

The following terms and phrases shall have the following meanings for purposes of this Agreement:

1. "ACDBE" shall mean airport concession disadvantaged business enterprise as that term is defined by 49 CFR Part 23.
2. "City" shall mean the municipal corporation existing under the laws of the State of Texas which controls, operates, and maintains the Killeen - Fort Hood Regional Airport.
3. "Environmental Law" shall mean any federal, state or local law, rule, regulation, order or requirement relating to protection of human health and safety or the environment.
4. "Executive Director of Aviation" shall mean the Executive Director of Aviation of the City's Airport, or his or her designee.
5. "Gross Revenues" as used herein shall mean, as determined in the reasonable discretion of the City, all amounts charged to its customers by Concessionaire for or

in connection with agreements it secures through its operations and business at the Airport, regardless of whether such amount is actually paid to or received by Concessionaire. Gross Revenues shall include all monies or other consideration of whatsoever nature paid or payable to Concessionaire by customers for all sales made and services performed for cash, credit or consideration in connection with automobile and vehicle rentals or other products or services provided to persons through Concessionaire's operations at the Airport, without regard to the ownership, area, fleet, or location assignment of vehicles and without regard to the manner in which or place at which the vehicles or other products or services are furnished to Concessionaire's customers and without regard to whether the vehicles or other products are returned to the Airport or to some other location.

Gross Revenues shall include anything and everything that is not specifically excluded. The only exclusions from Gross Revenues permitted under this Agreement shall be the specific exclusions set forth below:

- Federal, state, county, city or municipal sales, use, or excise taxes now in effect or hereinafter levied on Concessionaire's operations which are separately stated on customers' rental contracts and collected from customers of Concessionaire;
 - Those fees referred to in this Agreement as Customer Facility Charges, "CFCs" which for the purpose of this Agreement shall include all customer facility charges, authorized pursuant to City Resolution, as may be amended;
 - Amounts received specifically for the actual loss of or damages of vehicles or other property of Concessionaire;
 - Amounts received from the sale of vehicles off-Airport premises; provided, however, any amounts paid in connection with automobile and vehicle rentals or other products or services provided to persons through Concessionaire's operations that are applied to or otherwise reimbursed as a result of the sale of a vehicle shall not be excluded from Gross Revenues; and
 - Reimbursements for amounts actually paid for speeding tickets, parking tickets, red light tickets, tolls and toll violations, and towing and impound fees from its customers to pass through without markup to an independent third party with no amount being retained by Concessionaire. However, any amounts collected above the pass through amount shall be included as Gross Revenue under this Agreement.
6. "Hazardous Material" shall mean any material that, because of its quantity, concentration or physical or chemical characteristics, is deemed by any federal, state or local governmental authority to pose a present or potential hazard to human health or safety or to the environment, and includes any material or substance

identified, listed, or defined as a "hazardous waste" "hazardous substance," or "pollutant" or "contaminant" or term of similar import, or is otherwise regulated pursuant to Environmental Laws, including any asbestos and asbestos-containing materials; petroleum, including crude oil or any fraction thereof, natural gas or natural gas liquids.

7. "Leasehold Improvements" shall mean all improvements and equipment which are affixed to the Leased Premises and which cannot be removed without material damage to the Premises.
8. "Operations Year" shall mean January 1 through December 31 annually.
9. "Personal Property" shall mean all movable property of the Concessionaire not directly related to the rental car operations of the privileges granted hereunder, including, office furniture, office equipment, and office supplies.
10. "Refurbish" or "Refurbishment" shall mean the routine repainting or redecoration of public areas within the Leased Premises, as necessary, including the replacement or repair of worn carpet, tile, furniture, or furnishings.
11. "Rental Car" or "Motor Vehicles" shall mean motor vehicles designed primarily for the carriage of passengers and commonly classified as sedans, coupes, convertibles, station wagons, four-wheel drive vehicles, passenger vans, sport utility vehicles, and pick-up trucks rated one-ton or less. Concessionaire shall not park, store, or rent from Premises any vehicles except Motor Vehicles as defined herein that it owns or rents and are properly available for rental as provided herein.
12. "Terminal Building" shall mean the terminal building at the Airport.
13. "Trade Fixtures" shall mean all non-affixed items, except expendables and Personal Property, which can be removed without damage to the Leased Premises, including cash registers, safes, patron tables and chairs, display fixtures, and the like.
14. "Transaction" shall mean the execution of an agreement or contract for the rental of a Motor Vehicle; or, the payment of funds or completion of a cash or credit transaction for payment for rental of a Motor Vehicle; or delivery of a Motor Vehicle to a customer for use in exchange for cash, credit or any other consideration.
15. "Transaction Day" shall mean each twenty-four (24) hour period or portion thereof, for which a customer of a Rental Car concessionaire rents, or otherwise enters into a similar arrangement for the use of a Motor Vehicle and for which the Rental Car concessionaire collects revenue from the customer. Late returns (after twenty four (24) hours) shall be considered a Transaction Day.

SECTION 1 – LEASED PREMISES

- A. City hereby leases to Concessionaire and Concessionaire hereby agrees to lease from City the following premises, which, collectively, are hereinafter called the "Leased Premises": Four Hundred and Eight (408) square feet of counter/office/queuing area "A" in the terminal building, Block "RR-3" the ready return area containing approximately thirty-six (36) ready/return parking spaces outside and adjacent to the terminal building, Service Bay "2" and the associated queuing lane, and Storage Area "D". Said Leased Premises is more particularly shown on **Exhibits A1, A2, and A3** attached hereto and by this reference made a part hereof.
- B. Concessionaire agrees that its Leased Premises have been inspected by Concessionaire and are accepted and will be occupied by Concessionaire on an "as is" basis. The Concessionaire specifically waives any covenants or warranties regarding the Premises, including but not limited to any warranty of suitability and warranty of fitness.

SECTION 2 – TERM

The term of this Agreement is for a five (5) year period commencing on January 1, 2019 and terminating on December 31, 2023 unless sooner terminated or canceled as hereinafter provided.

SECTION 3 – USES, PRIVILEGES, COBRANDING AND OBLIGATIONS

Concessionaire shall have the following uses, privileges, and obligations in connection with its use of the Leased Premises:

- A. The non-exclusive right, privilege, and obligation to conduct and operate a rental car, van or truck rental concession at the Airport. Co-Branding by Concessionaire is limited to two brands per concession space specifically those listed in their submitted proposal. It being understood that no more than two brands under rental car agencies which are owned by the same parent company may operate from any one concession space during the term of this agreement. Concessionaire understands and agrees that it shall not engage in any other business on the Airport under this Agreement.
- B. The right, privilege, and obligation to rent and check-in rental vehicles, including the right to offer for sale related collision damage waiver protection, personal injury and accident insurance, personal effects insurance, and such other travel or vehicle related coverage offered in connection with and incidental to the rental of a vehicle and occupy operations office, storage, and Ready and Return car parking spaces. It is the intent of this Agreement that rental car customers of Concessionaire will operate the vehicle rented only from the ready spaces provided herein, and Concessionaire shall not engage in customer shuttle operations of any kind to, from, or on the Airport. This does not prohibit the

picking up of a customer from the Fixed Base Operator (FBO). No trucks larger than ¾ ton pickup type/style will be allowed in the ready lot unless approved in writing in advance by the Executive Director of Aviation.

- C. The non-exclusive right and privilege to wash vehicles rented by Concessionaire under the provisions of this Agreement in the City's car wash.
- D. The right and privilege to service vehicles rented by the Concessionaire under the provisions of this Agreement in the service bay identified in Section 1. Concessionaire shall use the service bay for the following activities only: vehicle automated and hand washing, cleaning, fluid replacement, vacuuming, and related activities as are necessary for preparing its vehicles for rental. No washing or vehicle maintenance may be conducted in the rental car parking lot or overflow parking areas.
- E. The right of ingress and egress to and from the Premises, over Airport roadways, is subject to such reasonable rules and regulations as may be established by Airport as respecting such use and subject to law.
- F. Concessionaire shall install no signs on or about the Premises without the prior written approval of the Executive Director of Aviation, said approval being solely discretionary with the Executive Director of Aviation. For purposes of this Section, signs shall include, but not necessarily be limited to, identification signs, company logos, advertising or promotions, photographs, art displays, and the like. Such signs shall be substantially uniform in size, types and location with those of other concessionaries, and subject to Executive Director of Aviation's approval, Rules and Regulations, and in compliance with all applicable laws and resolutions. No temporary signs or displays shall be permitted on the backwall or the counter surfaces without the prior written approval of the Executive Director of Aviation. Handwritten, or hand lettered signs are prohibited. Concessionaire shall not place or install any racks, stands, trade fixtures, pedestal signs, or other displays of products outside the boundaries of the Leased Premises without the express prior written approval of the Executive Director of Aviation.
- G. The right for Concessionaire's employees, in common with other employees of tenants of the Terminal Building, to use vehicular parking space provided by City, subject to the payment of reasonable charges therefore, as set by the City.
- H. *Airport Concession Disadvantaged Business Enterprise Program*
 - 1. This agreement is subject to the requirements of the U.S. Department of Transportation's regulations, 49 CFR Parts 23 and 26 related to the airport concession disadvantaged business enterprises (ACDBE) program. The concessionaire or contractor agrees that it will not discriminate against any business owner because of the owner's race, color, national origin, or sex in connection with the award or performance of any concession

agreement, management contract, or subcontract, purchase or lease agreement, or other agreement covered by 49 CFR Part 23.

2. The concessionaire or contractor agrees to include the above statements in any subsequent concession agreement or contract covered by 49 CFR Part 23, that it enters and cause those businesses to similarly include the statements in further agreements.
3. Each year Concessionaire no later than (90) days following end of each Operational Year shall provide to City the following annual ACDBE information: the name and address of each certified ACDBE with which it has done business during the past year, a description of the nature of the services performed by and/or items purchased from each firm named, and the dollar value of each transaction.

SECTION 4 – RESTRICTIONS ON USES AND PRIVILEGES

The Leased Premises shall be used only for the purposes specified in this Agreement. Concessionaire understands and agrees that City has the right to grant up to five additional privileges under separate agreements for in-terminal rental car operations to other companies.

Prohibited Activities at the service bay include:

- A. Concessionaire shall not utilize the service bay for vehicle storage other than vehicles for rent in the process of being serviced.
- B. Concessionaire shall not utilize the service bay for any maintenance or for the storage of damaged vehicles.
- C. Concessionaire shall not allow its customers or the general public to enter the service bay.
- D. Concessionaire shall not permit its employees to vacuum, wash or fuel their personal vehicles or vehicles not part of the Concessionaire's fleet at the service bay or fueling area.

SECTION 5 – PRIVILEGE FEE, RENTS, FEES AND ACCOUNTING RECORDS

Subsection 5.1 Privilege Fee, Rent and Fees.

- A. *Privilege Fee.* As consideration for the privilege of operating the concession hereunder, Concessionaire shall pay to City each contract year, for the full term of this Agreement, a Privilege Fee. Said Privilege Fee shall be the greater of either the guaranteed Minimum Annual Privilege Fee or the Percentage Fee applicable to Gross Revenue, hereinafter defined, as follows:

1. Privilege Fee – the greater of either:
 - a. ten percent (10%) of the Concessionaire’s annual Gross Revenues (“Percentage Privilege Fee”);

OR

- b. the respective yearly amount shown below as the Concessionaire’s Minimum Annual Guaranteed fee (“MAG”):

January 1, 2019 to December 31, 2019	\$	126,375.00
January 1, 2020 to December 31, 2020	\$	128,925.00
January 1, 2021 to December 31, 2021	\$	131,550.00
January 1, 2022 to December 31, 2022	\$	134,175.00
January 1, 2023 to December 31, 2023	\$	136,800.00

2. Monthly payment shall be the greater of 1/12th of the respective year’s MAG or 10% of reported gross revenues for the previous month. The MAG payment shall be paid in advance on the first (1st) day of each month during each Operations Year, until such time as the Concessionaire has paid to the Airport an amount equal to the respective annual MAG identified in Section 5.1(A)(1)(b) above. On or before the 20th of each month the Concessionaire shall provide the Airport with: i) a signed and certified Report of Gross Revenues for the preceding month and ii) payment of any percentage Privilege Fee shown to be due for the preceding month, as designated on Exhibit B, attached hereto and made a part hereof. Once the sum of Privilege Fee payments remitted has reached the MAG in any given Operations Year, the Concessionaire may cease remittance of the 1/12th of the respective year’s MAG on the first (1st) day of each month for the remainder of that Operations Year. The Concessionaire shall continue to report and remit each and every month after the annual MAG has been reached the full 10% of reported gross revenues for the previous month.
3. In the event of a major traffic reduction at GRK, during the term of this Agreement, the MAG hereinabove provided for in this Section 5.1(A) above shall be abated for the period of time the condition exists. A major traffic reduction at GRK shall be defined as a twenty five percent (25%) reduction in the number of passengers deplaning on scheduled airline flights at GRK during any period of three (3) consecutive calendar months as compared to the number of such deplaning passengers in the same calendar months during the preceding calendar year.
4. Concessionaire acknowledges that Privilege Fee payments by Concessionaire to City under this Agreement are for Concessionaire’s privilege to use the Airport facilities and access the Airport market and are not fees imposed by City upon Concessionaire’s customers. City does not require, but will not prohibit, a separate statement of and charge for the Privilege Fee on customer invoices or rental agreements (“Recovery

Fee”), provided that such Recovery Fee meets all of the following conditions: (a) such Recovery Fee must be titled “Concession Recovery Fee,” “Concession Recoupment Fee” or such other name first approved by the Executive Director of Aviation in writing; (b) the Recovery Fee must be shown on the customer rental car agreement and invoiced with other Concessionaire charges (i.e. “above the line”); (c) the Recovery Fee as stated on the invoice and charged to the customer shall be no more than 11.11% of Gross Revenues and shall be specifically included in the Definition of Gross Revenues for purposes of remittance to City; (d) Concessionaire shall neither identify, treat, or refer to the Recovery Fee as a tax, nor imply that City is requiring the pass through of such fee; (e) Concessionaire shall comply with all applicable laws, including Federal Trade Commission requirements, any Texas Consumer Protection legislation and any commitment to or contractual obligation by Concessionaire with any governmental agency or officer with authority over Concessionaire’s activities.

B. Rent -

1. Rent for Premises

Concessionaire shall pay to the City, in advance, on the 1st day of each month, one twelfth the following annual rents or the monthly rent as applicable:

- a) For the period commencing January 1, 2019 through December 31, 2019, Concessionaire shall pay the sum of Twenty-five Dollars and Thirty-two Cents (\$25.32) per square foot per annum for Four Hundred and Eight (408) square feet of counter/office/queuing position in the Terminal Building. On January 1 of each year for the period of this Agreement, commencing January 1, 2020, the rental amounts for the counter/office/queuing space, shall be adjusted in accordance with the Consumer Price Index – National Index for All Urban Consumers for the previous calendar year. Said adjustment shall be computed as follows:

$$\begin{aligned} &\text{Most recent year's rate x} \\ &\quad (\text{CPI for November of most recent year} / \\ &\quad \text{CPI for November of the next most recent year}) = \text{New Rate} \end{aligned}$$

- b) For the period commencing January 1, 2019 through December 31, 2019, Concessionaire shall pay the sum of Twenty-five Thousand Nine Hundred and Twenty Dollars (\$25,920), per annum for Ready Return Block “RR-3” as shown on Exhibit A2. On January 1 of each year for the period of this Agreement, commencing January 1, 2020, the rental amounts for the parking block, shall be adjusted in accordance with the Consumer Price Index – National Index for All

Urban Consumers for the previous calendar year, as described above.

- c) For the period commencing January 1, 2019 through December 31, 2019, Concessionaire shall pay the sum of Four Thousand Eight Hundred Dollars (\$4,800), per annum for service bay “2” as shown on Exhibit A2. On January 1 of each year for the period of this Agreement, commencing January 1, 2020, the rental amounts for the service bay, shall be adjusted in accordance with the Consumer Price Index – National Index for All Urban Consumers for the previous calendar year, as described above.
- d) For the period commencing January 1, 2019 through December 31, 2019, Concessionaire shall pay the sum of One Thousand Two Hundred Dollars (\$1,200), per annum for storage area “D” as shown on Exhibit A3. On January 1 of each year for the period of this Agreement, commencing January 1, 2020, the rental amounts for the storage area, shall be adjusted in accordance with the Consumer Price Index – National Index for All Urban Consumers for the previous calendar year, as described above.
- e) If requested by Concessionaire, overflow parking lanes as agreed upon with the Executive Director of Aviation on a month to month basis in the amount of \$150 per lane per month through December 31, 2019. On January 1 of each year for the period of this Agreement, commencing January 1, 2020, the rental amounts for the overflow parking lanes, shall be adjusted in accordance with the Consumer Price Index – National Index for All Urban Consumers for the previous calendar year, as described above. Overflow lanes are shown on Exhibit A4.

C. Additional Fees –

- 1. The Concessionaire shall collect the CFCs on behalf of the Airport and remit to the Airport, in accordance with the City’s CFC resolution, the full amount of the Transaction Day fee collected from each Rental Car customer.
- 2. The Concessionaire shall pay to the City for telephone system/service access to the Internet via a T-1 as follows:

Local service	\$23.50 per line per month
Voice mail	\$4.25 per line per month
Phone rental	\$6.00 per phone per month
Maintenance fee	\$15.50 per line per month

Above telecommunication fees are subject to change as determined by the City. Payment shall be due within thirty (30) days of invoice date.

3. The Concessionaire shall pay to the City a per wash fee of \$2.00 per automated wash. The Concessionaire shall pay to the City, for use of the manual car wash, a rate of \$1.25 per 5 minute session.

Car wash fees are subject to change as determined by the City with advance written notice. Payment shall be due within thirty (30) days of invoice date.

4. The Concessionaire shall pay to the City, based on actual gallons of fuel pumped, a per gallon fuel rate equal to the City's purchase price of the fuel plus \$0.15 cents, as may be adjusted by the City with advance written notice.

Payment shall be due within thirty (30) days of invoice date.

5. If the Concessionaire's bid reflected the operation of two brands in its concession, Concessionaire shall pay to the City a fee of One Thousand Dollars (\$1,000) per month which shall be paid in advance on the first (1st) of each month.
6. Additional fees may include charges for special items or activities including, but not limited to, employee parking, monthly electronic access card fees, badging fees, and disposal of debris left in service bay area and assigned parking areas. The City may assess reasonable, non-discriminatory and cost-recovery based charges for these special items or activities. All new charges will be reviewed with Concessionaire prior to implementation. Other charges payable by Concessionaire shall be paid by Concessionaire to City no later than thirty (30) days following receipt by Concessionaire of billing therefor.
7. Concessionaire shall be charged, at the current short term parking rate, for any of its vehicles found to be parked in a parking space not specifically leased by the Concessionaire or without the approval of the Executive Director of Aviation.

D. Any and all payments due to the City by Concessionaire shall be remitted to the following address:

City of Killeen Finance Department
Attn: Accounts Receivable
P.O. Box 1329
Killeen, TX 76540

E. Year End Adjustments to Privilege Fees, Rents and Fees.

In the event the amount of payments made during the preceding Operations Year exceeds the total of any payments due for such Operations Year, the excess payment shall be credited against the payments for the next Operations Year, except that any excess payment during the final Operations Year of this Agreement will be returned to the Concessionaire within thirty (30) days after the Airport's acceptance of the final Certified Statement described in this Section. Concessionaire shall submit separate system generated reports for each brand name operated.

Subsection 5.2 Statements, Books, and Records; Delinquent Rentals.

- A. Monthly Statements; Books and Records. Within twenty (20) days after the close of each calendar month of the term of this Agreement, Concessionaire shall submit to City, in such detail and on the statement form designated as Exhibit B or as may reasonably be specified by City, certain information, including but not limited to, the number of Transactions executed during the preceding month, the number of Transaction Days Motor Vehicles were rented during the preceding month, and the statement of its Gross Revenues during the preceding month upon which the percentage payments to City set forth in Subsection 5.1 A(1) are to be computed, and said Exhibit B statement to be signed by a responsible accounting officer of Concessionaire. City reserves the right to change the form of the monthly statement and to require the submission by Concessionaire of other information pertaining to the Gross Revenues hereunder, and Concessionaire agrees to change the form of its statements to that requested by City and to provide any such additional information City may reasonably request. Concessionaire shall keep full and accurate books and records showing all of its Gross Revenues hereunder, and City shall have the right, through its representatives and at reasonable times, at its own expense, to inspect, examine, copy, and audit such books and records, including State of Texas sales tax return records. Concessionaire hereby agrees that all such books and records will be made available to City for at least three (3) years following the period covered by such books and records.
- B. Annual Certified Statements. Each year during the term of this Agreement, Concessionaire shall provide to City a written statement, certified by an independent Certified Public Accountant, to City stating that in his or her opinion the Percentage Fees paid by Concessionaire to City during the preceding year pursuant to this Agreement were made in accordance with the terms of this Agreement. Said statement shall be submitted by Concessionaire, to be received by City within ninety (90) days of the end of each contract year. Such statement shall also contain a list of the Gross Revenues, by month, as shown on the books and records of Concessionaire and which were used to compute the Percentage Fee payments made to City during the period covered by said statement.

- C. Delinquent Rentals and Fees. Without waiving any other right or action available to City in the event of default in the payment of charges or fees payable to City, pursuant to this Agreement, a late fee of one and a half percent (1.5%) of the total amount due will be assessed to the Concessionaire if payments prescribed above are not received by the dates prescribed therein. An additional one and a half percent (1.5%) of the outstanding amount will be assessed each month that all or a portion of the Concessionaire's obligations remain unpaid.

Subsection 5.3 Audit. City reserves the right to audit Concessionaire's books and records pertaining to the Leased Premises, at its own expense, at any time for the purpose of verifying the Gross Revenues, Privilege Fee and CFC calculation hereunder for any period three (3) years prior to such audit. If, however, as a result of such audit, it is established that Concessionaire has understated the Gross Revenues received from all operations at the Leased Premises by two percent (2%) or more (after the deductions and exclusions herein), the entire expense of said audit shall be borne by Concessionaire. Any additional Privilege Fee due shall forthwith be paid by Concessionaire to City with interest thereon at one and one-half percent (1.5%) per month from the date such additional Privilege Fee became due.

SECTION 6 – INSTALLATION OF IMPROVEMENTS AND DESIGN, FURNISHING, AND EQUIPPING OF PREMISES

Subsection 6.1 Building Services

- A. City Improvements and Services. City shall initially insure and provide occupancy of the Leased Premises to Concessionaire with said Leased Premises meeting all federal, state and local code requirements for the operation of a rental car concession. City shall provide and maintain water, sewer, general lighting, electrical power, heating and air-conditioning, and telephone system/service access to the Internet via a T-1 for the Terminal Building. Heating and air conditioning, electrical service, and telephone system/service access to the Internet via T-1 are provided to the Leased Premises only. If Concessionaire requires additional lighting, electrical power, water, or adjustments to the air-conditioning system or telephone system, such additional improvements or services shall be subject to the prior written approval of Executive Director of Aviation, and any such approved improvements or services shall be made at Concessionaire's expense.
- B. Concessionaire's Right to Additional Services. Concessionaire shall have the right, at its own expense, to request and receive additional services or systems, provided that any such services or systems shall require the written approval of Executive Director of Aviation before installation.

Subsection 6.2 Approval of Plans and Specifications; Provision of Drawings.

- A. General. Any improvements to be made to or upon the Leased Premises by Concessionaire, and any subsequent alterations or additions to such

improvements, shall be subject to the prior written approval of Executive Director of Aviation. Full and complete plans and specifications for all work, facilities, improvements, and finishes, and the time required to complete same, shall be submitted to and receive the written approval of Executive Director of Aviation before any work or construction is commenced, which shall not be unreasonably withheld or delayed. First-class standards of design and construction shall be complied with in connection with all such work, facilities, and improvements; and all construction shall conform to the general architectural requirements of Executive Director of Aviation as established for each improvement program. Two (2) copies of plans for all improvements or subsequent changes therein or alterations thereof shall be given to Executive Director of Aviation for review prior to commencement of construction; after final approval by Executive Director of Aviation, Executive Director of Aviation shall return to Concessionaire one (1) approved copy for Concessionaire's records and shall retain one (1) approved copy as an official record thereof.

- B. Improvements Conform to Statutes, Ordinances, Etc. All improvements, furniture, fixtures, equipment, and finishes, including the plans and specifications therefore, constructed or installed by Concessionaire, its agents, or contractors, shall conform in all respects to applicable statutes, ordinances, building codes, and rules and regulations, and public bidding laws. Any approval given by City shall not constitute a representation or warranty as to such conformity; responsibility therefore shall at all times remain with Concessionaire.
- C. Approvals Extend to Architectural and Aesthetic Matters. Approval of City shall extend to and include architectural and aesthetic matters and City reserves the right to reasonably reject any layout or design proposals submitted and to require Concessionaire to resubmit any such layout or design proposals until they meet Executive Director of Aviation approval.
- D. Disapprovals. In the event of disapproval by City of any portion of any plans or specifications, Concessionaire shall promptly submit necessary modifications and revisions thereof for approval by Executive Director of Aviation. City agrees to act promptly upon such plans and specifications and upon requests for approval of changes or alterations in said plans or specifications. No substantial changes or alterations shall be made in said plans or specifications after initial approval by City, and no alterations or improvements shall be made to or upon the Leased Premises without the prior written approval of Executive Director of Aviation.
- E. Provision of As-Built Drawings. Upon completion of any construction project, Concessionaire shall provide City two (2) completed sets of as-built drawings in reproducible form as specified by City. Concessionaire agrees that, upon the request of City, Concessionaire will inspect the Leased Premises jointly with City to verify the as-built drawings.

SECTION 7 – TITLE TO IMPROVEMENTS, STRUCTURAL ALTERATIONS, ETC.

Subsection 7.1 Title. All improvements made to the Leased Premises by Concessionaire, and any additions and alterations thereto made by Concessionaire, shall be and remain the property of Concessionaire until the termination of this Agreement (whether by expiration of the term, cancellation, forfeiture or otherwise), at which time said improvements, except for Trade Fixtures, personal property, and expendables, shall become the property of City, at no cost to City.

Subsection 7.2 Structural Alterations. Concessionaire shall make no structural alterations to the Leased Premises without the prior written consent of Executive Director of Aviation.

Subsection 7.3 Alterations and Improvements to Airport. Concessionaire acknowledges that from time to time City may undertake construction, repair, or other activities related to the operation, maintenance and repair of the Terminal Building which may temporarily affect Concessionaire's operations hereunder. Concessionaire agrees to accommodate City in such matters, even though Concessionaire's own activities may be inconvenienced, and Concessionaire agrees that no liability shall attach to City, its members, employees, or agents by reason of such inconvenience or impairment. It is agreed that in the event such activities of City substantially impair the operations of Concessionaire under this Agreement, the Minimum Privilege Fee shall be waived during such period of substantial impairment, with what constitutes "substantial impairment" being reasonably determined by Executive Director of Aviation after consultation with Concessionaire. Concessionaire agrees that if relocation is required that Concessionaire shall move its operations as reasonably directed by Executive Director of Aviation.

Subsection 7.4 Removal and Demolition. Concessionaire shall not remove or demolish, in whole or in part, any Leasehold Improvements upon the Leased Premises without the prior written consent of City which may, at its sole discretion, condition such consent upon the obligation of Concessionaire, at Concessionaire's cost, to replace the same by an improvement specified in such consent.

SECTION 8 – MAINTENANCE OF PREMISES

Subsection 8.1 Airport Maintenance Obligations.

- A. General Maintenance and Operation. City agrees that it will, with reasonable diligence, maintain, operate, and keep in good repair the Airport, including the Terminal Building and all appurtenances, facilities, and services now or hereafter connected therewith. Airport shall keep the car rental parking lot and the overflow parking area in suitable repair, and provide general lighting for these areas.
- B. Structural Maintenance. City shall provide, or cause to be provided, structural

maintenance of the Terminal Building.

- C. **Maintain Access.** City shall, throughout the term of this Agreement, maintain all airport-owned roads on the Airport giving access to the Terminal Building in good and adequate condition for use by cars and trucks and shall maintain free and uninterrupted access to the Terminal Building over said road at all times. City reserves the right to reasonably restrict access to the Terminal Building area for automobile deliveries during peak activity periods.
- D. **Car Wash.** City will maintain and inspect the car wash facilities as recommended by the manufacturer including routine maintenance of the car wash for normal activities, wear and tear. Normal and routine maintenance of roofs, walls, utility infrastructure, building mechanical systems and structural building components will be performed by City. Wash soaps, rinses, brushes, hoses, and utilities will be provided by the City. City has the exclusive authority to stop the use of the car wash for maintenance and inspections as is necessary, at City's sole discretion, without damage or liability to Concessionaire. City will take reasonable action to notify Concessionaire for closure of the car wash.
- E. **Telephone System/Service Access to the Internet via a T-1.** The Airport shall furnish telephone system/service access to the Internet via a T-1. Rates for these services will be in accordance with Section 5.1(C). A letter of agreement or other suitable document will be executed between the Airport's Executive Director of Aviation or his/her designated representative and the local designated representative of the Concessionaire to document exactly which services are agreed to between the two parties. Airport reserves the right to change or terminate said telephone and/or internet service at some point during the term of this Agreement. Airport will provide at least a ninety (90) day notice to Concessionaire of any service changes and assist in facilitating replacement services via a local communication provider.

Subsection 8.2 Concessionaire's Maintenance Obligations.

- A. **Concessionaire's General Obligations.** Except for maintenance of the Terminal Building, Car Wash, and Telephone System, as provided in Subsection 8.1, Concessionaire shall be obligated, without cost to City, to maintain the Leased Premises and every part thereof in good appearance, repair, and safe condition. Concessionaire shall maintain and repair all Leasehold Improvements on the Leased Premises and all furnishings, fixtures, and equipment therein, whether installed by Concessionaire or by others, including repainting or redecorating as necessary, and replacing or repairing worn carpet, tile, fixtures, or furnishings. All such maintenance and repairs shall be at least of quality equal to the original in materials and workmanship, and all work, including paint colors, shall be subject to the prior written approval of Executive Director of Aviation. Concessionaire shall be obligated, without cost to City, to provide custodial service to Leased

Premises. Concessionaire shall be responsible for the replacement cost of lost keys and floor finish restoration.

- B. Hazardous Conditions. Upon discovery, Concessionaire shall immediately give oral notice to Airport of any hazardous or potentially hazardous conditions in the Leased Premises or in the Terminal Building. Any hazardous or potentially hazardous condition in the Leased Premises shall be corrected immediately upon receipt of oral notice from the Executive Director of Aviation. At the direction of said Director, Concessionaire shall close the Leased Premises until such hazardous or potentially hazardous condition is removed.
- C. Trash and Refuse. City shall provide, at no cost to Concessionaire, a container for the adequate sanitary handling of all trash and other refuse caused as a result of the operation of the Leased Premises. Concessionaire shall be responsible for disposal of its own trash accumulations by depositing it in the nearest exterior trash dumpster on a daily basis. Concessionaire will regularly inspect exterior areas assigned to them and will remove all trash and debris. Failure to do so will result in the City completing this task and a fee assessed to the Concessionaire for the service. Trash receptacles inside the terminal building are for customer use only. Piling of boxes, cartons, barrels, or other similar items in view of a public area is prohibited. Concessionaire shall keep any areas used for trash and garbage storage prior to removal from Airport in a reasonably clean and orderly condition so as not to unduly attract rodents, pests, or birds, or create an offensive odor. Concessionaire also agrees to participate in the City's recycling program by depositing all recyclable products in the appropriate outside recycling containers in lieu of the trash dumpster.
- D. Transporting Trash and Refuse. In transporting trash and refuse from the Leased Premises, Concessionaire shall ensure that trash is not strewn around while taking refuse to the dump site. Such disposal shall take place during hours as may be approved by the City.
- E. Damage to Equipment. Concessionaire will be responsible for the cost of replacement equipment deemed to be damaged by their employees due to negligence.

SECTION 9 – LIENS, PAYMENT, AND PERFORMANCE BONDS

Subsection 9.1 Construction Surety Bond. Concessionaire shall not allow any liens or encumbrances to be attached to the Leased Premises. Prior to the commencement of any construction or alteration hereunder which exceeds \$10,000 in cost, Concessionaire or its contractor shall furnish to City, and without expense to City, a surety bond, issued by a surety company licensed to transact business in the State of Texas and satisfactory to and approved by City with Concessionaire's contractor or contractors as principals, in a sum not less than

one hundred percent (100%) of the total cost of the contract or contracts for the construction or alteration of the improvements and facilities mentioned herein. Said bond shall guarantee the prompt payment to all persons supplying labor, materials, provisions, supplies, and equipment used directly or indirectly by said contractor, subcontractor(s), and suppliers in the prosecution of the work provided for in said construction contract and shall protect City from any liability, losses, or damages arising there from.

Subsection 9.2 Compliance with Federal Aviation Regulations, 14 CFR Part 139, and Transportation Security Administration security requirements 49 CFR Part 1542. Concessionaire agrees to comply with Federal Aviation Regulations, and 1542 (Airport Security), U.S. Army requirements, and the City's policies as outlined in City's approved Operations Plan and Airport Security Plan. Concessionaire further agrees that any fines levied upon the City or Concessionaire through enforcement of these regulations because of acts by Concessionaire's employees, agents, suppliers, guests, or patrons shall be borne by Concessionaire to the extent said acts contributed to said fines.

Subsection 9.3 Security. During the term of this Agreement, the City shall require the Operator to deliver (and thereafter maintain current for the entire term of this Agreement) an instrument of security in a form satisfactory to the City, in its sole discretion, in the amount of twenty-five percent (25%) of Concessionaire's Minimum Annual Guarantee for each year hereunder, in order to secure the performance of all of Concessionaire's obligations under this Agreement, including without limitation, the payment of all the percentages, minimums, fees, charges and costs set out herein. Said security may be in the form of a bond.

SECTION 10 – OPERATION OF LEASED PREMISES: HOURS AND DELIVERIES

Subsection 10.1 Hours of Operation. Concessionaire shall actively operate in the Leased Premises and shall use a business-like operation therein. The Concessionaire shall be open to serve the public seven (7) days per week and hours of operation shall be such that passengers of flights arriving or departing from the terminal will be accommodated. In no event shall the hours of operation be curtailed to an extent that the service contemplated under this Agreement shall be diminished. Except as otherwise stated herein, the hours of service shall be determined in light of changing public demands and airline operating schedules. Concessionaire may advise the Executive Director of Aviation of Concessionaire's analysis of the optimum arrangements, but the final determination shall be made by the Executive Director of Aviation based on their analysis of necessary service to the public.

Subsection 10.2 Delivery of Goods. Concessionaire shall arrange for the timely delivery of all motor vehicles and supplies, at such times, in such locations(s), and by such routes as determined by City. Concessionaire shall abide by all Transportation Security Administration (TSA) requirements for parking of motor vehicles near the terminal building.

Subsection 10.3 Utilities.

- A. City shall provide the Leased Premises with heat and air-conditioning to keep the Leased Premises at reasonable temperatures for the conduct of Concessionaire's activities. City shall have the right to set, monitor, adjust and restrict thermostat settings to levels it determines to be appropriate.
- B. City shall provide electricity to the Leased Premises by means of wiring installations, and Concessionaire shall make such connections as required and permitted by building code. At no time shall Concessionaire's use of electric current exceed the capacity of the wiring installation in place.

SECTION 11 – QUALITY AND CHARACTER OF SERVICE

Subsection 11.1 Type of Operation. Concessionaire shall maintain and operate the concession privileges granted hereunder in an orderly, proper, and first-class manner, which, in the sole judgment of Executive Director of Aviation, does not unduly annoy, disturb, or offend others at the Airport.

Subsection 11.2 Services to the General Public. Concessionaire understands and agrees that its operation at the Airport necessitates the rendering of public services such as giving directions, and generally assisting the public.

Subsection 11.3 Additional Compliance. Concessionaire shall comply with all applicable governmental laws, ordinances, and regulations in the conduct of its operations under this Agreement.

Subsection 11.4 Personnel.

- A. General. Concessionaire shall maintain a sufficient number of properly trained personnel to ensure that all customers of Concessionaire receive prompt and courteous service. All such personnel, while on or about the Leased Premises, shall be polite, clean, appropriately attired, and neat in appearance. Clothing will be neat and clean and present a professional appearance. Executive Director of Aviation shall have the right to object to the demeanor, conduct, and appearance of any employee of Concessionaire, or any of its invitees or those doing business with it, whereupon Concessionaire shall take all steps necessary to remedy the cause of the objection. Concessionaire will ensure that its counter is staffed at all times during the posted hours of operation.
- B. Manager. The management, maintenance, and operation of the Leased Premises and the concession conducted thereon shall be at all times during the term hereof under the supervision and direction of an active, qualified, competent, and experienced manager, who shall at all times be authorized to represent and act for Concessionaire. Concessionaire shall cause such

manager to be available during normal business hours, and Concessionaire will at all times during the absence of such manager assign, or cause to be assigned, a qualified subordinate to assume and be directly responsible for the carrying out of his or her duties.

SECTION 12 – NON-DISCRIMINATION

This agreement is subject to the requirements of the U.S. Department of Transportation's regulations, 49 CFR Part 23, pursuant to law, it is unlawful and Concessionaire agrees not to willfully refuse to employ, to discharge, or to discriminate against any person otherwise qualified because of race, color, religion, sex, sexual orientation, age, disability, national origin or ancestry, lawful source of income, marital status, creed, or familial status; not to discriminate for the same reason in regard to tenure, terms, or conditions of employment, not to deny promotion or increase in compensation solely for these reasons; not to adopt or enforce any employment policy which discriminates between employees on account of race, color, religion, sex, creed, age, disability, national origin or ancestry, lawful source of income, marital status or familial status; not to seek such information as to any employee as a condition of employment; not to penalize any employee or discriminate in the selection of personnel for training, solely on the basis of race, color, religion, sex, sexual orientation, age, disability, national origin or ancestry, lawful source of income, marital status, creed or familial status.

Concessionaire shall include or cause to be included in each subcontract covering any of the services to be performed under this Agreement a provision similar to the above paragraph, together with a clause requiring such insertion in further subcontracts that may in turn be made.

SECTION 13 – IDEMNIFICATION AND INSURANCE

Subsection 13.1 Indemnification. To the fullest extent allowable by law, Concessionaire hereby indemnifies and shall defend and hold harmless, at Concessionaire's expense, City, its elected and appointed officials, committee members, officers, employees or authorized representatives or volunteers, from and against any and all suits, actions, legal or administrative proceedings, claims, demands, damages, liabilities, losses, interest, attorney's fees (including in-house counsel legal fees), costs and expenses of whatsoever kind, character or nature whether arising before, during, or after completion of the Agreement hereunder and in any manner directly or indirectly caused or contributed to in whole or in part, by reason of any act, omission, fault, or negligence, whether active or passive of Concessionaire, or of anyone acting under its direction or control or on its behalf in connection with or incident to the performance of this Agreement, regardless if liability without fault is sought to be imposed on City. Concessionaire's aforesaid indemnity and hold harmless agreement shall not be applicable to any liability caused by the negligent or willful misconduct of City, its elected and appointed officials, officers, employees or authorized representatives or volunteers. Nothing in this Agreement shall be construed as City waiving its statutory limitation and/or immunities as set forth in the applicable Texas

Statutes or other applicable law. This indemnity provision shall survive the termination or expiration of this Agreement.

Concessionaire shall reimburse City, its elected and appointed officials, officers, employees or authorized representatives or volunteers for any and all legal expenses and costs incurred by each of them in connection therewith or in enforcing the indemnity herein provided. Concessionaire's obligation to indemnify shall not be restricted to insurance proceeds, if any, received by City, its elected and appointed officials, officers, employees or authorized representatives or volunteers.

To the extent allowed by law, except for damage or injury caused by the willful or negligent act or omission of Concessionaire, its agents or employees, City shall indemnify, defend and save Concessionaire, its agents, representatives, and employees from any and all lawsuits, claims, loss and damages of any nature whatsoever, including damage to property of any Concessionaire and the injury, including death, of employees, agents, or customers of Concessionaire, arising either directly or indirectly out of any operations of the City hereunder, except lawsuits, claims, loss and damages arising out of the sole negligence of the Concessionaire, their employees, or agents.

Subsection 13.2 Concessionaire to Provide General Liability and Automobile Insurance. Concessionaire shall, at its sole expense, obtain and maintain in effect at all times during this Agreement the following insurance coverage:

- A. Commercial General Liability Insurance of not less than \$5,000,000 per occurrence for bodily injury, personal injury and property damage;
- B. Automobile Insurance of not less than \$5,000,000 per occurrence;
- C. To the extent that Concessionaire employs any employees or as otherwise required by law, Workers' Compensation and Employers' Liability Insurance with Texas statutory limits.

Subsection 13.3 Concessionaire to Provide Property and Fire Insurance. Concessionaire, at its own expense, shall insure all Leasehold Improvements and furnishings, fixtures and equipment for fire, extended coverage, vandalism, and malicious mischief. Such insurance shall be in an amount equal to the full insurable replacement value of such improvements. All property insurance policies shall contain loss payable endorsements in favor of the parties as their respective interests may appear hereunder and shall contain a waiver of subrogation provision in favor of the City. Concessionaire and City agree that any payments received by either from such insuring companies by reason of loss under such policy or policies shall be applied toward repair and reconstruction of said Leasehold Improvements and repair or replacement of leasehold improvements, furnishings, fixtures and equipment.

Subsection 13.4 Both Concessionaire and City to Carry Fire Insurance. It is understood that both Concessionaire and City carry insurance in the form of fire, extended coverage, vandalism, and malicious mischief (hereinafter called "Insurance

Coverage") on the leased structural part of the premises, permanent improvements and loss of income, (in the case of City) and on Leasehold Improvements, furniture, furnishings, equipment, inventory and loss of income, (in the case of Concessionaire), and said Insurance Coverage authorizes a waiver of subrogation between City and Concessionaire, and the parties wish to enter into such waiver of subrogation to the extent of the said Insurance Coverage; therefore, to the extent that City collects under its Insurance Coverage, City waives any and all claims against Concessionaire, its agents, servants, and employees, for loss or damage to City's property resulting from risks included in said Insurance Coverage; and, to the extent that Concessionaire collects under its Insurance Coverage, Concessionaire waives any and all claims against City, its agents, servants, and employees, for loss or damage to Concessionaire's property resulting from risks included in said Insurance Coverage. If this waiver by the parties shall render fully any such insurance policy or shall result in the denial of coverage for a party under such policy, then the provision paragraph shall be deemed to be null and void.

Subsection 13.5 Insurance Certificate. A certificate evidencing insurance required by Subsection 13.2 and 13.3, and listing the City of Killeen as additional insured, excluding Workers' Compensation and Property and Fire Insurance, shall be filed with City prior to the commencement of construction, furnishing and equipping of Leasehold Improvements by Concessionaire upon the Leased Premises, and such certificate shall provide that such Insurance Coverage will not be canceled or reduced without at least thirty (30) days prior written notice to City. Prior to the expiration of any such policy, a certificate showing that such Insurance Coverage has been renewed shall be filed with City. If such Insurance Coverage is canceled or reduced, Concessionaire shall within fifteen (15) days after receipt of written notice from City of such cancellation or reduction in coverage, file with City a certificate showing that the required insurance has been reinstated or provided through another insurance company or companies.

Subsection 13.6 Concessionaire Failure to Provide Certificates. In the event that Concessionaire shall at any time fail to furnish City with the certificate or certificates required under this Section, City, upon written notice to Concessionaire of its intention so to do, shall have the right to obtain the required insurance, at the cost and expense of Concessionaire, and Concessionaire agrees to promptly reimburse City for the cost thereof, plus fifteen percent (15%) thereof for administrative overhead.

SECTION 14 – DAMAGE OR DESTRUCTION OF LEASED PREMISES

Subsection 14.1 Partial Damage. If all or a portion of the Leased Premises is partially damaged by fire, explosion, the elements, public enemy, or other casualty, but not rendered untenable, the same will be repaired with due diligence by City subject to the limitations of Subsection 14.4; provided, however, to the extent that such damage or destruction is not covered by insurance, Concessionaire shall be responsible for reimbursing City for the cost and expenses insured in such repair to the extent that the damage is caused by the negligent act or omission of Concessionaire, its sublessees, agents, or employees.

Subsection 14.2 Extensive Damage. If the damages referred to in Subsection 14.1 shall be so extensive as to render the Terminal Building Premises untenable, but capable of being repaired in thirty (30) days, the same shall be repaired with due diligence by City subject to the limitations of Subsection 14.4; and the charges payable herein for the MAG and Rent under Section 5.1 shall abate from the time of such damage or destruction until such time as the said Leased Premises are fully restored and certified by City's Engineers as ready for occupancy; provided, however, the said fees and charges will not abate and to the extent that such damage or destruction is not covered by insurance, Concessionaire shall be responsible for reimbursing City for the cost and expenses incurred in such repair to the extent that the damage is caused by the negligent act or omission of Concessionaire, its sublessees, agents, or employees.

Subsection 14.3 Complete Destruction. In the event the Terminal Building Premises are completely destroyed by fire, explosion, the elements, the public enemy, or other casualty, or so damaged that they are untenable and cannot be replaced for more than thirty (30) days, City shall undertake the repair, replacement, and reconstruction of said Leased Premises; and charges payable herein for the MAG and Rent under Section 5.1, shall abate as of the time of such damage or destruction until such time as the said Premises are fully restored and certified by City's Executive Director of Aviation as ready for occupancy; provided, however, the said fees and charges will not abate and to the extent that such damage or destruction is not covered by insurance, Concessionaire shall be responsible for reimbursing City for the costs and expenses incurred in said repair to the extent that the damage is caused by the negligent act or omission of Concessionaire, its sublessees, agents, or employees; provided further, however, if within twelve (12) months after the time of such damage or destruction said Leased Premises shall not have been repaired or reconstructed, Concessionaire may cancel this Agreement in its entirety. Rents payable for the leased areas in the Terminal Building and/or Ready/Return Block will only abate if the City is unable to provide alternative space for Concessionaire to conduct its business.

Subsection 14.4 Limits of City's Obligations Defined. It is understood that, in the application of the foregoing Subsections, City's obligations shall be limited to repair or reconstruction of the Leased Premises to the same extent and of equal quality as obtained at the commencement of operations hereunder, subject to funding and appropriation. Redecoration and replacement of furniture, fixtures, equipment, and supplies shall be the responsibility of Concessionaire and any such redecoration and refurnishing/re-equipping shall be of equivalent quality to that originally installed hereunder.

SECTION 15 – CANCELLATION

Subsection 15.1 Cancellation by Concessionaire. Concessionaire may cancel this Agreement and terminate all its obligations hereunder upon or after the happening of one or more of the following events and provided that Concessionaire is not in default in the payment of any fees or charges to City:

- A. The abandonment of the Airport as an airline terminal or the removal of all certificated passenger airline service from the Airport for a period of no less than thirty (30) consecutive days.
- B. The inability of Concessionaire to use the Airport for a period of longer than ninety (90) days, because of the issuance of any order, rule, or regulation by any competent governmental authority or court having jurisdiction over Concessionaire or City, preventing Concessionaire from operating its business; provided, however, that such inability or such order, rule, or regulation is not primarily due to any fault of Concessionaire.
- C. The material breach by City in the performance of any covenant or agreement herein required to be performed by City and the failure of City to remedy such breach for a period of sixty (60) days after receipt from Concessionaire of written notice to remedy the same.

Subsection 15.2 Cancellation by City. City may cancel this Agreement and terminate all of its obligations hereunder at any time that City is not in default, upon or after the happening of any of the following events:

- A. Concessionaire shall file a voluntary petition in bankruptcy; or
- B. Proceedings in bankruptcy shall be instituted against Concessionaire and Concessionaire is thereafter adjudicated bankrupt pursuant to such proceedings; or
- C. A court shall take jurisdiction of Concessionaire and its assets pursuant to proceedings brought under the provisions of any federal reorganization act; or
- D. A receiver of Concessionaire's assets shall be appointed; or
- E. Concessionaire voluntarily abandons its conduct of its business at the Airport for a period of thirty (30) days, except if such is due to a labor strike or labor dispute in which Concessionaire is involved; or
- F. Any assignment is made by Concessionaire for the benefit of its creditors; or
- G. The material breach by Concessionaire of any of the covenants or agreements herein contained and the failure of Concessionaire to remedy such breach as hereinafter provided. In this regard it is understood that nonpayment of fees or charges hereunder is a material breach. In the event of such material breach, City shall give to Concessionaire notice in writing to correct such breach and if such breach shall continue for fifteen (15) days after the receipt of such notice by Concessionaire, City may, after the lapse of said fifteen (15) day period, cancel this Agreement, without forfeiture, waiver, or release of City's rights to any sum of money due or to become due under the provisions of this Agreement.

H. The lawful assumption by the United States Government, or any authorized agency thereof, of the operation, control or use of the Airport and facilities, or any substantial part or parts thereof, in such manner as to substantially restrict Concessionaire, for a period of at least thirty (30) days, from its Airport operation.

Subsection 15.3 Termination. Should an early termination of this Agreement occur pursuant to the terms of Subsection 15.2 hereof, City shall have the right to re-enter the Leased Premises, make repairs as necessary, and enter into another agreement for the Leased Premises and privileges, or any part thereof, for the remainder of the term hereof.

Subsection 15.4 Notice of Termination. If any of the events enumerated in Subsections 15.1 and 15.2 shall occur and after due notice the defaulting party has failed to cure or correct same, the complaining party may, at any time thereafter during the continuance of said default, terminate this Agreement by notice in writing, such cancellation and termination to be effective upon the date specified in such notice.

SECTION 16 – NONWAIVER OF RIGHTS

Continued performance by either party hereto pursuant to the terms of this Agreement after a default of any of the terms, covenants, and conditions herein contained to be performed, kept, or observed by the other party hereto shall not be deemed a waiver of any right to cancel this Agreement for any subsequent default; and no waiver of any such default shall be construed or act as a waiver of any subsequent default.

SECTION 17 – SURRENDER OF POSSESSION

Concessionaire shall, upon termination of this Agreement or cancellation, quit and deliver up the Leased Premises and privileges to City peaceably and quietly, with the Leased Premises being in as good order and condition as the same now are or may be hereafter improved by Concessionaire or City, reasonable use and wear thereof excepted. In addition to any lien provided by Texas law, City shall have a specific lien on all property of Concessionaire, and related equipment on the Leased Premises as security for nonpayment. Concessionaire shall have the right to remove all of its trade fixtures and equipment installed or placed by it at its own expense, in, on or about the Premises; subject however, to any valid lien which City may have thereon for unpaid charges or fees. Provided however, the City will not claim or have a lien of any kind, be it contractual or statutory, on or against Concessionaire's motor vehicles for non-payment of any rent or fees due under the Agreement, or for any default of Concessionaire or any other reason, and the City hereby waives all such liens available to the City.

SECTION 18 – TAXES AND LICENSES

Concessionaire shall obtain and pay for all licenses or permits necessary or required by

law for the construction of improvements, the installation of equipment and furnishings, and any other licenses necessary for the conduct of its operations hereunder.

SECTION 19 – INSPECTION OF PREMISES

City or its duly authorized representatives, or agents, and other persons for it, may enter upon said Leased Premises at any and all reasonable times during the term of this Agreement for the purpose and conditions hereof or for any other purpose incidental to rights of City.

SECTION 20 – HOLDING OVER

Should Concessionaire holdover said Leased Premises after this Agreement has terminated in any manner, Concessionaire shall continue such holding over only at sufferance to City. In the event of such holding over, Concessionaire shall pay to the City the amounts specified in Subsection 5.1, the amounts being the amounts in effect immediately prior to the commencement of such holdover.” All other terms and conditions in such holdover shall be the same as herein provided.

SECTION 21 – QUIET ENJOYMENT

City agrees that Concessionaire, upon payment of the fees and charges and all other payments to be paid by Concessionaire under the terms of this Agreement, and upon observing and keeping the agreements and covenants of this Agreement on the part of Concessionaire to be observed and kept, shall lawfully and quietly hold, occupy, and enjoy the Leased Premises during the term of this Agreement.

SECTION 22 – NO LIENS

Concessionaire shall pay for all labor done or materials furnished in the repair, replacement, development, or improvement of the Premises by Concessionaire, and shall keep said Leased Premises and Concessionaire's possessory interest therein free and clear of any lien or encumbrance of any kind whatsoever created by Concessionaire's act or omission.

SECTION 23 – SECURITY AGREEMENTS

City shall provide, or cause to be provided, during the term of this Agreement, all proper and appropriate public fire and police protection similar to that afforded to other Landside tenants or licensees at the Airport, and it will issue and enforce rules and regulations with respect thereto for all portions of the Airport. Concessionaire shall comply with the Airport Security Plan and shall have the right, but shall not be obligated, to provide such additional or supplemental public protection as it may desire, but such right, whether or not exercised by Concessionaire, shall not in any way be construed to limit or reduce the obligations of City hereunder.

SECTION 24 – AGREEMENT SUBORDINATE TO AGREEMENTS WITH THE UNITED STATES

This Agreement is subject and subordinate to the terms, reservations, restrictions, and conditions of any existing or future agreements between the City and the United States, the execution of which has been or may be required as a condition precedent to the transfer of federal rights or property to the City for Airport purposes, and the expenditure of federal funds for the extension, expansion, or development of the Killeen - Fort Hood Regional Airport. Should the effect of such Agreement with the United States government be to take any of the property under lease or substantially destroy the commercial value of such improvements, City shall terminate this Agreement.

SECTION 25 – RIGHTS AND PRIVILEGES OF CITY

- A. City shall have the right to enforce, and adopt from time to time, reasonable rules and regulations, which Concessionaire agrees to observe and obey, with respect to the use of the Airport, Airport Terminal Building and appurtenances, provided that such rules and regulations shall not be inconsistent with safety, current rules and regulations of the FAA, and any future changes prescribed from time to time by the FAA.
- B. The City Manager or designee is hereby designated as its official representative for the enforcement of all provisions in this Agreement with full power to represent City with dealings with Concessionaire in connection with the rights herein granted.
- C. All actions relating to policy determination, modification of this Agreement, termination of this contract, and any similar matters affecting the terms of this Agreement shall emanate from the City Council, their successors or assigns.
- D. The Executive Director of Aviation or designee may enter upon the Leased Premises, now or hereafter leased to Concessionaire hereunder, at any reasonable time, for any purpose necessary, incidental to, or connected with, the performance of its obligations hereunder, or in the exercise of its governmental functions.
- E. City reserves the right to further plan, develop, improve, remodel and/or reconfigure the Airport, including the Leased Premises and existing vehicle and pedestrian traffic patterns, as the City deems appropriate, regardless of the desires or views of Concessionaire, and without interference or hindrance.
- F. City hereby reserves for the use and benefit of the public, the right of aircraft to fly in the airspace overlying the land herein leased, together with the right of said aircraft to cause such noise as may be inherent in the operation of aircraft landing at, taking off from, or operating on or in the vicinity of Killeen - Fort Hood Regional Airport, and the right to pursue all operations of the Killeen - Fort Hood Regional Airport.

- G. City reserves the right to take any action it considers necessary to protect the aerial approaches of the Airport against obstruction, together with the right to prevent Concessionaire from erecting, or permitting to be erected, any building or other structure on the Airport, which, in the opinion of the City, would limit the usefulness of the Airport, or constitute a hazard to aircraft.
- H. City may from time to time increase the size or capacity of any such Public Aircraft Facilities or Passenger Terminal Building or Common Use Portion of the Airport or make alterations thereto or reconstruct or relocate them or modify the design and type of construction thereof or close them or any portions of them, either temporarily or permanently, provided notice is given to Concessionaire.
- I. This Agreement at any time may be reopened for renegotiation if Federal Aviation Administration (FAA) Airport Certification (FAR Part 139), Transportation Security Administration (TSA) Security Requirements (49 CFR, Part 1542), or U.S. Army regulations result in major expenditures to City due to Concessionaire's tenancy on the Killeen - Fort Hood Regional Airport. If said renegotiation is desired, written notice must be given to Concessionaire sixty (60) days prior to such renegotiations.
- J. City reserves the right to relocate the Leased Premises upon the completion of any Terminal area remodeling or expansion. City will not be liable for the costs associated with the moving or reinstallation of Concessionaire's equipment. In the event the City requires a move by the Concessionaire, the City will reimburse actual out-of-pocket costs associated with the relocation as approved in advance subject to a maximum amount as established by the City.

SECTION 26 – ACCESS CONTROL

- A. Concessionaire shall upon termination of this agreement return all issued keys and access cards to City. If all issued keys and access cards are not returned to City at the termination of this Agreement Concessionaire shall pay to City cost to re-core premises locks and cut new keys at the rate set at the time of such re-core and to pay for any lost access cards.
- B. Concessionaire is responsible for all keys and access cards issued to employees of Concessionaire. Concessionaire is responsible to insure every employee that has regular duty at the Airport is submitted for airport electronic access cards appropriate for that employee and that all employee data remains current. The Concessionaire will notify the appropriate representative of the Airport by telephone or other appropriate means as soon as possible following the termination of any employee, but will do so in writing no later than the end of the next working day after the employee's last day of employment at the Airport. The Concessionaire is further responsible for

returning the employee's electronic access cards no later than three (3) working days after the last day of employment at the Airport. Any lost electronic access cards must be reported in writing to the Airport's representative as soon as possible, but no later than the end of the next working day from the date of the loss. Concessionaire is responsible for any charges or damages incurred by the use of electronic access cards issued to its employees unless more than 24 hours (excluding weekends and City of Killeen recognized holidays) have passed from the time the Concessionaire provides written notification to the Airport's representative to cancel any access these electronic access cards allow. A monthly fee will be charged for active employee electronic access cards and for lost cards at the current rates adopted by the City.

- C. Concessionaire may not install additional locks or change locks to Leased Premises without the written approval of the Executive Director of Aviation.

SECTION 27 – NO PERSONAL LIABILITY

Under no circumstances shall any trustee, officer, official, commissioner, Director, member, partner or employee of City have any personal liability arising out of this Agreement, and Concessionaire shall not seek or claim any such personal liability.

SECTION 28 – GOVERNING LAW

This Agreement and all questions and issues arising in connection herewith shall be governed by and construed in accordance with the laws of the State of Texas. Venue for any action arising out of or in any way related to this Agreement shall be exclusively in Bell County, Texas. Each party waives its right to challenge venue.

SECTION 29 – NOTIFICATION

Concessionaire shall:

- A. As soon as possible and in any event within a reasonable period of time after the occurrence of any default, notify City in writing of such default and set forth the details thereof and the action which is being taken or proposed to be taken by Concessionaire with respect thereto.
- B. Promptly notify City of the commencement of any litigation or administrative proceeding that would cause any representation and warranty of Concessionaire contained in this Agreement to be untrue.
- C. Notify City, and provide copies, immediately, upon receipt, of any notice, pleading, citation, indictment, complaint, order or decree from any federal, state or local government agency or regulatory body, asserting or alleging a circumstance or condition that requires or may require a financial contribution by Concessionaire or any guarantor or an investigation, clean-up, removal,

remedial action or other response by or on the part of Concessionaire or any guarantor under any environmental laws, rules, regulations, ordinances or which seeks damages or civil, criminal or punitive penalties from or against Concessionaire or any guarantor for an alleged violation of any environmental laws, rules, regulations or ordinances.

SECTION 30 – SEVERABILITY

The provisions of this Agreement are severable. If any provision or part of this Agreement or the application thereof to any person or circumstance shall be held by a court of competent jurisdiction to be invalid or unconstitutional for any reason, the remainder of this Agreement and the application of such provision or part thereof to other persons or circumstances shall not be affected thereby.

SECTION 31 – ASSIGNMENT, SUBLET, AND TRANSFER

Concessionaire shall not assign, sublet, or transfer its interests or obligations under the provisions of this Agreement without the prior written consent of City, which shall not be unreasonably withheld or delayed. This Agreement shall be binding on the heirs, successors, and assigns of each party hereto. Concessionaire shall provide not less than forty-five (45) days advance written notice of any intended assignment, sublet or transfer.

SECTION 32 – NO WAIVER

The failure of any party to insist, in any one or more instance, upon performance of any of the terms, covenants, or conditions of this Agreement shall not be construed as a waiver, or relinquishment of the future performance of any such term, covenant, or condition by any other party hereto but the obligation of such other party with respect to such future performance shall continue in full force and effect.

SECTION 33 – CONFLICTS OF INTEREST

Concessionaire covenants that it presently has no interest and shall not acquire any interest, direct or indirect, which would conflict in any manner or degree with the performance of its services hereunder. Concessionaire further covenants that in the performance of this Agreement no person having any conflicting interest shall be employed. Any interest on the part of Concessionaire or its employee must be disclosed to City.

SECTION 34 – POLITICAL ACTIVITIES

Concessionaire shall not engage in any political activities while in performance of any and all services and work under this Agreement.

SECTION 35 – ENTIRE AND SUPERSEDING AGREEMENT

This writing, all Exhibits hereto, and the other documents and agreements referenced herein, constitute the entire Agreement between the parties with respect to the subject matter hereof, and all prior agreements, correspondences, discussions and understandings of the parties (whether written or oral) are merged herein and made a part hereof. This Agreement, however, shall be deemed and read to include and incorporate such minutes, approvals, plans, and specifications, as referenced in this Agreement, and in the event of a conflict between this Agreement and any action of City, granting approvals or conditions attendant with such approval, the specific action of City shall be deemed controlling.

SECTION 36 – AMENDMENT

This Agreement shall be amended only by formal written supplementary amendment. No oral amendment of this Agreement shall be given any effect. All amendments to this Agreement shall be in writing executed by both parties.

SECTION 37 – TIME COMPUTATION

Any period of time described in this Agreement by reference to a number of days includes Saturdays, Sundays, and any state or national holidays. Any period of time described in this Agreement by reference to a number of business days does not include Saturdays, Sundays or any state or national holidays. If the date or last date to perform any act or to give any notices is a Saturday, Sunday or state or national holiday, that act or notice may be timely performed or given on the next succeeding day which is not a Saturday, Sunday or state or national holiday.

SECTION 38 – NOTICES

NOTICES. Any notice, demand, certificate or other communication under this Agreement shall be given in writing and deemed effective: a) when personally delivered; b) three (3) days after deposit within the United States Postal Service, postage prepaid, certified, return receipt requested; or c) one (1) business day after deposit with a nationally recognized overnight courier service, addressed by name and to the party or person intended as follows:

To the City: Killeen - Fort Hood Regional Airport
Attn: Executive Director of Aviation
8101 S. Clear Creek Rd, Box C
Killeen, TX 76549

Copy to: Attn. City Attorney
City of Killeen
101 N. College St., 1st Floor
Killeen, TX 76541

To the Concessionaire: Avis Budget Car Rental, LLC
6 Sylvan Way
Parsippany, NJ 07054

The parties may designate other addresses from time to time in writing. Concessionaire

must provide a valid new address for notices within ten (10) days if the above address becomes invalid.

SECTION 39 – CONSTRUCTION

This Agreement shall be construed without regard to any presumption or rule requiring construction against the party causing such instrument to be drafted. This Agreement shall be deemed to have been drafted by the parties of equal bargaining strength. The captions appearing at the first of each numbered section of this Agreement are inserted and included solely for convenience but shall never be considered or given any effect in construing this Agreement with the duties, obligations, or liabilities of the respective parties hereto or in ascertaining intent, if any questions of intent should arise. All terms and words used in this Agreement, whether singular or plural and regardless of the gender thereof, shall be deemed to include any other number and any other gender as the context may require.

SECTION 40 – NO THIRD PARTY BENEFICIARY

Nothing contained in this Agreement, nor the performance of the parties hereunder, is intended to benefit, nor shall inure to the benefit of, any third party.

SECTION 41 – COMPLIANCE WITH LAW

The parties shall comply in all material respects with any and all applicable federal, state and local laws, regulations and ordinances.

SECTION 42 – FORCE MAJEURE

City shall not be responsible to Concessionaire and Concessionaire shall not be responsible to City for any resulting losses and it shall not be a default hereunder if the fulfillment of any of the terms of this Agreement is delayed or prevented by revolutions or other civil disorders, wars, acts of enemies, strikes, fires, floods, acts of God, adverse weather conditions, legally required environmental remedial actions, industry-wide shortage of materials, or by any other cause not within the control of the party whose performance was interfered with, and which exercise of reasonable diligence, such party is unable to prevent, whether of the class of causes hereinabove enumerated or not, and the time for performance shall be extended by the period of delay occasioned by any such cause.

SECTION 43 – GOOD STANDING

Concessionaire affirms that it is a company duly formed and validly existing and in good standing under the laws of the State of Texas and has the power and all necessary licenses, permits and franchises to own its assets and properties and to carry on its business. Concessionaire is duly licensed or qualified to do business and is in good standing in the State of Texas and in all other jurisdictions in which failure to do so would have a material adverse effect on its business or financial condition.

SECTION 44 – INDEPENDENT CONTRACTORS

The parties, their employees, agents, volunteers, and representative shall be deemed independent contractors of each other and shall in no way be deemed as a result of this Agreement to be employees of the other. The parties, their employees, agents, volunteers, and representatives are not entitled to any of the benefits that the other provides for its employees. The parties shall not be considered joint agents, joint venturers, or partners.

SECTION 45 – GOVERNMENTAL APPROVALS

Concessionaire acknowledges that various of the specific undertakings of City described in this Agreement may require approvals from the City of Killeen City Council, City of Killeen bodies, and/or other public bodies, some of which may require public hearings and other legal proceedings as conditions precedent thereto. Concessionaire further acknowledges that this Agreement is subject to appropriation by the Killeen City Council. City's obligation to perform under this Agreement is conditioned upon obtaining all such approvals in the manner required by law. City cannot assure that all such approvals will be obtained, however, it agrees to use good faith efforts to obtain such approvals on a timely basis.

SECTION 46 – AUTHORITY

The persons signing this Agreement warrant that they have the authority to sign as, or on behalf of, the party for whom they are signing.

SECTION 47 – COUNTERPARTS

This Agreement may be executed in one or more counterparts, all of which shall be considered but one and the same agreements and shall become effective when one or more counterparts have been signed by each of the parties and delivered to the other party.

SECTION 48 – SURVIVAL

All express representations, indemnifications and limitations of liability included in this Agreement will survive its completion or termination for any reason.

SECTION 49 – MORE FAVORABLE TERMS

In the event the City shall enter into any lease or agreement with any other rental car operator within the Airline Terminal building, that agreement will not contain more favorable terms than this Agreement, unless the same rights, privileges, and more favorable terms are concurrently made available to Concessionaire.

SECTION 50 – ENVIRONMENTAL

Subsection 50.1 Disposal, Use and Storage of Hazardous Materials. Disposal of Hazardous Materials on the Airport is strictly prohibited. Storage and use of Hazardous Materials on the Airport is prohibited, except:

- A. Concessionaire may store and use Hazardous Materials on the Leased Premises in a safe and prudent manner and in accordance with the requirements of all applicable Environmental Laws but only for those kinds and quantities of Hazardous Materials that are normally used in conducting the activities permitted under this Agreement. Storage shall be in an approved Hazardous Materials cabinet or storage container. Concessionaire shall provide Executive Director of Aviation with a copy of any application for a permit for use or storage of Hazardous Materials on the Leased Premises from any regulatory agency responsible for enforcement of Environmental Laws, and shall also a copy of any permit received from such agency; and
- B. Concessionaire may use Hazardous Materials on the Airport other than the Leased Premises only in a safe and prudent manner and in accordance with the requirements of all applicable Environmental Laws but only for those kinds and quantities of Hazardous Materials which are commonly used in conducting the activities permitted under this Agreement.

Subsection 50.2 Liability. Concessionaire shall be solely and fully responsible and liable for:

- A. Storage, use or disposal of Hazardous Materials on the Leased Premises or the Airport, by Concessionaire, Concessionaire's officers, agents, employees, or contractors,
- B. Any Hazardous Material release which is caused by or results from the activities of Concessionaire, Concessionaire's officers, agents, employees, or contractors on the Leased Premises or the Airport.

Subsection 50.3 Prevention of Release. Concessionaire shall take all necessary precautions to prevent its activities from causing any Hazardous Material release to occur on the Leased Premises or the Airport, including, but not limited to any release into soil, groundwater, or City's sewage or storm drainage system.

Subsection 50.4 Obligation to Investigate and Remediate. Concessionaire, at Concessionaire's sole cost and expense, shall promptly investigate and remediate, in accordance with requirements of all applicable Environmental Laws:

- A. Any release or threat of release of Hazardous Material on the Leased Premises or the Airport, including, but not limited to, into soil or groundwater, or City's sewage or storm drainage system which was caused or results in whole or in part from the activities of Concessionaire, Concessionaire's

officers, agents, employees, contractors, permittees or invitees; except that Concessionaire shall have no responsibility for any release or threat of release of Hazardous Material which Concessionaire establishes was caused by the sole negligence or willful misconduct of City, City's officers, agents, employees, contractors or permittees by any third party, or by migration of Hazardous Materials onto the premises from a specifically identifiable source off the use premises. In addition to all other rights and remedies of City hereunder, if Concessionaire does not promptly commence, and diligently pursue to remediate, to the extent required, any such release, or threat of release, of Hazardous Materials for which it has responsibility under this section, City, in its discretion, may pay to have same remediated and Concessionaire shall reimburse City plus a fifteen percent administration fee within fifteen (15) business days of City's demand for payment. The failure to commence investigation and provide City with a schedule for diligent completion of the remediation within thirty (30) days after discovery of such release, or threat of release, of Hazardous Material shall constitute prima facie evidence of failure to promptly commence remediation. The demand for payment by City shall be prima facie evidence that expense was incurred by City.

Subsection 50.5 Records and Inspections.

- A. Concessionaire will maintain a chemical inventory list and material safety data sheets of hazardous materials stored on site in accordance with state and federal regulations. The Concessionaire will also maintain manifests for all hazardous or regulated wastes transported and disposed of off-site.
- B. Upon reasonable notice by City, Concessionaire shall make available for review by City such records pertaining to the use, handling and disposal of any Hazardous Material(s) as Concessionaire is required to maintain under this section.
- C. City shall have the right, under the terms hereof, and upon reasonable notice for exclusive use space, to enter the Leased Premises during the Term hereof to conduct periodic environmental inspections and testing. City shall conduct each inspection or test in a manner that does not unreasonably interfere with Concessionaire's operations.

Subsection 50.6 Concessionaire Obligations upon Termination. Prior to vacating the Leased Premises, and in addition to all other requirements under this Agreement, Concessionaire shall remove any containers of Hazardous Materials placed on the Leased Premises during the Term by Concessionaire or as a result of Concessionaire's use or occupancy of the Leased Premises during the Term and shall demonstrate to City's reasonable satisfaction that such removal is in compliance with all applicable Environmental Laws, including without limitation conducting any environmental audits as may be required by City.

Subsection 50.7 Storm Water.

- A. Notwithstanding any other provisions or terms of this Agreement, Concessionaire acknowledges that certain properties within the Airport, or on City-owned land, are subject to storm water rules and regulations. Concessionaire agrees to observe and abide by such storm water rules and regulations as may be applicable to City's property and Concessionaire's uses thereof.
- B. Concessionaire acknowledges that any storm water discharge permit issued to City may name Concessionaire as a co-permittee. City and Concessionaire both acknowledge that close cooperation is necessary to insure compliance with any storm water discharge permit terms and conditions, as well as to insure safety and to minimize cost of compliance. Concessionaire acknowledges further that it may be necessary to undertake such actions to minimize the exposure of storm water to "significant materials" generated, stored, handled or otherwise used by Concessionaire, as such term may be defined by applicable storm water rules and regulations, by implementing and maintaining "best management practices" as that term may be defined in applicable storm water rules and regulations.
- C. City will provide Concessionaire with written notice of any storm water discharge permit requirements applicable to Concessionaire and with which Concessionaire will be obligated to comply from time-to-time, including, but not limited to: certification of non-storm water discharges; collection of storm water samples; preparation of storm water pollution prevention or similar plans; implementation of best management practices; and maintenance of necessary records. Such written notice shall include applicable deadlines. Concessionaire agrees that within thirty (30) days of receipt of such written notice it shall notify City in writing if it disputes any of the storm water permit requirements it is being directed to undertake. If Concessionaire does not provide such timely notice, Concessionaire will be deemed to assent to undertake such storm water permit requirements. In that event, Concessionaire agrees to undertake, at its sole expense, unless otherwise agreed to in writing between City and Concessionaire, those storm water permit requirements for which it has received written notice from City, and Concessionaire agrees that it will hold harmless and indemnify City for any violations or non-compliance with any such permit requirements.

SECTION 51 – ISRAEL CLAUSE

Concessionaire hereby verifies that it does not boycott Israel and will not boycott Israel during the term of this Agreement. Boycotting Israel is defined in Texas Government Code section 808.001 to mean refusing to deal with, terminating business activities with, or taking any action that is intended to penalize, inflict economic harm on, or limit commercial relations specifically with Israel, or with a person or entity doing business in Israel or in an Israeli-controlled territory, but does not include an action made for

ordinary business purposes.

IN WITNESS WHEREOF, the parties have executed this Agreement in duplicate on this ____ day of _____, 2018.

ATTEST:

CITY OF KILLEEN:

Lucy Aldrich
City Secretary

Ronald L. Olson
City Manager

ATTEST:

Avis Budget Car Rental, LLC

(name of signing authority)

(title)

EXHIBIT A1 - COUNTER/OFFICE/QUEUING AREAS

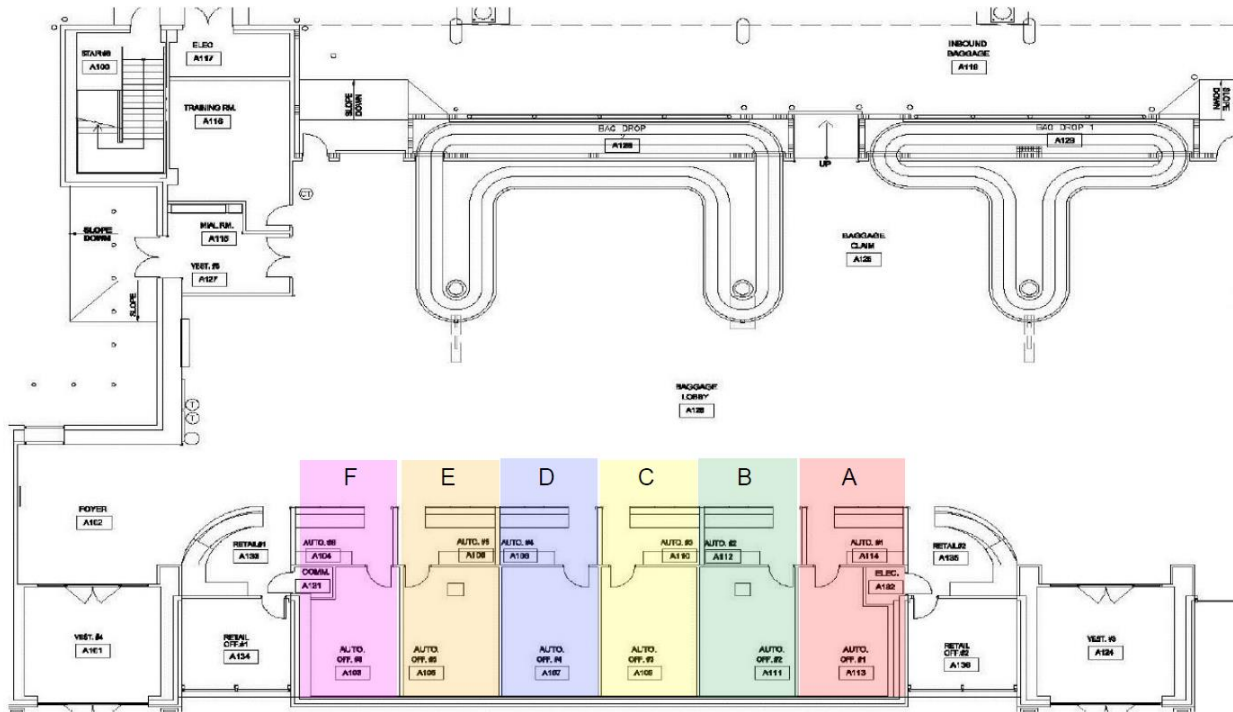

Space	Office	Counter Area	Queuing	Total Square Footage	Counter Length
A	199	107	102	408	12' 9"
B	232	109	103	444	12' 10"
C	232	109	103	444	12' 10"
D	232	109	103	444	12' 10"
E	232	109	103	444	12' 10"
F	199	104	102	405	12' 9"

REVISED EXHIBIT A2 - READY/RETURN BLOCKS AND SERVICE BAYS

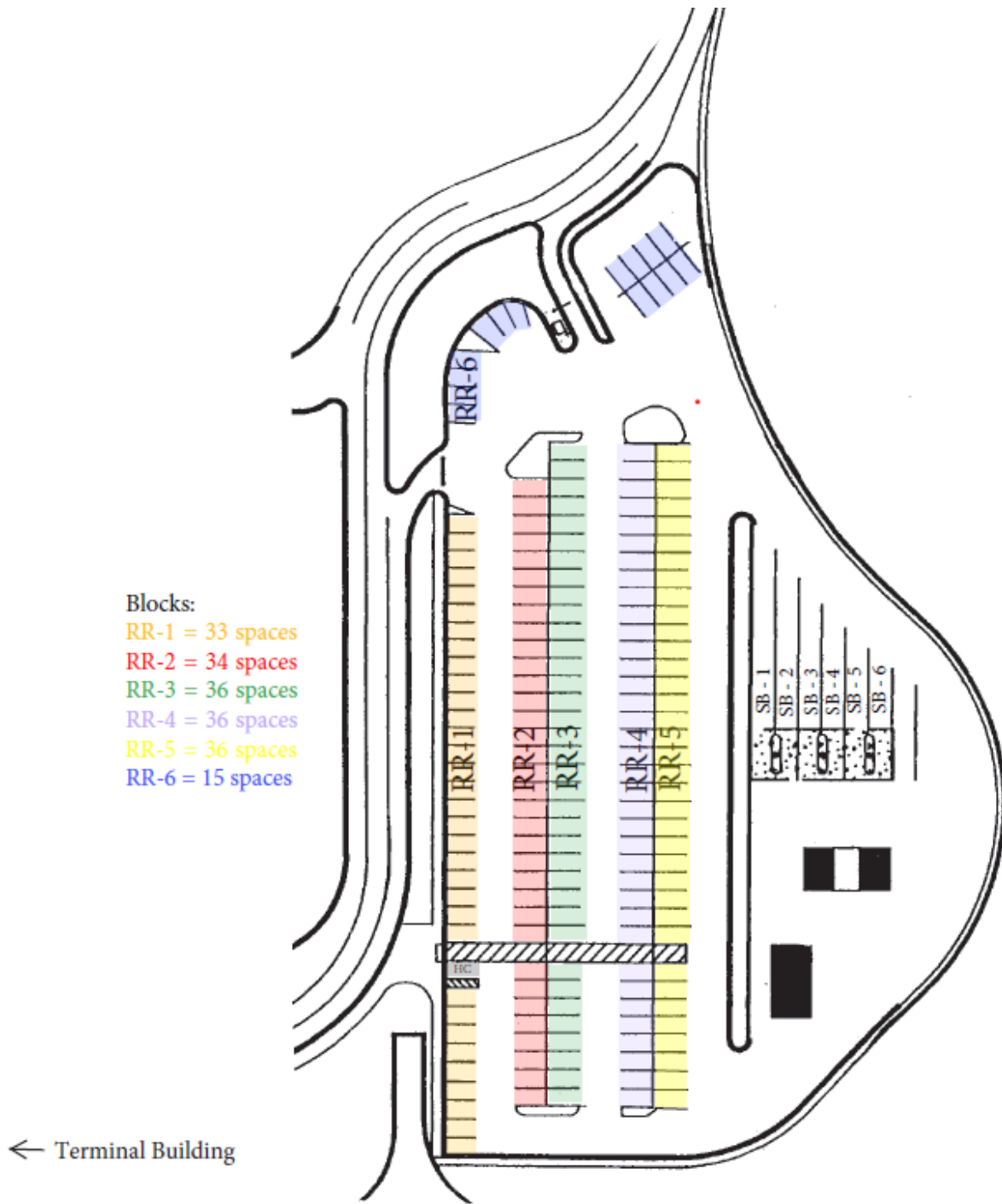

EXHIBIT A3 - STORAGE AREA

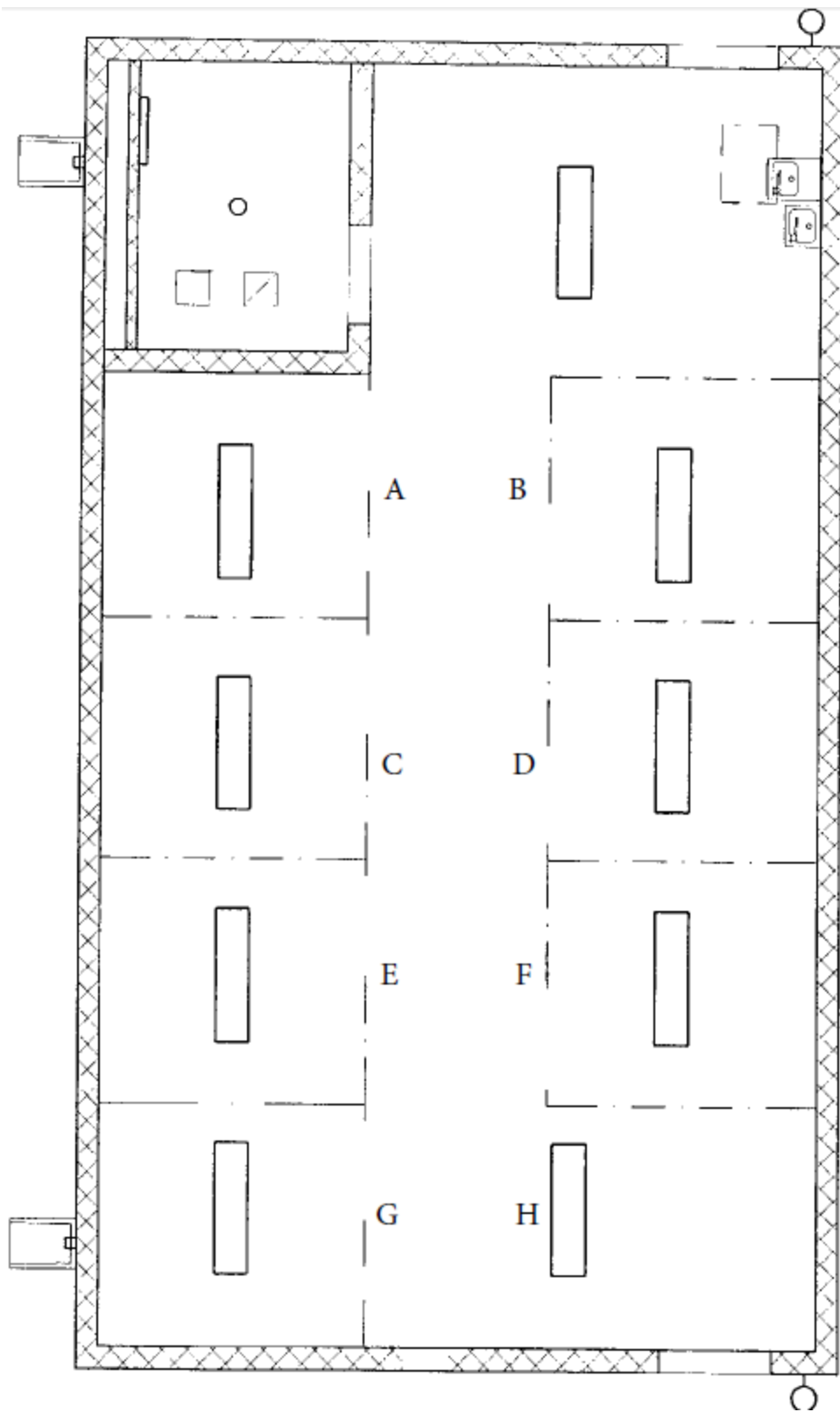

EXHIBIT A4 – OVERFLOW PARKING LANES

RENTAL CAR OVERFLOW
PARKING LOT

27 - LANES
Each lane 8'6" x 85'

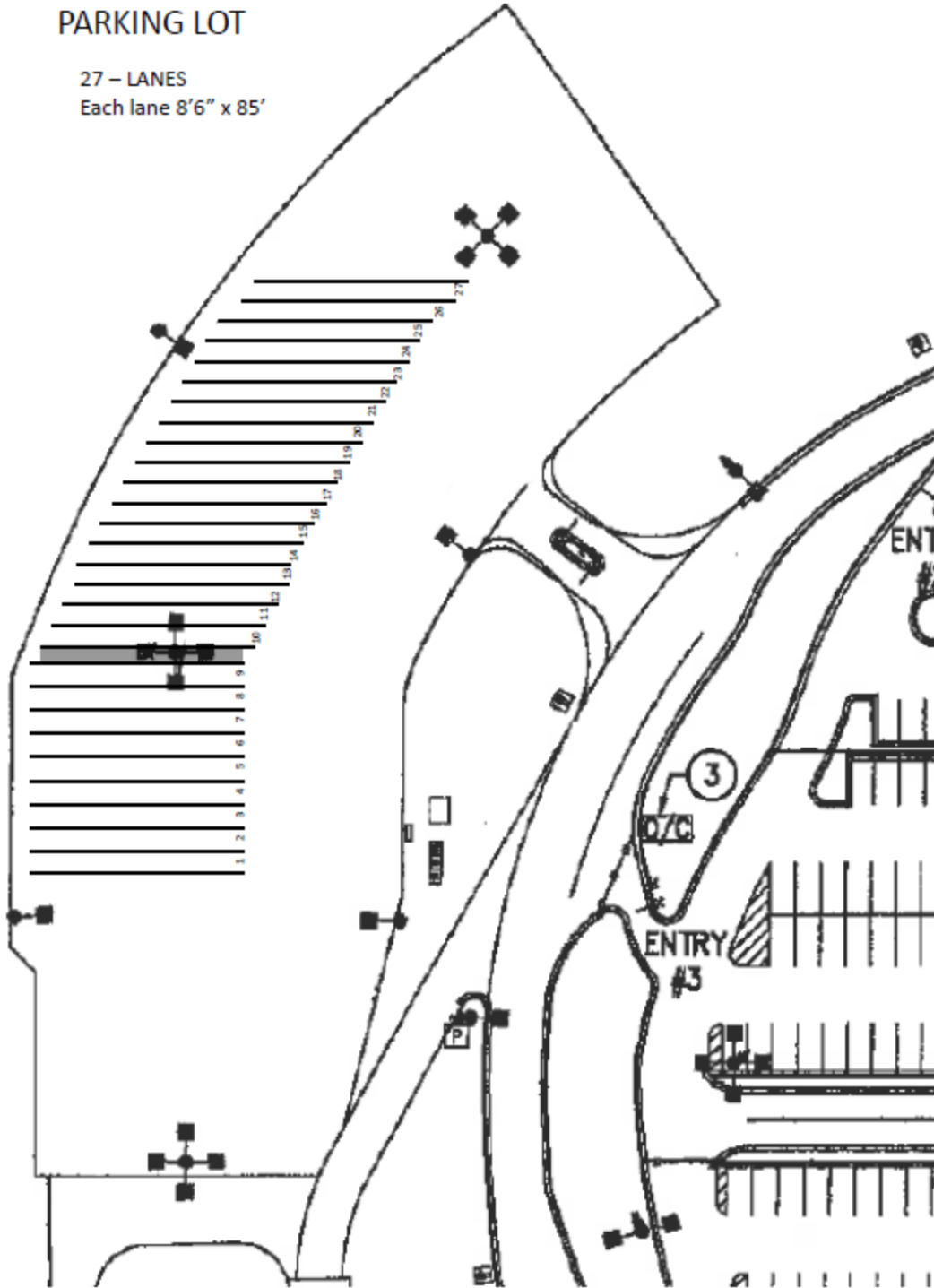

EXHIBIT B

KILLEEN – FORT HOOD REGIONAL AIRPORT
RENTAL CAR MONTHLY REPORT OF GROSS REVENUES
FOR MONTH OF _____

Concessionaire Name: _____

Address: _____

City, State, Zip: _____

Contact Name: _____

Phone # _____

GROSS RENTAL REVENUE: _____

Airport Fee (10%) _____

Less Monthly Guarantee paid 1st of month: _____

(1) Privilege Fee Balance Due: _____

Number of Transaction: _____

Number of Transaction Days: _____

(2) CFC Due (@ \$3.00 per Transaction Day): _____

Amount Due with this report (1) +(2): \$ _____

Concessionaire Official Signing and Certifying accuracy of Information on this report:

Signature _____

Typed Name & Title _____

Date signed _____

REMIT THIS FORM AND PAYMENT TO: City of Killeen Finance Department
Attn: Accounts Receivable
P.O. Box 1329
Killeen, TX 76540

CONCESSION AGREEMENT

NON-EXCLUSIVE RENTAL CAR CONCESSION
Killeen - Fort Hood Regional Airport
Killeen, Texas

between

Killeen - Fort Hood Regional Airport
City of Killeen, Texas

and

EAN Holdings, LLC d/b/a Alamo Rent A Car and National Car Rental

<u>Section</u>	<u>Page</u>
DEFINITIONS	6
SECTION 1 – LEASED PREMISES.....	9
SECTION 2 – TERM	9
SECTION 3 – USES, PRIVILEGES, COBRANDING AND OBLIGATIONS	9
SECTION 4 – RESTRICTIONS ON USES AND PRIVILEGES.....	11
SECTION 5 – PRIVILEGE FEE, RENTS, FEES AND ACCOUNTING RECORDS.....	11
Subsection 5.1 Privilege Fee, Rent and Fees.	11
Subsection 5.2 Statements, Books, and Records; Delinquent Rentals.	16
Subsection 5.3 Audit.....	17
SECTION 6 – INSTALLATION OF IMPROVEMENTS AND DESIGN, FURNISHING, AND EQUIPPING OF PREMISES	17
Subsection 6.1 Building Services	17
Subsection 6.2 Approval of Plans and Specifications; Provision of Drawings.....	17
SECTION 7 – TITLE TO IMPROVEMENTS, STRUCTURAL ALTERATIONS, ETC.	18
Subsection 7.1 Title.....	18
Subsection 7.2 Structural Alterations.....	19
Subsection 7.3 Alterations and Improvements to Airport.....	19
Subsection 7.4 Removal and Demolition.....	19
SECTION 8 – MAINTENANCE OF PREMISES	19
Subsection 8.1 Airport Maintenance Obligations.	19
Subsection 8.2 Concessionaire's Maintenance Obligations.	20
SECTION 9 – LIENS, PAYMENT, AND PERFORMANCE BONDS.....	21
Subsection 9.1 Construction Surety Bond.	21
Subsection 9.2.....	22
Subsection 9.3.....	22

SECTION 10 – OPERATION OF LEASED PREMISES: HOURS AND DELIVERIES	22
Subsection 10.1 Hours of Operation.....	22
Subsection 10.2 Delivery of Goods.	22
Subsection 10.3 Utilities.	22
 SECTION 11 – QUALITY AND CHARACTER OF SERVICE.....	23
Subsection 11.1 Type of Operation.	23
Subsection 11.2 Services to the General Public.....	23
Subsection 11.3 Additional Compliance.	23
Subsection 11.4 Personnel.....	23
 SECTION 12 – NON-DISCRIMINATION.....	24
 SECTION 13 – IDEMNIFICATION AND INSURANCE.....	24
Subsection 13.1 Indemnification.....	24
Subsection 13.2 Concessionaire to Provide General Liability and Automobile Insurance.	25
Subsection 13.3 Concessionaire to Provide Property and Fire Insurance.....	25
Subsection 13.4 Both Concessionaire and City to Carry Fire Insurance.	25
Subsection 13.5 Insurance Certificate.	26
Subsection 13.6 Concessionaire Failure to Provide Certificates.	26
 SECTION 14 – DAMAGE OR DESTRUCTION OF LEASED PREMISES	26
Subsection 14.1 Partial Damage.	26
Subsection 14.2 Extensive Damage.....	26
Subsection 14.3 Complete Destruction.	27
Subsection 14.4 Limits of City's Obligations Defined.....	27
 SECTION 15 – CANCELLATION	27
Subsection 15.1 Cancellation by Concessionaire.....	27
Subsection 15.2 Cancellation by City.	28
Subsection 15.3 Termination.	29
Subsection 15.4 Notice of Termination.....	29
 SECTION 16 – NONWAIVER OF RIGHTS	29
 SECTION 17 – SURRENDER OF POSSESSION	29
 SECTION 18 – TAXES AND LICENSES	29

SECTION 19 – INSPECTION OF PREMISES 30

SECTION 20 – HOLDING OVER 30

SECTION 21 – QUIET ENJOYMENT 30

SECTION 22 – NO LIENS..... 30

SECTION 23 – SECURITY AGREEMENTS 30

SECTION 24 – AGREEMENT SUBORDINATE TO AGREEMENTS WITH THE
UNITED STATES 30

SECTION 25 – RIGHTS AND PRIVILEGES OF CITY 31

SECTION 26 – ACCESS CONTROL 32

SECTION 27 – NO PERSONAL LIABILITY 33

SECTION 28 – GOVERNING LAW..... 33

SECTION 29 – NOTIFICATION 33

SECTION 30 – SEVERABILITY 34

SECTION 31 – ASSIGNMENT, SUBLET, AND TRANSFER 34

SECTION 32 – NO WAIVER 34

SECTION 33 – CONFLICTS OF INTEREST 34

SECTION 34 – POLITICAL ACTIVITIES..... 34

SECTION 35 – ENTIRE AND SUPERSEDING AGREEMENT 34

SECTION 36 – AMENDMENT	35
SECTION 37 – TIME COMPUTATION	35
SECTION 38 – NOTICES	35
SECTION 39 – CONSTRUCTION.....	36
SECTION 40 – NO THIRD PARTY BENEFICIARY	36
SECTION 41 – COMPLIANCE WITH LAW	36
SECTION 42 – FORCE MAJEURE.....	36
SECTION 43 – GOOD STANDING.....	36
SECTION 44 – INDEPENDENT CONTRACTORS	37
SECTION 45 – GOVERNMENTAL APPROVALS.....	37
SECTION 46 – AUTHORITY.....	37
SECTION 47 – COUNTERPARTS.....	37
SECTION 48 – SURVIVAL.....	37
SECTION 49 – MORE FAVORABLE TERMS.....	37
SECTION 50 – ENVIRONMENTAL.....	38
SECTION 51 – ISRAEL CLAUSE	40
EXHIBIT A1 - COUNTER/OFFICE/QUEUING AREAS	42
EXHIBIT A2 - READY/RETURN BLOCKS AND SERVICE BAYS	43

EXHIBIT A3 – STORAGE AREA..... 43

EXHIBIT A4 – OVERFLOW PARKING LANES..... 44

EXHIBIT B..... 45

RENTAL CAR CONCESSION
Killeen - Fort Hood Regional Airport
Killeen, Texas

THIS CONCESSION AGREEMENT ("**Agreement**"), made and entered into this 1st day of January, 2019, by and between the City of Killeen (the "**City**"), a municipal corporation and existing under the laws of the State of Texas, whose address is 8101 S. Clear Creek Rd, Box C, Killeen, Texas 76549, hereinafter referred to as "City" and EAN Holdings, LLC operating as Alamo Rent A Car and National Car Rental, (hereinafter referred to as "**Concessionaire**"), a limited liability company with its office and address being 4210 South Congress Avenue, Austin TX 78745, with a mailing address of 4210 South Congress Avenue, Austin TX 78745.

WITNESSETH:

WHEREAS, City controls, owns, operates, and maintains an airport in the City of Killeen, County of Bell, State of Texas, known as Killeen - Fort Hood Regional Airport (hereinafter referred to as "Airport"), and has the power to grant rights and privileges with respect thereto, and

WHEREAS, the City has determined it to be in the best interests of the public and the City to enter into this Agreement with Concessionaire to provide rental car concession services at the Airport pursuant and subject to the terms and conditions hereunder,

NOW, THEREFORE, THE PARTIES AGREE:

DEFINITIONS

The following terms and phrases shall have the following meanings for purposes of this Agreement:

1. "ACDBE" shall mean airport concession disadvantaged business enterprise as that term is defined by 49 CFR Part 23.
2. "City" shall mean the municipal corporation existing under the laws of the State of Texas which controls, operates, and maintains the Killeen - Fort Hood Regional Airport.
3. "Environmental Law" shall mean any federal, state or local law, rule, regulation, order or requirement relating to protection of human health and safety or the environment.
4. "Executive Director of Aviation" shall mean the Executive Director of Aviation of the City's Airport, or his or her designee.
5. "Gross Revenues" as used herein shall mean, as determined in the reasonable discretion of the City, all amounts charged to its customers by Concessionaire for or

in connection with agreements it secures through its operations and business at the Airport, regardless of whether such amount is actually paid to or received by Concessionaire. Gross Revenues shall include all monies or other consideration of whatsoever nature paid or payable to Concessionaire by customers for all sales made and services performed for cash, credit or consideration in connection with automobile and vehicle rentals or other products or services provided to persons through Concessionaire's operations at the Airport, without regard to the ownership, area, fleet, or location assignment of vehicles and without regard to the manner in which or place at which the vehicles or other products or services are furnished to Concessionaire's customers and without regard to whether the vehicles or other products are returned to the Airport or to some other location.

Gross Revenues shall include anything and everything that is not specifically excluded. The only exclusions from Gross Revenues permitted under this Agreement shall be the specific exclusions set forth below:

- Federal, state, county, city or municipal sales, use, or excise taxes now in effect or hereinafter levied on Concessionaire's operations which are separately stated on customers' rental contracts and collected from customers of Concessionaire;
 - Those fees referred to in this Agreement as Customer Facility Charges, "CFCs" which for the purpose of this Agreement shall include all customer facility charges, authorized pursuant to City Resolution, as may be amended;
 - Amounts received specifically for the actual loss of or damages of vehicles or other property of Concessionaire;
 - Amounts received from the sale of vehicles off-Airport premises; provided, however, any amounts paid in connection with automobile and vehicle rentals or other products or services provided to persons through Concessionaire's operations that are applied to or otherwise reimbursed as a result of the sale of a vehicle shall not be excluded from Gross Revenues; and
 - Reimbursements for amounts actually paid for speeding tickets, parking tickets, red light tickets, tolls and toll violations, and towing and impound fees from its customers to pass through without markup to an independent third party with no amount being retained by Concessionaire. However, any amounts collected above the pass through amount shall be included as Gross Revenue under this Agreement.
6. "Hazardous Material" shall mean any material that, because of its quantity, concentration or physical or chemical characteristics, is deemed by any federal, state or local governmental authority to pose a present or potential hazard to human health or safety or to the environment, and includes any material or substance

identified, listed, or defined as a "hazardous waste" "hazardous substance," or "pollutant" or "contaminant" or term of similar import, or is otherwise regulated pursuant to Environmental Laws, including any asbestos and asbestos-containing materials; petroleum, including crude oil or any fraction thereof, natural gas or natural gas liquids.

7. "Leasehold Improvements" shall mean all improvements and equipment which are affixed to the Leased Premises and which cannot be removed without material damage to the Premises.
8. "Operations Year" shall mean January 1 through December 31 annually.
9. "Personal Property" shall mean all movable property of the Concessionaire not directly related to the rental car operations of the privileges granted hereunder, including, office furniture, office equipment, and office supplies.
10. "Refurbish" or "Refurbishment" shall mean the routine repainting or redecoration of public areas within the Leased Premises, as necessary, including the replacement or repair of worn carpet, tile, furniture, or furnishings.
11. "Rental Car" or "Motor Vehicles" shall mean motor vehicles designed primarily for the carriage of passengers and commonly classified as sedans, coupes, convertibles, station wagons, four-wheel drive vehicles, passenger vans, sport utility vehicles, and pick-up trucks rated one-ton or less. Concessionaire shall not park, store, or rent from Premises any vehicles except Motor Vehicles as defined herein that it owns or rents and are properly available for rental as provided herein.
12. "Terminal Building" shall mean the terminal building at the Airport.
13. "Trade Fixtures" shall mean all non-affixed items, except expendables and Personal Property, which can be removed without damage to the Leased Premises, including cash registers, safes, patron tables and chairs, display fixtures, and the like.
14. "Transaction" shall mean the execution of an agreement or contract for the rental of a Motor Vehicle; or, the payment of funds or completion of a cash or credit transaction for payment for rental of a Motor Vehicle; or delivery of a Motor Vehicle to a customer for use in exchange for cash, credit or any other consideration.
15. "Transaction Day" shall mean each twenty-four (24) hour period or portion thereof, for which a customer of a Rental Car concessionaire rents, or otherwise enters into a similar arrangement for the use of a Motor Vehicle and for which the Rental Car concessionaire collects revenue from the customer. Late returns (after twenty four (24) hours) shall be considered a Transaction Day.

SECTION 1 – LEASED PREMISES

- A. City hereby leases to Concessionaire and Concessionaire hereby agrees to lease from City the following premises, which, collectively, are hereinafter called the "Leased Premises": Four Hundred and Forty Four (444) square feet of counter/office/queuing area "E" in the terminal building, Block "RR-4" the ready return area containing approximately thirty-six (36) ready/return parking spaces outside and adjacent to the terminal building, and Service Bay "4". Said Leased Premises is more particularly shown on **Exhibits A1, A2, and A3** attached hereto and by this reference made a part hereof.
- B. Concessionaire agrees that its Leased Premises have been inspected by Concessionaire and are accepted and will be occupied by Concessionaire on an "as is" basis. The Concessionaire specifically waives any covenants or warranties regarding the Premises, including but not limited to any warranty of suitability and warranty of fitness.

SECTION 2 – TERM

The term of this Agreement is for a five (5) year period commencing on January 1, 2019 and terminating on December 31, 2023 unless sooner terminated or canceled as hereinafter provided.

SECTION 3 – USES, PRIVILEGES, COBRANDING AND OBLIGATIONS

Concessionaire shall have the following uses, privileges, and obligations in connection with its use of the Leased Premises:

- A. The non-exclusive right, privilege, and obligation to conduct and operate a rental car, van or truck rental concession at the Airport. Co-Branding by Concessionaire is limited to two brands per concession space specifically those listed in their submitted proposal. It being understood that no more than two brands under rental car agencies which are owned by the same parent company may operate from any one concession space during the term of this agreement. Concessionaire understands and agrees that it shall not engage in any other business on the Airport under this Agreement.
- B. The right, privilege, and obligation to rent and check-in rental vehicles, including the right to offer for sale related collision damage waiver protection, personal injury and accident insurance, personal effects insurance, and such other travel or vehicle related coverage offered in connection with and incidental to the rental of a vehicle and occupy operations office, storage, and Ready and Return car parking spaces. It is the intent of this Agreement that rental car customers of Concessionaire will operate the vehicle rented only from the ready spaces provided herein, and Concessionaire shall not engage in customer shuttle operations of any kind to, from, or on the Airport. This does not prohibit the picking up of a customer from the Fixed Base Operator (FBO). No trucks larger

than ¾ ton pickup type/style will be allowed in the ready lot unless approved in writing in advance by the Executive Director of Aviation.

- C. The non-exclusive right and privilege to wash vehicles rented by Concessionaire under the provisions of this Agreement in the City's car wash.
- D. The right and privilege to service vehicles rented by the Concessionaire under the provisions of this Agreement in the service bay identified in Section 1. Concessionaire shall use the service bay for the following activities only: vehicle automated and hand washing, cleaning, fluid replacement, vacuuming, and related activities as are necessary for preparing its vehicles for rental. No washing or vehicle maintenance may be conducted in the rental car parking lot or overflow parking areas.
- E. The right of ingress and egress to and from the Premises, over Airport roadways, is subject to such reasonable rules and regulations as may be established by Airport as respecting such use and subject to law.
- F. Concessionaire shall install no signs on or about the Premises without the prior written approval of the Executive Director of Aviation, said approval being solely discretionary with the Executive Director of Aviation. For purposes of this Section, signs shall include, but not necessarily be limited to, identification signs, company logos, advertising or promotions, photographs, art displays, and the like. Such signs shall be substantially uniform in size, types and location with those of other concessionaries, and subject to Executive Director of Aviation's approval, Rules and Regulations, and in compliance with all applicable laws and resolutions. No temporary signs or displays shall be permitted on the backwall or the counter surfaces without the prior written approval of the Executive Director of Aviation. Handwritten, or hand lettered signs are prohibited. Concessionaire shall not place or install any racks, stands, trade fixtures, pedestal signs, or other displays of products outside the boundaries of the Leased Premises without the express prior written approval of the Executive Director of Aviation.
- G. The right for Concessionaire's employees, in common with other employees of tenants of the Terminal Building, to use vehicular parking space provided by City, subject to the payment of reasonable charges therefore, as set by the City.
- H. *Airport Concession Disadvantaged Business Enterprise Program*
 - 1. This agreement is subject to the requirements of the U.S. Department of Transportation's regulations, 49 CFR Parts 23 and 26 related to the airport concession disadvantaged business enterprises (ACDBE) program. The concessionaire or contractor agrees that it will not discriminate against any business owner because of the owner's race, color, national origin, or sex in connection with the award or performance of any concession agreement, management contract, or subcontract, purchase or lease

agreement, or other agreement covered by 49 CFR Part 23.

2. The concessionaire or contractor agrees to include the above statements in any subsequent concession agreement or contract covered by 49 CFR Part 23, that it enters and cause those businesses to similarly include the statements in further agreements.
3. Each year Concessionaire no later than (90) days following end of each Operational Year shall provide to City the following annual ACDBE information: the name and address of each certified ACDBE with which it has done business during the past year, a description of the nature of the services performed by and/or items purchased from each firm named, and the dollar value of each transaction.

SECTION 4 – RESTRICTIONS ON USES AND PRIVILEGES

The Leased Premises shall be used only for the purposes specified in this Agreement. Concessionaire understands and agrees that City has the right to grant up to five additional privileges under separate agreements for in-terminal rental car operations to other companies.

Prohibited Activities at the service bay include:

- A. Concessionaire shall not utilize the service bay for vehicle storage other than vehicles for rent in the process of being serviced.
- B. Concessionaire shall not utilize the service bay for any maintenance or for the storage of damaged vehicles.
- C. Concessionaire shall not allow its customers or the general public to enter the service bay.
- D. Concessionaire shall not permit its employees to vacuum, wash or fuel their personal vehicles or vehicles not part of the Concessionaire's fleet at the service bay or fueling area.

SECTION 5 – PRIVILEGE FEE, RENTS, FEES AND ACCOUNTING RECORDS

Subsection 5.1 Privilege Fee, Rent and Fees.

- A. *Privilege Fee.* As consideration for the privilege of operating the concession hereunder, Concessionaire shall pay to City each contract year, for the full term of this Agreement, a Privilege Fee. Said Privilege Fee shall be the greater of either the guaranteed Minimum Annual Privilege Fee or the Percentage Fee applicable to Gross Revenue, hereinafter defined, as follows:

1. Privilege Fee – the greater of either:
 - a. ten percent (10%) of the Concessionaire’s annual Gross Revenues (“Percentage Privilege Fee”);

OR

- b. the respective yearly amount shown below as the Concessionaire’s Minimum Annual Guaranteed fee (“MAG”):

January 1, 2019 to December 31, 2019	\$	87,689.00
January 1, 2020 to December 31, 2020	\$	87,689.00
January 1, 2021 to December 31, 2021	\$	87,689.00
January 1, 2022 to December 31, 2022	\$	87,689.00
January 1, 2023 to December 31, 2023	\$	87,689.00

2. Monthly payment shall be the greater of 1/12th of the respective year’s MAG or 10% of reported gross revenues for the previous month. The MAG payment shall be paid in advance on the first (1st) day of each month during each Operations Year, until such time as the Concessionaire has paid to the Airport an amount equal to the respective annual MAG identified in Section 5.1(A)(1)(b) above. On or before the 20th of each month the Concessionaire shall provide the Airport with: i) a signed and certified Report of Gross Revenues for the preceding month and ii) payment of any percentage Privilege Fee shown to be due for the preceding month, as designated on Exhibit B, attached hereto and made a part hereof. Once the sum of Privilege Fee payments remitted has reached the MAG in any given Operations Year, the Concessionaire may cease remittance of the 1/12th of the respective year’s MAG on the first (1st) day of each month for the remainder of that Operations Year. The Concessionaire shall continue to report and remit each and every month after the annual MAG has been reached the full 10% of reported gross revenues for the previous month.
3. In the event of a major traffic reduction at GRK, during the term of this Agreement, the MAG hereinabove provided for in this Section 5.1(A) above shall be abated for the period of time the condition exists. A major traffic reduction at GRK shall be defined as a twenty five percent (25%) reduction in the number of passengers deplaning on scheduled airline flights at GRK during any period of three (3) consecutive calendar months as compared to the number of such deplaning passengers in the same calendar months during the preceding calendar year.
4. Concessionaire acknowledges that Privilege Fee payments by Concessionaire to City under this Agreement are for Concessionaire’s privilege to use the Airport facilities and access the Airport market and are not fees imposed by City upon Concessionaire’s customers. City does not require, but will not prohibit, a separate statement of and charge for the Privilege Fee on customer invoices or rental agreements (“Recovery

Fee”), provided that such Recovery Fee meets all of the following conditions: (a) such Recovery Fee must be titled “Concession Recovery Fee,” “Concession Recoupment Fee” or such other name first approved by the Executive Director of Aviation in writing; (b) the Recovery Fee must be shown on the customer rental car agreement and invoiced with other Concessionaire charges (i.e. “above the line”); (c) the Recovery Fee as stated on the invoice and charged to the customer shall be no more than 11.11% of Gross Revenues and shall be specifically included in the Definition of Gross Revenues for purposes of remittance to City; (d) Concessionaire shall neither identify, treat, or refer to the Recovery Fee as a tax, nor imply that City is requiring the pass through of such fee; (e) Concessionaire shall comply with all applicable laws, including Federal Trade Commission requirements, any Texas Consumer Protection legislation and any commitment to or contractual obligation by Concessionaire with any governmental agency or officer with authority over Concessionaire’s activities.

B. Rent -

1. Rent for Premises

Concessionaire shall pay to the City, in advance, on the 1st day of each month, one twelfth the following annual rents or the monthly rent as applicable:

- a) For the period commencing January 1, 2019 through December 31, 2019, Concessionaire shall pay the sum of Twenty-five Dollars and Thirty-two Cents (\$25.32) per square foot per annum for Four Hundred and Forty Four (444) square feet of counter/office/queuing position in the Terminal Building. On January 1 of each year for the period of this Agreement, commencing January 1, 2020, the rental amounts for the counter/office/queuing space, shall be adjusted in accordance with the Consumer Price Index – National Index for All Urban Consumers for the previous calendar year. Said adjustment shall be computed as follows:

$$\begin{aligned} &\text{Most recent year's rate x} \\ &\quad (\text{CPI for November of most recent year} / \\ &\quad \text{CPI for November of the next most recent year}) = \text{New Rate} \end{aligned}$$

- b) For the period commencing January 1, 2019 through December 31, 2019, Concessionaire shall pay the sum of Twenty-five Thousand Nine Hundred and Twenty Dollars (\$25,920), per annum for Ready Return Block RR-4 as shown on Exhibit A2. On January 1 of each year for the period of this Agreement, commencing January 1, 2020, the rental amounts for the parking block, shall be adjusted in accordance with the Consumer Price Index – National Index for All

Urban Consumers for the previous calendar year, as described above.

- c) For the period commencing January 1, 2019 through December 31, 2019, Concessionaire shall pay the sum of Four Thousand Eight Hundred Dollars (\$4,800), per annum for service bay “5” as shown on Exhibit A2. On January 1 of each year for the period of this Agreement, commencing January 1, 2020, the rental amounts for the service bay, shall be adjusted in accordance with the Consumer Price Index – National Index for All Urban Consumers for the previous calendar year, as described above.
- d) For the period commencing January 1, 2019 through December 31, 2023, Concessionaire declined lease of a storage area as shown on Exhibit A3.
- e) If requested by Concessionaire, overflow parking lanes as agreed upon with the Executive Director of Aviation on a month to month basis in the amount of \$150 per lane per month through December 31, 2019. On January 1 of each year for the period of this Agreement, commencing January 1, 2020, the rental amounts for the overflow parking lanes, shall be adjusted in accordance with the Consumer Price Index – National Index for All Urban Consumers for the previous calendar year, as described above. Overflow lanes are shown on Exhibit A4.

C. Additional Fees –

- 1. The Concessionaire shall collect the CFCs on behalf of the Airport and remit to the Airport, in accordance with the City’s CFC resolution, the full amount of the Transaction Day fee collected from each Rental Car customer.
- 2. The Concessionaire shall pay to the City for telephone system/service access to the Internet via a T-1 as follows:

Local service	\$23.50 per line per month
Voice mail	\$4.25 per line per month
Phone rental	\$6.00 per phone per month
Maintenance fee	\$15.50 per line per month

Above telecommunication fees are subject to change as determined by the City. Payment shall be due within thirty (30) days of invoice date.

- 3. The Concessionaire shall pay to the City a per wash fee of \$2.00 per automated wash. The Concessionaire shall pay to the City, for use of the manual car wash, a rate of \$1.25 per 5 minute session.

Car wash fees are subject to change as determined by the City with advance written notice. Payment shall be due within thirty (30) days of invoice date.

4. The Concessionaire shall pay to the City, based on actual gallons of fuel pumped, a per gallon fuel rate equal to the City's purchase price of the fuel plus \$0.15 cents, as may be adjusted by the City with advance written notice.

Payment shall be due within thirty (30) days of invoice date.

5. If the Concessionaire's bid reflected the operation of two brands in its concession, Concessionaire shall pay to the City a fee of One Thousand Dollars (\$1,000) per month which shall be paid in advance on the first (1st) of each month.
6. Additional fees may include charges for special items or activities including, but not limited to, employee parking, monthly electronic access card fees, badging fees, and disposal of debris left in service bay area and assigned parking areas. The City may assess reasonable, non-discriminatory and cost-recovery based charges for these special items or activities. All new charges will be reviewed with Concessionaire prior to implementation. Other charges payable by Concessionaire shall be paid by Concessionaire to City no later than thirty (30) days following receipt by Concessionaire of billing therefor.
7. Concessionaire shall be charged, at the current short term parking rate, for any of its vehicles found to be parked in a parking space not specifically leased by the Concessionaire or without the approval of the Executive Director of Aviation.

- D. Any and all payments due to the City by Concessionaire shall be remitted to the following address:

City of Killeen Finance Department
Attn: Accounts Receivable
P.O. Box 1329
Killeen, TX 76540

- E. Year End Adjustments to Privilege Fees, Rents and Fees.

In the event the amount of payments made during the preceding Operations Year exceeds the total of any payments due for such Operations Year, the excess payment shall be credited against the payments for the next Operations Year, except that any excess payment during the final Operations Year of this Agreement will be returned to the Concessionaire within thirty (30) days after the

Airport's acceptance of the final Certified Statement described in this Section. Concessionaire shall submit separate system generated reports for each brand name operated.

Subsection 5.2 Statements, Books, and Records; Delinquent Rentals.

- A. Monthly Statements; Books and Records. Within twenty (20) days after the close of each calendar month of the term of this Agreement, Concessionaire shall submit to City, in such detail and on the statement form designated as Exhibit B or as may reasonably be specified by City, certain information, including but not limited to, the number of Transactions executed during the preceding month, the number of Transaction Days Motor Vehicles were rented during the preceding month, and the statement of its Gross Revenues during the preceding month upon which the percentage payments to City set forth in Subsection 5.1 A(1) are to be computed, and said Exhibit B statement to be signed by a responsible accounting officer of Concessionaire. City reserves the right to change the form of the monthly statement and to require the submission by Concessionaire of other information pertaining to the Gross Revenues hereunder, and Concessionaire agrees to change the form of its statements to that requested by City and to provide any such additional information City may reasonably request. Concessionaire shall keep full and accurate books and records showing all of its Gross Revenues hereunder, and City shall have the right, through its representatives and at reasonable times, at its own expense, to inspect, examine, copy, and audit such books and records, including State of Texas sales tax return records. Concessionaire hereby agrees that all such books and records will be made available to City for at least three (3) years following the period covered by such books and records.
- B. Annual Certified Statements. Each year during the term of this Agreement, Concessionaire shall provide to City a written statement, certified by an independent Certified Public Accountant, to City stating that in his or her opinion the Percentage Fees paid by Concessionaire to City during the preceding year pursuant to this Agreement were made in accordance with the terms of this Agreement. Said statement shall be submitted by Concessionaire, to be received by City within ninety (90) days of the end of each contract year. Such statement shall also contain a list of the Gross Revenues, by month, as shown on the books and records of Concessionaire and which were used to compute the Percentage Fee payments made to City during the period covered by said statement.
- C. Delinquent Rentals and Fees. Without waiving any other right or action available to City in the event of default in the payment of charges or fees payable to City, pursuant to this Agreement, a late fee of one and a half percent (1.5%) of the total amount due will be assessed to the Concessionaire if payments prescribed above are not received by the dates prescribed therein. An additional one and a half percent (1.5%) of the outstanding amount will be assessed each month that all or a portion of the Concessionaire's obligations remain unpaid.

Subsection 5.3 Audit. City reserves the right to audit Concessionaire's books and records pertaining to the Leased Premises, at its own expense, at any time for the purpose of verifying the Gross Revenues, Privilege Fee and CFC calculation hereunder for any period three (3) years prior to such audit. If, however, as a result of such audit, it is established that Concessionaire has understated the Gross Revenues received from all operations at the Leased Premises by two percent (2%) or more (after the deductions and exclusions herein), the entire expense of said audit shall be borne by Concessionaire. Any additional Privilege Fee due shall forthwith be paid by Concessionaire to City with interest thereon at one and one-half percent (1.5%) per month from the date such additional Privilege Fee became due.

SECTION 6 – INSTALLATION OF IMPROVEMENTS AND DESIGN, FURNISHING, AND EQUIPPING OF PREMISES

Subsection 6.1 Building Services

- A. City Improvements and Services. City shall initially insure and provide occupancy of the Leased Premises to Concessionaire with said Leased Premises meeting all federal, state and local code requirements for the operation of a rental car concession. City shall provide and maintain water, sewer, general lighting, electrical power, heating and air-conditioning, and telephone system/service access to the Internet via a T-1 for the Terminal Building. Heating and air conditioning, electrical service, and telephone system/service access to the Internet via T-1 are provided to the Leased Premises only. If Concessionaire requires additional lighting, electrical power, water, or adjustments to the air-conditioning system or telephone system, such additional improvements or services shall be subject to the prior written approval of Executive Director of Aviation, and any such approved improvements or services shall be made at Concessionaire's expense.
- B. Concessionaire's Right to Additional Services. Concessionaire shall have the right, at its own expense, to request and receive additional services or systems, provided that any such services or systems shall require the written approval of Executive Director of Aviation before installation.

Subsection 6.2 Approval of Plans and Specifications; Provision of Drawings.

- A. General. Any improvements to be made to or upon the Leased Premises by Concessionaire, and any subsequent alterations or additions to such improvements, shall be subject to the prior written approval of Executive Director of Aviation. Full and complete plans and specifications for all work, facilities, improvements, and finishes, and the time required to complete same, shall be submitted to and receive the written approval of Executive Director of Aviation before any work or construction is commenced, which shall not be unreasonably withheld or delayed. First-class standards of design and construction shall be complied with in connection with all such

work, facilities, and improvements; and all construction shall conform to the general architectural requirements of Executive Director of Aviation as established for each improvement program. Two (2) copies of plans for all improvements or subsequent changes therein or alterations thereof shall be given to Executive Director of Aviation for review prior to commencement of construction; after final approval by Executive Director of Aviation, Executive Director of Aviation shall return to Concessionaire one (1) approved copy for Concessionaire's records and shall retain one (1) approved copy as an official record thereof.

- B. Improvements Conform to Statutes, Ordinances, Etc. All improvements, furniture, fixtures, equipment, and finishes, including the plans and specifications therefore, constructed or installed by Concessionaire, its agents, or contractors, shall conform in all respects to applicable statutes, ordinances, building codes, and rules and regulations, and public bidding laws. Any approval given by City shall not constitute a representation or warranty as to such conformity; responsibility therefore shall at all times remain with Concessionaire.
- C. Approvals Extend to Architectural and Aesthetic Matters. Approval of City shall extend to and include architectural and aesthetic matters and City reserves the right to reasonably reject any layout or design proposals submitted and to require Concessionaire to resubmit any such layout or design proposals until they meet Executive Director of Aviation approval.
- D. Disapprovals. In the event of disapproval by City of any portion of any plans or specifications, Concessionaire shall promptly submit necessary modifications and revisions thereof for approval by Executive Director of Aviation. City agrees to act promptly upon such plans and specifications and upon requests for approval of changes or alterations in said plans or specifications. No substantial changes or alterations shall be made in said plans or specifications after initial approval by City, and no alterations or improvements shall be made to or upon the Leased Premises without the prior written approval of Executive Director of Aviation.
- E. Provision of As-Built Drawings. Upon completion of any construction project, Concessionaire shall provide City two (2) completed sets of as-built drawings in reproducible form as specified by City. Concessionaire agrees that, upon the request of City, Concessionaire will inspect the Leased Premises jointly with City to verify the as-built drawings.

SECTION 7 – TITLE TO IMPROVEMENTS, STRUCTURAL ALTERATIONS, ETC.

Subsection 7.1 Title. All improvements made to the Leased Premises by Concessionaire, and any additions and alterations thereto made by Concessionaire, shall be and remain the property of Concessionaire until the termination of this Agreement (whether by expiration of the term, cancellation, forfeiture or otherwise), at

which time said improvements, except for Trade Fixtures, personal property, and expendables, shall become the property of City, at no cost to City.

Subsection 7.2 Structural Alterations. Concessionaire shall make no structural alterations to the Leased Premises without the prior written consent of Executive Director of Aviation.

Subsection 7.3 Alterations and Improvements to Airport. Concessionaire acknowledges that from time to time City may undertake construction, repair, or other activities related to the operation, maintenance and repair of the Terminal Building which may temporarily affect Concessionaire's operations hereunder. Concessionaire agrees to accommodate City in such matters, even though Concessionaire's own activities may be inconvenienced, and Concessionaire agrees that no liability shall attach to City, its members, employees, or agents by reason of such inconvenience or impairment. It is agreed that in the event such activities of City substantially impair the operations of Concessionaire under this Agreement, the Minimum Privilege Fee shall be waived during such period of substantial impairment, with what constitutes "substantial impairment" being reasonably determined by Executive Director of Aviation after consultation with Concessionaire. Concessionaire agrees that if relocation is required that Concessionaire shall move its operations as reasonably directed by Executive Director of Aviation.

Subsection 7.4 Removal and Demolition. Concessionaire shall not remove or demolish, in whole or in part, any Leasehold Improvements upon the Leased Premises without the prior written consent of City which may, at its sole discretion, condition such consent upon the obligation of Concessionaire, at Concessionaire's cost, to replace the same by an improvement specified in such consent.

SECTION 8 – MAINTENANCE OF PREMISES

Subsection 8.1 Airport Maintenance Obligations.

- A. General Maintenance and Operation. City agrees that it will, with reasonable diligence, maintain, operate, and keep in good repair the Airport, including the Terminal Building and all appurtenances, facilities, and services now or hereafter connected therewith. Airport shall keep the car rental parking lot and the overflow parking area in suitable repair, and provide general lighting for these areas.
- B. Structural Maintenance. City shall provide, or cause to be provided, structural maintenance of the Terminal Building.
- C. Maintain Access. City shall, throughout the term of this Agreement, maintain all airport-owned roads on the Airport giving access to the Terminal Building in good and adequate condition for use by cars and trucks and shall maintain free and uninterrupted access to the Terminal Building over said road at all times. City reserves the right to reasonably restrict access to the Terminal

Building area for automobile deliveries during peak activity periods.

- D. Car Wash. City will maintain and inspect the car wash facilities as recommended by the manufacturer including routine maintenance of the car wash for normal activities, wear and tear. Normal and routine maintenance of roofs, walls, utility infrastructure, building mechanical systems and structural building components will be performed by City. Wash soaps, rinses, brushes, hoses, and utilities will be provided by the City. City has the exclusive authority to stop the use of the car wash for maintenance and inspections as is necessary, at City's sole discretion, without damage or liability to Concessionaire. City will take reasonable action to notify Concessionaire for closure of the car wash.
- E. Telephone System/Service Access to the Internet via a T-1. The Airport shall furnish telephone system/service access to the Internet via a T-1. Rates for these services will be in accordance with Section 5.1(C). A letter of agreement or other suitable document will be executed between the Airport's Executive Director of Aviation or his/her designated representative and the local designated representative of the Concessionaire to document exactly which services are agreed to between the two parties. Airport reserves the right to change or terminate said telephone and/or internet service at some point during the term of this Agreement. Airport will provide at least a ninety (90) day notice to Concessionaire of any service changes and assist in facilitating replacement services via a local communication provider.

Subsection 8.2 Concessionaire's Maintenance Obligations.

- A. Concessionaire's General Obligations. Except for maintenance of the Terminal Building, Car Wash, and Telephone System, as provided in Subsection 8.1, Concessionaire shall be obligated, without cost to City, to maintain the Leased Premises and every part thereof in good appearance, repair, and safe condition. Concessionaire shall maintain and repair all Leasehold Improvements on the Leased Premises and all furnishings, fixtures, and equipment therein, whether installed by Concessionaire or by others, including repainting or redecorating as necessary, and replacing or repairing worn carpet, tile, fixtures, or furnishings. All such maintenance and repairs shall be at least of quality equal to the original in materials and workmanship, and all work, including paint colors, shall be subject to the prior written approval of Executive Director of Aviation. Concessionaire shall be obligated, without cost to City, to provide custodial service to Leased Premises. Concessionaire shall be responsible for the replacement cost of lost keys and floor finish restoration.
- B. Hazardous Conditions. Upon discovery, Concessionaire shall immediately give oral notice to Airport of any hazardous or potentially hazardous conditions in the Leased Premises or in the Terminal Building. Any hazardous or potentially hazardous condition in the Leased Premises shall be

corrected immediately upon receipt of oral notice from the Executive Director of Aviation. At the direction of said Director, Concessionaire shall close the Leased Premises until such hazardous or potentially hazardous condition is removed.

- C. **Trash and Refuse.** City shall provide, at no cost to Concessionaire, a container for the adequate sanitary handling of all trash and other refuse caused as a result of the operation of the Leased Premises. Concessionaire shall be responsible for disposal of its own trash accumulations by depositing it in the nearest exterior trash dumpster on a daily basis. Concessionaire will regularly inspect exterior areas assigned to them and will remove all trash and debris. Failure to do so will result in the City completing this task and a fee assessed to the Concessionaire for the service. Trash receptacles inside the terminal building are for customer use only. Piling of boxes, cartons, barrels, or other similar items in view of a public area is prohibited. Concessionaire shall keep any areas used for trash and garbage storage prior to removal from Airport in a reasonably clean and orderly condition so as not to unduly attract rodents, pests, or birds, or create an offensive odor. Concessionaire also agrees to participate in the City's recycling program by depositing all recyclable products in the appropriate outside recycling containers in lieu of the trash dumpster.
- D. **Transporting Trash and Refuse.** In transporting trash and refuse from the Leased Premises, Concessionaire shall ensure that trash is not strewn around while taking refuse to the dump site. Such disposal shall take place during hours as may be approved by the City.
- E. **Damage to Equipment.** Concessionaire will be responsible for the cost of replacement equipment deemed to be damaged by their employees due to negligence.

SECTION 9 – LIENS, PAYMENT, AND PERFORMANCE BONDS

Subsection 9.1 Construction Surety Bond. Concessionaire shall not allow any liens or encumbrances to be attached to the Leased Premises. Prior to the commencement of any construction or alteration hereunder which exceeds \$10,000 in cost, Concessionaire or its contractor shall furnish to City, and without expense to City, a surety bond, issued by a surety company licensed to transact business in the State of Texas and satisfactory to and approved by City with Concessionaire's contractor or contractors as principals, in a sum not less than one hundred percent (100%) of the total cost of the contract or contracts for the construction or alteration of the improvements and facilities mentioned herein. Said bond shall guarantee the prompt payment to all persons supplying labor, materials, provisions, supplies, and equipment used directly or indirectly by said contractor, subcontractor(s), and suppliers in the prosecution of the work provided for in said construction contract and shall protect City from any liability, losses, or damages arising there from.

Subsection 9.2 Compliance with Federal Aviation Regulations, 14 CFR Part 139, and Transportation Security Administration security requirements 49 CFR Part 1542. Concessionaire agrees to comply with Federal Aviation Regulations, and 1542 (Airport Security), U.S. Army requirements, and the City's policies as outlined in City's approved Operations Plan and Airport Security Plan. Concessionaire further agrees that any fines levied upon the City or Concessionaire through enforcement of these regulations because of acts by Concessionaire's employees, agents, suppliers, guests, or patrons shall be borne by Concessionaire to the extent said acts contributed to said fines.

Subsection 9.3 Security. During the term of this Agreement, the City shall require the Operator to deliver (and thereafter maintain current for the entire term of this Agreement) an instrument of security in a form satisfactory to the City, in its sole discretion, in the amount of twenty-five percent (25%) of Concessionaire's Minimum Annual Guarantee for each year hereunder, in order to secure the performance of all of Concessionaire's obligations under this Agreement, including without limitation, the payment of all the percentages, minimums, fees, charges and costs set out herein. Said security may be in the form of a bond.

SECTION 10 – OPERATION OF LEASED PREMISES: HOURS AND DELIVERIES

Subsection 10.1 Hours of Operation. Concessionaire shall actively operate in the Leased Premises and shall use a business-like operation therein. The Concessionaire shall be open to serve the public seven (7) days per week and hours of operation shall be such that passengers of flights arriving or departing from the terminal will be accommodated. In no event shall the hours of operation be curtailed to an extent that the service contemplated under this Agreement shall be diminished. Except as otherwise stated herein, the hours of service shall be determined in light of changing public demands and airline operating schedules. Concessionaire may advise the Executive Director of Aviation of Concessionaire's analysis of the optimum arrangements, but the final determination shall be made by the Executive Director of Aviation based on their analysis of necessary service to the public.

Subsection 10.2 Delivery of Goods. Concessionaire shall arrange for the timely delivery of all motor vehicles and supplies, at such times, in such locations(s), and by such routes as determined by City. Concessionaire shall abide by all Transportation Security Administration (TSA) requirements for parking of motor vehicles near the terminal building.

Subsection 10.3 Utilities.

- A. City shall provide the Leased Premises with heat and air-conditioning to keep the Leased Premises at reasonable temperatures for the conduct of Concessionaire's activities. City shall have the right to set, monitor, adjust and restrict thermostat settings to levels it determines to be appropriate.

- B. City shall provide electricity to the Leased Premises by means of wiring installations, and Concessionaire shall make such connections as required and permitted by building code. At no time shall Concessionaire's use of electric current exceed the capacity of the wiring installation in place.

SECTION 11 – QUALITY AND CHARACTER OF SERVICE

Subsection 11.1 Type of Operation. Concessionaire shall maintain and operate the concession privileges granted hereunder in an orderly, proper, and first-class manner, which, in the sole judgment of Executive Director of Aviation, does not unduly annoy, disturb, or offend others at the Airport.

Subsection 11.2 Services to the General Public. Concessionaire understands and agrees that its operation at the Airport necessitates the rendering of public services such as giving directions, and generally assisting the public.

Subsection 11.3 Additional Compliance. Concessionaire shall comply with all applicable governmental laws, ordinances, and regulations in the conduct of its operations under this Agreement.

Subsection 11.4 Personnel.

- A. General. Concessionaire shall maintain a sufficient number of properly trained personnel to ensure that all customers of Concessionaire receive prompt and courteous service. All such personnel, while on or about the Leased Premises, shall be polite, clean, appropriately attired, and neat in appearance. Clothing will be neat and clean and present a professional appearance. Executive Director of Aviation shall have the right to object to the demeanor, conduct, and appearance of any employee of Concessionaire, or any of its invitees or those doing business with it, whereupon Concessionaire shall take all steps necessary to remedy the cause of the objection. Concessionaire will ensure that its counter is staffed at all times during the posted hours of operation.
- B. Manager. The management, maintenance, and operation of the Leased Premises and the concession conducted thereon shall be at all times during the term hereof under the supervision and direction of an active, qualified, competent, and experienced manager, who shall at all times be authorized to represent and act for Concessionaire. Concessionaire shall cause such manager to be available during normal business hours, and Concessionaire will at all times during the absence of such manager assign, or cause to be assigned, a qualified subordinate to assume and be directly responsible for the carrying out of his or her duties.

SECTION 12 – NON-DISCRIMINATION

This agreement is subject to the requirements of the U.S. Department of Transportation's regulations, 49 CFR Part 23, pursuant to law, it is unlawful and Concessionaire agrees not to willfully refuse to employ, to discharge, or to discriminate against any person otherwise qualified because of race, color, religion, sex, sexual orientation, age, disability, national origin or ancestry, lawful source of income, marital status, creed, or familial status; not to discriminate for the same reason in regard to tenure, terms, or conditions of employment, not to deny promotion or increase in compensation solely for these reasons; not to adopt or enforce any employment policy which discriminates between employees on account of race, color, religion, sex, creed, age, disability, national origin or ancestry, lawful source of income, marital status or familial status; not to seek such information as to any employee as a condition of employment; not to penalize any employee or discriminate in the selection of personnel for training, solely on the basis of race, color, religion, sex, sexual orientation, age, disability, national origin or ancestry, lawful source of income, marital status, creed or familial status.

Concessionaire shall include or cause to be included in each subcontract covering any of the services to be performed under this Agreement a provision similar to the above paragraph, together with a clause requiring such insertion in further subcontracts that may in turn be made.

SECTION 13 – IDEMNIFICATION AND INSURANCE

Subsection 13.1 Indemnification. To the fullest extent allowable by law, Concessionaire hereby indemnifies and shall defend and hold harmless, at Concessionaire's expense, City, its elected and appointed officials, committee members, officers, employees or authorized representatives or volunteers, from and against any and all suits, actions, legal or administrative proceedings, claims, demands, damages, liabilities, losses, interest, attorney's fees (including in-house counsel legal fees), costs and expenses of whatsoever kind, character or nature whether arising before, during, or after completion of the Agreement hereunder and in any manner directly or indirectly caused or contributed to in whole or in part, by reason of any act, omission, fault, or negligence, whether active or passive of Concessionaire, or of anyone acting under its direction or control or on its behalf in connection with or incident to the performance of this Agreement, regardless if liability without fault is sought to be imposed on City. Concessionaire's aforesaid indemnity and hold harmless agreement shall not be applicable to any liability caused by the negligent or willful misconduct of City, its elected and appointed officials, officers, employees or authorized representatives or volunteers. Nothing in this Agreement shall be construed as City waiving its statutory limitation and/or immunities as set forth in the applicable Texas Statutes or other applicable law. This indemnity provision shall survive the termination or expiration of this Agreement.

Concessionaire shall reimburse City, its elected and appointed officials, officers, employees or authorized representatives or volunteers for any and all legal expenses

and costs incurred by each of them in connection therewith or in enforcing the indemnity herein provided. Concessionaire's obligation to indemnify shall not be restricted to insurance proceeds, if any, received by City, its elected and appointed officials, officers, employees or authorized representatives or volunteers.

To the extent allowed by law, except for damage or injury caused by the willful or negligent act or omission of Concessionaire, its agents or employees, City shall indemnify, defend and save Concessionaire, its agents, representatives, and employees from any and all lawsuits, claims, loss and damages of any nature whatsoever, including damage to property of any Concessionaire and the injury, including death, of employees, agents, or customers of Concessionaire, arising either directly or indirectly out of any operations of the City hereunder, except lawsuits, claims, loss and damages arising out of the sole negligence of the Concessionaire, their employees, or agents.

Subsection 13.2 Concessionaire to Provide General Liability and Automobile Insurance. Concessionaire shall, at its sole expense, obtain and maintain in effect at all times during this Agreement the following insurance coverage:

- A. Commercial General Liability Insurance of not less than \$5,000,000 per occurrence for bodily injury, personal injury and property damage;
- B. Automobile Insurance of not less than \$5,000,000 per occurrence;
- C. To the extent that Concessionaire employs any employees or as otherwise required by law, Workers' Compensation and Employers' Liability Insurance with Texas statutory limits.

Subsection 13.3 Concessionaire to Provide Property and Fire Insurance. Concessionaire, at its own expense, shall insure all Leasehold Improvements and furnishings, fixtures and equipment for fire, extended coverage, vandalism, and malicious mischief. Such insurance shall be in an amount equal to the full insurable replacement value of such improvements. All property insurance policies shall contain loss payable endorsements in favor of the parties as their respective interests may appear hereunder and shall contain a waiver of subrogation provision in favor of the City. Concessionaire and City agree that any payments received by either from such insuring companies by reason of loss under such policy or policies shall be applied toward repair and reconstruction of said Leasehold Improvements and repair or replacement of leasehold improvements, furnishings, fixtures and equipment.

Subsection 13.4 Both Concessionaire and City to Carry Fire Insurance. It is understood that both Concessionaire and City carry insurance in the form of fire, extended coverage, vandalism, and malicious mischief (hereinafter called "Insurance Coverage") on the leased structural part of the premises, permanent improvements and loss of income, (in the case of City) and on Leasehold Improvements, furniture, furnishings, equipment, inventory and loss of income, (in the case of Concessionaire), and said Insurance Coverage authorizes a waiver of subrogation between City and Concessionaire, and the parties wish to enter into such waiver of subrogation to the

extent of the said Insurance Coverage; therefore, to the extent that City collects under its Insurance Coverage, City waives any and all claims against Concessionaire, its agents, servants, and employees, for loss or damage to City's property resulting from risks included in said Insurance Coverage; and, to the extent that Concessionaire collects under its Insurance Coverage, Concessionaire waives any and all claims against City, its agents, servants, and employees, for loss or damage to Concessionaire's property resulting from risks included in said Insurance Coverage. If this waiver by the parties shall render fully any such insurance policy or shall result in the denial of coverage for a party under such policy, then the provision paragraph shall be deemed to be null and void.

Subsection 13.5 Insurance Certificate. A certificate evidencing insurance required by Subsection 13.2 and 13.3, and listing the City of Killeen as additional insured, excluding Workers' Compensation and Property and Fire Insurance, shall be filed with City prior to the commencement of construction, furnishing and equipping of Leasehold Improvements by Concessionaire upon the Leased Premises, and such certificate shall provide that such Insurance Coverage will not be canceled or reduced without at least thirty (30) days prior written notice to City. Prior to the expiration of any such policy, a certificate showing that such Insurance Coverage has been renewed shall be filed with City. If such Insurance Coverage is canceled or reduced, Concessionaire shall within fifteen (15) days after receipt of written notice from City of such cancellation or reduction in coverage, file with City a certificate showing that the required insurance has been reinstated or provided through another insurance company or companies.

Subsection 13.6 Concessionaire Failure to Provide Certificates. In the event that Concessionaire shall at any time fail to furnish City with the certificate or certificates required under this Section, City, upon written notice to Concessionaire of its intention so to do, shall have the right to obtain the required insurance, at the cost and expense of Concessionaire, and Concessionaire agrees to promptly reimburse City for the cost thereof, plus fifteen percent (15%) thereof for administrative overhead.

SECTION 14 – DAMAGE OR DESTRUCTION OF LEASED PREMISES

Subsection 14.1 Partial Damage. If all or a portion of the Leased Premises is partially damaged by fire, explosion, the elements, public enemy, or other casualty, but not rendered untenable, the same will be repaired with due diligence by City subject to the limitations of Subsection 14.4; provided, however, to the extent that such damage or destruction is not covered by insurance, Concessionaire shall be responsible for reimbursing City for the cost and expenses insured in such repair to the extent that the damage is caused by the negligent act or omission of Concessionaire, its sublessees, agents, or employees.

Subsection 14.2 Extensive Damage. If the damages referred to in Subsection 14.1 shall be so extensive as to render the Terminal Building Premises untenable, but capable of being repaired in thirty (30) days, the same shall be repaired with due diligence by City subject to the limitations of Subsection 14.4; and the charges payable

herein for the MAG and Rent under Section 5.1 shall abate from the time of such damage or destruction until such time as the said Leased Premises are fully restored and certified by City's Engineers as ready for occupancy; provided, however, the said fees and charges will not abate and to the extent that such damage or destruction is not covered by insurance, Concessionaire shall be responsible for reimbursing City for the cost and expenses incurred in such repair to the extent that the damage is caused by the negligent act or omission of Concessionaire, its sublessees, agents, or employees.

Subsection 14.3 Complete Destruction. In the event the Terminal Building Premises are completely destroyed by fire, explosion, the elements, the public enemy, or other casualty, or so damaged that they are untenable and cannot be replaced for more than thirty (30) days, City shall undertake the repair, replacement, and reconstruction of said Leased Premises; and charges payable herein for the MAG and Rent under Section 5.1, shall abate as of the time of such damage or destruction until such time as the said Premises are fully restored and certified by City's Executive Director of Aviation as ready for occupancy; provided, however, the said fees and charges will not abate and to the extent that such damage or destruction is not covered by insurance, Concessionaire shall be responsible for reimbursing City for the costs and expenses incurred in said repair to the extent that the damage is caused by the negligent act or omission of Concessionaire, its sublessees, agents, or employees; provided further, however, if within twelve (12) months after the time of such damage or destruction said Leased Premises shall not have been repaired or reconstructed, Concessionaire may cancel this Agreement in its entirety. Rents payable for the leased areas in the Terminal Building and/or Ready/Return Block will only abate if the City is unable to provide alternative space for Concessionaire to conduct its business.

Subsection 14.4 Limits of City's Obligations Defined. It is understood that, in the application of the foregoing Subsections, City's obligations shall be limited to repair or reconstruction of the Leased Premises to the same extent and of equal quality as obtained at the commencement of operations hereunder, subject to funding and appropriation. Redecoration and replacement of furniture, fixtures, equipment, and supplies shall be the responsibility of Concessionaire and any such redecoration and refurbishing/re-equipping shall be of equivalent quality to that originally installed hereunder.

SECTION 15 – CANCELLATION

Subsection 15.1 Cancellation by Concessionaire. Concessionaire may cancel this Agreement and terminate all its obligations hereunder upon or after the happening of one or more of the following events and provided that Concessionaire is not in default in the payment of any fees or charges to City:

- A. The abandonment of the Airport as an airline terminal or the removal of all certificated passenger airline service from the Airport for a period of no less than thirty (30) consecutive days.
- B. The inability of Concessionaire to use the Airport for a period of longer than

ninety (90) days, because of the issuance of any order, rule, or regulation by any competent governmental authority or court having jurisdiction over Concessionaire or City, preventing Concessionaire from operating its business; provided, however, that such inability or such order, rule, or regulation is not primarily due to any fault of Concessionaire.

- C. The material breach by City in the performance of any covenant or agreement herein required to be performed by City and the failure of City to remedy such breach for a period of sixty (60) days after receipt from Concessionaire of written notice to remedy the same.

Subsection 15.2 Cancellation by City. City may cancel this Agreement and terminate all of its obligations hereunder at any time that City is not in default, upon or after the happening of any of the following events:

- A. Concessionaire shall file a voluntary petition in bankruptcy; or
- B. Proceedings in bankruptcy shall be instituted against Concessionaire and Concessionaire is thereafter adjudicated bankrupt pursuant to such proceedings; or
- C. A court shall take jurisdiction of Concessionaire and its assets pursuant to proceedings brought under the provisions of any federal reorganization act; or
- D. A receiver of Concessionaire's assets shall be appointed; or
- E. Concessionaire voluntarily abandons its conduct of its business at the Airport for a period of thirty (30) days, except if such is due to a labor strike or labor dispute in which Concessionaire is involved; or
- F. Any assignment is made by Concessionaire for the benefit of its creditors; or
- G. The material breach by Concessionaire of any of the covenants or agreements herein contained and the failure of Concessionaire to remedy such breach as hereinafter provided. In this regard it is understood that nonpayment of fees or charges hereunder is a material breach. In the event of such material breach, City shall give to Concessionaire notice in writing to correct such breach and if such breach shall continue for fifteen (15) days after the receipt of such notice by Concessionaire, City may, after the lapse of said fifteen (15) day period, cancel this Agreement, without forfeiture, waiver, or release of City's rights to any sum of money due or to become due under the provisions of this Agreement.
- H. The lawful assumption by the United States Government, or any authorized agency thereof, of the operation, control or use of the Airport and facilities, or any substantial part or parts thereof, in such manner as to substantially restrict Concessionaire, for a period of at least thirty (30) days, from its Airport

operation.

Subsection 15.3 Termination. Should an early termination of this Agreement occur pursuant to the terms of Subsection 15.2 hereof, City shall have the right to re-enter the Leased Premises, make repairs as necessary, and enter into another agreement for the Leased Premises and privileges, or any part thereof, for the remainder of the term hereof.

Subsection 15.4 Notice of Termination. If any of the events enumerated in Subsections 15.1 and 15.2 shall occur and after due notice the defaulting party has failed to cure or correct same, the complaining party may, at any time thereafter during the continuance of said default, terminate this Agreement by notice in writing, such cancellation and termination to be effective upon the date specified in such notice.

SECTION 16 – NONWAIVER OF RIGHTS

Continued performance by either party hereto pursuant to the terms of this Agreement after a default of any of the terms, covenants, and conditions herein contained to be performed, kept, or observed by the other party hereto shall not be deemed a waiver of any right to cancel this Agreement for any subsequent default; and no waiver of any such default shall be construed or act as a waiver of any subsequent default.

SECTION 17 – SURRENDER OF POSSESSION

Concessionaire shall, upon termination of this Agreement or cancellation, quit and deliver up the Leased Premises and privileges to City peaceably and quietly, with the Leased Premises being in as good order and condition as the same now are or may be hereafter improved by Concessionaire or City, reasonable use and wear thereof excepted. In addition to any lien provided by Texas law, City shall have a specific lien on all property of Concessionaire, and related equipment on the Leased Premises as security for nonpayment. Concessionaire shall have the right to remove all of its trade fixtures and equipment installed or placed by it at its own expense, in, on or about the Premises; subject however, to any valid lien which City may have thereon for unpaid charges or fees. Provided however, the City will not claim or have a lien of any kind, be it contractual or statutory, on or against Concessionaire's motor vehicles for non-payment of any rent or fees due under the Agreement, or for any default of Concessionaire or any other reason, and the City hereby waives all such liens available to the City.

SECTION 18 – TAXES AND LICENSES

Concessionaire shall obtain and pay for all licenses or permits necessary or required by law for the construction of improvements, the installation of equipment and furnishings, and any other licenses necessary for the conduct of its operations hereunder.

SECTION 19 – INSPECTION OF PREMISES

City or its duly authorized representatives, or agents, and other persons for it, may enter upon said Leased Premises at any and all reasonable times during the term of this Agreement for the purpose and conditions hereof or for any other purpose incidental to rights of City.

SECTION 20 – HOLDING OVER

Should Concessionaire holdover said Leased Premises after this Agreement has terminated in any manner, Concessionaire shall continue such holding over only at sufferance to City. In the event of such holding over, Concessionaire shall pay to the City the amounts specified in Subsection 5.1, the amounts being the amounts in effect immediately prior to the commencement of such holdover.” All other terms and conditions in such holdover shall be the same as herein provided.

SECTION 21 – QUIET ENJOYMENT

City agrees that Concessionaire, upon payment of the fees and charges and all other payments to be paid by Concessionaire under the terms of this Agreement, and upon observing and keeping the agreements and covenants of this Agreement on the part of Concessionaire to be observed and kept, shall lawfully and quietly hold, occupy, and enjoy the Leased Premises during the term of this Agreement.

SECTION 22 – NO LIENS

Concessionaire shall pay for all labor done or materials furnished in the repair, replacement, development, or improvement of the Premises by Concessionaire, and shall keep said Leased Premises and Concessionaire's possessory interest therein free and clear of any lien or encumbrance of any kind whatsoever created by Concessionaire's act or omission.

SECTION 23 – SECURITY AGREEMENTS

City shall provide, or cause to be provided, during the term of this Agreement, all proper and appropriate public fire and police protection similar to that afforded to other Landside tenants or licensees at the Airport, and it will issue and enforce rules and regulations with respect thereto for all portions of the Airport. Concessionaire shall comply with the Airport Security Plan and shall have the right, but shall not be obligated, to provide such additional or supplemental public protection as it may desire, but such right, whether or not exercised by Concessionaire, shall not in any way be construed to limit or reduce the obligations of City hereunder.

SECTION 24 – AGREEMENT SUBORDINATE TO AGREEMENTS WITH THE UNITED STATES

This Agreement is subject and subordinate to the terms, reservations, restrictions, and

conditions of any existing or future agreements between the City and the United States, the execution of which has been or may be required as a condition precedent to the transfer of federal rights or property to the City for Airport purposes, and the expenditure of federal funds for the extension, expansion, or development of the Killeen - Fort Hood Regional Airport. Should the effect of such Agreement with the United States government be to take any of the property under lease or substantially destroy the commercial value of such improvements, City shall terminate this Agreement.

SECTION 25 – RIGHTS AND PRIVILEGES OF CITY

- A. City shall have the right to enforce, and adopt from time to time, reasonable rules and regulations, which Concessionaire agrees to observe and obey, with respect to the use of the Airport, Airport Terminal Building and appurtenances, provided that such rules and regulations shall not be inconsistent with safety, current rules and regulations of the FAA, and any future changes prescribed from time to time by the FAA.
- B. The City Manager or designee is hereby designated as its official representative for the enforcement of all provisions in this Agreement with full power to represent City with dealings with Concessionaire in connection with the rights herein granted.
- C. All actions relating to policy determination, modification of this Agreement, termination of this contract, and any similar matters affecting the terms of this Agreement shall emanate from the City Council, their successors or assigns.
- D. The Executive Director of Aviation or designee may enter upon the Leased Premises, now or hereafter leased to Concessionaire hereunder, at any reasonable time, for any purpose necessary, incidental to, or connected with, the performance of its obligations hereunder, or in the exercise of its governmental functions.
- E. City reserves the right to further plan, develop, improve, remodel and/or reconfigure the Airport, including the Leased Premises and existing vehicle and pedestrian traffic patterns, as the City deems appropriate, regardless of the desires or views of Concessionaire, and without interference or hindrance.
- F. City hereby reserves for the use and benefit of the public, the right of aircraft to fly in the airspace overlying the land herein leased, together with the right of said aircraft to cause such noise as may be inherent in the operation of aircraft landing at, taking off from, or operating on or in the vicinity of Killeen - Fort Hood Regional Airport, and the right to pursue all operations of the Killeen - Fort Hood Regional Airport.
- G. City reserves the right to take any action it considers necessary to protect the aerial approaches of the Airport against obstruction, together with the right to prevent Concessionaire from erecting, or permitting to be erected, any

building or other structure on the Airport, which, in the opinion of the City, would limit the usefulness of the Airport, or constitute a hazard to aircraft.

- H. City may from time to time increase the size or capacity of any such Public Aircraft Facilities or Passenger Terminal Building or Common Use Portion of the Airport or make alterations thereto or reconstruct or relocate them or modify the design and type of construction thereof or close them or any portions of them, either temporarily or permanently, provided notice is given to Concessionaire.
- I. This Agreement at any time may be reopened for renegotiation if Federal Aviation Administration (FAA) Airport Certification (FAR Part 139), Transportation Security Administration (TSA) Security Requirements (49 CFR, Part 1542), or U.S. Army regulations result in major expenditures to City due to Concessionaire's tenancy on the Killeen - Fort Hood Regional Airport. If said renegotiation is desired, written notice must be given to Concessionaire sixty (60) days prior to such renegotiations.
- J. City reserves the right to relocate the Leased Premises upon the completion of any Terminal area remodeling or expansion. City will not be liable for the costs associated with the moving or reinstallation of Concessionaire's equipment. In the event the City requires a move by the Concessionaire, the City will reimburse actual out-of-pocket costs associated with the relocation as approved in advance subject to a maximum amount as established by the City.

SECTION 26 – ACCESS CONTROL

- A. Concessionaire shall upon termination of this agreement return all issued keys and access cards to City. If all issued keys and access cards are not returned to City at the termination of this Agreement Concessionaire shall pay to City cost to re-core premises locks and cut new keys at the rate set at the time of such re-core and to pay for any lost access cards.
- B. Concessionaire is responsible for all keys and access cards issued to employees of Concessionaire. Concessionaire is responsible to insure every employee that has regular duty at the Airport is submitted for airport electronic access cards appropriate for that employee and that all employee data remains current. The Concessionaire will notify the appropriate representative of the Airport by telephone or other appropriate means as soon as possible following the termination of any employee, but will do so in writing no later than the end of the next working day after the employee's last day of employment at the Airport. The Concessionaire is further responsible for returning the employee's electronic access cards no later than three (3) working days after the last day of employment at the Airport. Any lost electronic access cards must be reported in writing to the Airport's representative as soon as possible, but no later than the end of the next

working day from the date of the loss. Concessionaire is responsible for any charges or damages incurred by the use of electronic access cards issued to its employees unless more than 24 hours (excluding weekends and City of Killeen recognized holidays) have passed from the time the Concessionaire provides written notification to the Airport's representative to cancel any access these electronic access cards allow. A monthly fee will be charged for active employee electronic access cards and for lost cards at the current rates adopted by the City.

- C. Concessionaire may not install additional locks or change locks to Leased Premises without the written approval of the Executive Director of Aviation.

SECTION 27 – NO PERSONAL LIABILITY

Under no circumstances shall any trustee, officer, official, commissioner, Director, member, partner or employee of City have any personal liability arising out of this Agreement, and Concessionaire shall not seek or claim any such personal liability.

SECTION 28 – GOVERNING LAW

This Agreement and all questions and issues arising in connection herewith shall be governed by and construed in accordance with the laws of the State of Texas. Venue for any action arising out of or in any way related to this Agreement shall be exclusively in Bell County, Texas. Each party waives its right to challenge venue.

SECTION 29 – NOTIFICATION

Concessionaire shall:

- A. As soon as possible and in any event within a reasonable period of time after the occurrence of any default, notify City in writing of such default and set forth the details thereof and the action which is being taken or proposed to be taken by Concessionaire with respect thereto.
- B. Promptly notify City of the commencement of any litigation or administrative proceeding that would cause any representation and warranty of Concessionaire contained in this Agreement to be untrue.
- C. Notify City, and provide copies, immediately, upon receipt, of any notice, pleading, citation, indictment, complaint, order or decree from any federal, state or local government agency or regulatory body, asserting or alleging a circumstance or condition that requires or may require a financial contribution by Concessionaire or any guarantor or an investigation, clean-up, removal, remedial action or other response by or on the part of Concessionaire or any guarantor under any environmental laws, rules, regulations, ordinances or which seeks damages or civil, criminal or punitive penalties from or against Concessionaire or any guarantor for an alleged violation of any environmental

laws, rules, regulations or ordinances.

SECTION 30 – SEVERABILITY

The provisions of this Agreement are severable. If any provision or part of this Agreement or the application thereof to any person or circumstance shall be held by a court of competent jurisdiction to be invalid or unconstitutional for any reason, the remainder of this Agreement and the application of such provision or part thereof to other persons or circumstances shall not be affected thereby.

SECTION 31 – ASSIGNMENT, SUBLET, AND TRANSFER

Concessionaire shall not assign, sublet, or transfer its interests or obligations under the provisions of this Agreement without the prior written consent of City, which shall not be unreasonably withheld or delayed. This Agreement shall be binding on the heirs, successors, and assigns of each party hereto. Concessionaire shall provide not less than forty-five (45) days advance written notice of any intended assignment, sublet or transfer.

SECTION 32 – NO WAIVER

The failure of any party to insist, in any one or more instance, upon performance of any of the terms, covenants, or conditions of this Agreement shall not be construed as a waiver, or relinquishment of the future performance of any such term, covenant, or condition by any other party hereto but the obligation of such other party with respect to such future performance shall continue in full force and effect.

SECTION 33 – CONFLICTS OF INTEREST

Concessionaire covenants that it presently has no interest and shall not acquire any interest, direct or indirect, which would conflict in any manner or degree with the performance of its services hereunder. Concessionaire further covenants that in the performance of this Agreement no person having any conflicting interest shall be employed. Any interest on the part of Concessionaire or its employee must be disclosed to City.

SECTION 34 – POLITICAL ACTIVITIES

Concessionaire shall not engage in any political activities while in performance of any and all services and work under this Agreement.

SECTION 35 – ENTIRE AND SUPERSEDING AGREEMENT

This writing, all Exhibits hereto, and the other documents and agreements referenced herein, constitute the entire Agreement between the parties with respect to the subject matter hereof, and all prior agreements, correspondences, discussions and understandings of the parties (whether written or oral) are merged herein and made a

part hereof. This Agreement, however, shall be deemed and read to include and incorporate such minutes, approvals, plans, and specifications, as referenced in this Agreement, and in the event of a conflict between this Agreement and any action of City, granting approvals or conditions attendant with such approval, the specific action of City shall be deemed controlling.

SECTION 36 – AMENDMENT

This Agreement shall be amended only by formal written supplementary amendment. No oral amendment of this Agreement shall be given any effect. All amendments to this Agreement shall be in writing executed by both parties.

SECTION 37 – TIME COMPUTATION

Any period of time described in this Agreement by reference to a number of days includes Saturdays, Sundays, and any state or national holidays. Any period of time described in this Agreement by reference to a number of business days does not include Saturdays, Sundays or any state or national holidays. If the date or last date to perform any act or to give any notices is a Saturday, Sunday or state or national holiday, that act or notice may be timely performed or given on the next succeeding day which is not a Saturday, Sunday or state or national holiday.

SECTION 38 – NOTICES

NOTICES. Any notice, demand, certificate or other communication under this Agreement shall be given in writing and deemed effective: a) when personally delivered; b) three (3) days after deposit within the United States Postal Service, postage prepaid, certified, return receipt requested; or c) one (1) business day after deposit with a nationally recognized overnight courier service, addressed by name and to the party or person intended as follows:

To the City:	Killeen - Fort Hood Regional Airport Attn: Executive Director of Aviation 8101 S. Clear Creek Rd, Box C Killeen, TX 76549	Copy to: Attn. City Attorney City of Killeen 101 N. College St., 1 st Floor Killeen, TX 76541
--------------	--	---

To the Concessionaire: EAN Holdings, LLC d/b/a Alamo Rent A Car and National Car Rental
4210 South Congress Avenue
Austin, TX 78745

The parties may designate other addresses from time to time in writing. Concessionaire must provide a valid new address for notices within ten (10) days if the above address becomes invalid.

SECTION 39 – CONSTRUCTION

This Agreement shall be construed without regard to any presumption or rule requiring construction against the party causing such instrument to be drafted. This Agreement shall be deemed to have been drafted by the parties of equal bargaining strength. The captions appearing at the first of each numbered section of this Agreement are inserted and included solely for convenience but shall never be considered or given any effect in construing this Agreement with the duties, obligations, or liabilities of the respective parties hereto or in ascertaining intent, if any questions of intent should arise. All terms and words used in this Agreement, whether singular or plural and regardless of the gender thereof, shall be deemed to include any other number and any other gender as the context may require.

SECTION 40 – NO THIRD PARTY BENEFICIARY

Nothing contained in this Agreement, nor the performance of the parties hereunder, is intended to benefit, nor shall inure to the benefit of, any third party.

SECTION 41 – COMPLIANCE WITH LAW

The parties shall comply in all material respects with any and all applicable federal, state and local laws, regulations and ordinances.

SECTION 42 – FORCE MAJEURE

City shall not be responsible to Concessionaire and Concessionaire shall not be responsible to City for any resulting losses and it shall not be a default hereunder if the fulfillment of any of the terms of this Agreement is delayed or prevented by revolutions or other civil disorders, wars, acts of enemies, strikes, fires, floods, acts of God, adverse weather conditions, legally required environmental remedial actions, industry-wide shortage of materials, or by any other cause not within the control of the party whose performance was interfered with, and which exercise of reasonable diligence, such party is unable to prevent, whether of the class of causes hereinabove enumerated or not, and the time for performance shall be extended by the period of delay occasioned by any such cause.

SECTION 43 – GOOD STANDING

Concessionaire affirms that it is a company duly formed and validly existing and in good standing under the laws of the State of Texas and has the power and all necessary licenses, permits and franchises to own its assets and properties and to carry on its business. Concessionaire is duly licensed or qualified to do business and is in good standing in the State of Texas and in all other jurisdictions in which failure to do so would have a material adverse effect on its business or financial condition.

SECTION 44 – INDEPENDENT CONTRACTORS

The parties, their employees, agents, volunteers, and representative shall be deemed independent contractors of each other and shall in no way be deemed as a result of this Agreement to be employees of the other. The parties, their employees, agents, volunteers, and representatives are not entitled to any of the benefits that the other provides for its employees. The parties shall not be considered joint agents, joint ventures, or partners.

SECTION 45 – GOVERNMENTAL APPROVALS

Concessionaire acknowledges that various of the specific undertakings of City described in this Agreement may require approvals from the City of Killeen City Council, City of Killeen bodies, and/or other public bodies, some of which may require public hearings and other legal proceedings as conditions precedent thereto. Concessionaire further acknowledges that this Agreement is subject to appropriation by the Killeen City Council. City's obligation to perform under this Agreement is conditioned upon obtaining all such approvals in the manner required by law. City cannot assure that all such approvals will be obtained, however, it agrees to use good faith efforts to obtain such approvals on a timely basis.

SECTION 46 – AUTHORITY

The persons signing this Agreement warrant that they have the authority to sign as, or on behalf of, the party for whom they are signing.

SECTION 47 – COUNTERPARTS

This Agreement may be executed in one or more counterparts, all of which shall be considered but one and the same agreements and shall become effective when one or more counterparts have been signed by each of the parties and delivered to the other party.

SECTION 48 – SURVIVAL

All express representations, indemnifications and limitations of liability included in this Agreement will survive its completion or termination for any reason.

SECTION 49 – MORE FAVORABLE TERMS

In the event the City shall enter into any lease or agreement with any other rental car operator within the Airline Terminal building, that agreement will not contain more favorable terms than this Agreement, unless the same rights, privileges, and more favorable terms are concurrently made available to Concessionaire.

SECTION 50 – ENVIRONMENTAL

Subsection 50.1 Disposal, Use and Storage of Hazardous Materials. Disposal of Hazardous Materials on the Airport is strictly prohibited. Storage and use of Hazardous Materials on the Airport is prohibited, except:

- A. Concessionaire may store and use Hazardous Materials on the Leased Premises in a safe and prudent manner and in accordance with the requirements of all applicable Environmental Laws but only for those kinds and quantities of Hazardous Materials that are normally used in conducting the activities permitted under this Agreement. Storage shall be in an approved Hazardous Materials cabinet or storage container. Concessionaire shall provide Executive Director of Aviation with a copy of any application for a permit for use or storage of Hazardous Materials on the Leased Premises from any regulatory agency responsible for enforcement of Environmental Laws, and shall also a copy of any permit received from such agency; and
- B. Concessionaire may use Hazardous Materials on the Airport other than the Leased Premises only in a safe and prudent manner and in accordance with the requirements of all applicable Environmental Laws but only for those kinds and quantities of Hazardous Materials which are commonly used in conducting the activities permitted under this Agreement.

Subsection 50.2 Liability. Concessionaire shall be solely and fully responsible and liable for:

- A. Storage, use or disposal of Hazardous Materials on the Leased Premises or the Airport, by Concessionaire, Concessionaire's officers, agents, employees, or contractors,
- B. Any Hazardous Material release which is caused by or results from the activities of Concessionaire, Concessionaire's officers, agents, employees, or contractors on the Leased Premises or the Airport.

Subsection 50.3 Prevention of Release. Concessionaire shall take all necessary precautions to prevent its activities from causing any Hazardous Material release to occur on the Leased Premises or the Airport, including, but not limited to any release into soil, groundwater, or City's sewage or storm drainage system.

Subsection 50.4 Obligation to Investigate and Remediate. Concessionaire, at Concessionaire's sole cost and expense, shall promptly investigate and remediate, in accordance with requirements of all applicable Environmental Laws:

- A. Any release or threat of release of Hazardous Material on the Leased Premises or the Airport, including, but not limited to, into soil or groundwater, or City's sewage or storm drainage system which was caused or results in whole or in part from the activities of Concessionaire, Concessionaire's

officers, agents, employees, contractors, permittees or invitees; except that Concessionaire shall have no responsibility for any release or threat of release of Hazardous Material which Concessionaire establishes was caused by the sole negligence or willful misconduct of City, City's officers, agents, employees, contractors or permittees by any third party, or by migration of Hazardous Materials onto the premises from a specifically identifiable source off the use premises. In addition to all other rights and remedies of City hereunder, if Concessionaire does not promptly commence, and diligently pursue to remediate, to the extent required, any such release, or threat of release, of Hazardous Materials for which it has responsibility under this section, City, in its discretion, may pay to have same remediated and Concessionaire shall reimburse City plus a fifteen percent administration fee within fifteen (15) business days of City's demand for payment. The failure to commence investigation and provide City with a schedule for diligent completion of the remediation within thirty (30) days after discovery of such release, or threat of release, of Hazardous Material shall constitute prima facie evidence of failure to promptly commence remediation. The demand for payment by City shall be prima facie evidence that expense was incurred by City.

Subsection 50.5 Records and Inspections.

- A. Concessionaire will maintain a chemical inventory list and material safety data sheets of hazardous materials stored on site in accordance with state and federal regulations. The Concessionaire will also maintain manifests for all hazardous or regulated wastes transported and disposed of off-site.
- B. Upon reasonable notice by City, Concessionaire shall make available for review by City such records pertaining to the use, handling and disposal of any Hazardous Material(s) as Concessionaire is required to maintain under this section.
- C. City shall have the right, under the terms hereof, and upon reasonable notice for exclusive use space, to enter the Leased Premises during the Term hereof to conduct periodic environmental inspections and testing. City shall conduct each inspection or test in a manner that does not unreasonably interfere with Concessionaire's operations.

Subsection 50.6 Concessionaire Obligations upon Termination. Prior to vacating the Leased Premises, and in addition to all other requirements under this Agreement, Concessionaire shall remove any containers of Hazardous Materials placed on the Leased Premises during the Term by Concessionaire or as a result of Concessionaire's use or occupancy of the Leased Premises during the Term and shall demonstrate to City's reasonable satisfaction that such removal is in compliance with all applicable Environmental Laws, including without limitation conducting any environmental audits as may be required by City.

Subsection 50.7 Storm Water.

- A. Notwithstanding any other provisions or terms of this Agreement, Concessionaire acknowledges that certain properties within the Airport, or on City-owned land, are subject to storm water rules and regulations. Concessionaire agrees to observe and abide by such storm water rules and regulations as may be applicable to City's property and Concessionaire's uses thereof.
- B. Concessionaire acknowledges that any storm water discharge permit issued to City may name Concessionaire as a co-permittee. City and Concessionaire both acknowledge that close cooperation is necessary to insure compliance with any storm water discharge permit terms and conditions, as well as to insure safety and to minimize cost of compliance. Concessionaire acknowledges further that it may be necessary to undertake such actions to minimize the exposure of storm water to "significant materials" generated, stored, handled or otherwise used by Concessionaire, as such term may be defined by applicable storm water rules and regulations, by implementing and maintaining "best management practices" as that term may be defined in applicable storm water rules and regulations.
- C. City will provide Concessionaire with written notice of any storm water discharge permit requirements applicable to Concessionaire and with which Concessionaire will be obligated to comply from time-to-time, including, but not limited to: certification of non-storm water discharges; collection of storm water samples; preparation of storm water pollution prevention or similar plans; implementation of best management practices; and maintenance of necessary records. Such written notice shall include applicable deadlines. Concessionaire agrees that within thirty (30) days of receipt of such written notice it shall notify City in writing if it disputes any of the storm water permit requirements it is being directed to undertake. If Concessionaire does not provide such timely notice, Concessionaire will be deemed to assent to undertake such storm water permit requirements. In that event, Concessionaire agrees to undertake, at its sole expense, unless otherwise agreed to in writing between City and Concessionaire, those storm water permit requirements for which it has received written notice from City, and Concessionaire agrees that it will hold harmless and indemnify City for any violations or non-compliance with any such permit requirements.

SECTION 51 – ISRAEL CLAUSE

Concessionaire hereby verifies that it does not boycott Israel and will not boycott Israel during the term of this Agreement. Boycotting Israel is defined in Texas Government Code section 808.001 to mean refusing to deal with, terminating business activities with, or taking any action that is intended to penalize, inflict economic harm on, or limit commercial relations specifically with Israel, or with a person or entity doing business in Israel or in an Israeli-controlled territory, but does not include an action made for

ordinary business purposes.

IN WITNESS WHEREOF, the parties have executed this Agreement in duplicate on this ____ day of _____, 2018.

ATTEST:

CITY OF KILLEEN:

Lucy Aldrich
City Secretary

Ronald L. Olson
City Manager

ATTEST:

EAN Holdings, LLC

(name of signing authority)

(title)

EXHIBIT A1 - COUNTER/OFFICE/QUEUING AREAS

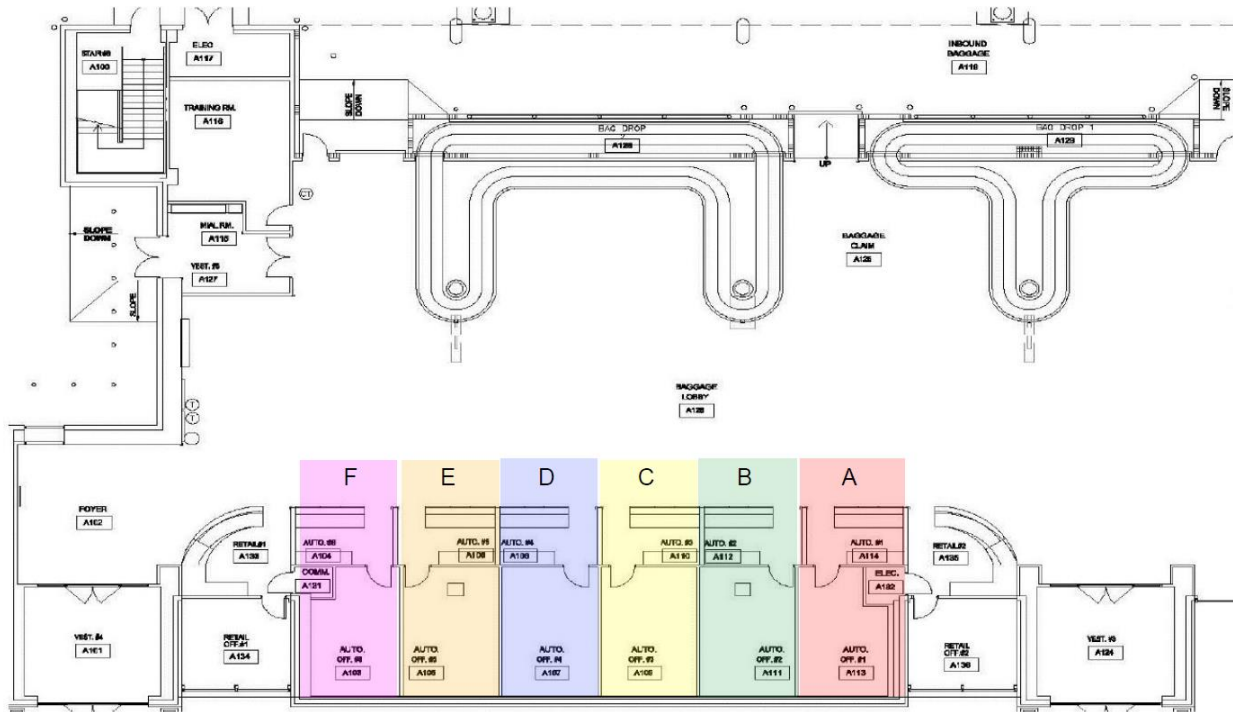

Space	Office	Counter Area	Queuing	Total Square Footage	Counter Length
A	199	107	102	408	12' 9"
B	232	109	103	444	12' 10"
C	232	109	103	444	12' 10"
D	232	109	103	444	12' 10"
E	232	109	103	444	12' 10"
F	199	104	102	405	12' 9"

REVISED EXHIBIT A2 - READY/RETURN BLOCKS AND SERVICE BAYS

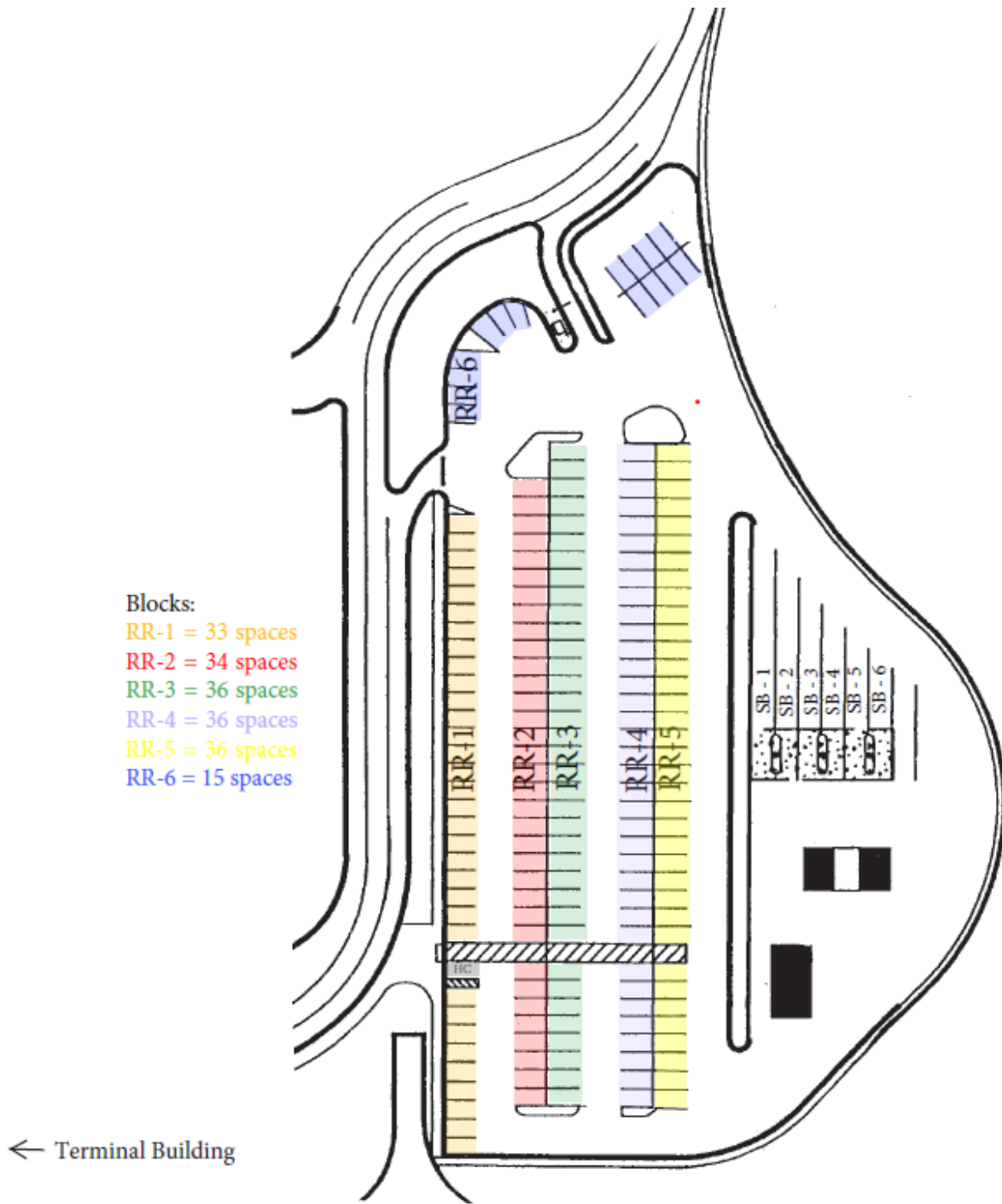

EXHIBIT A3 - STORAGE AREA

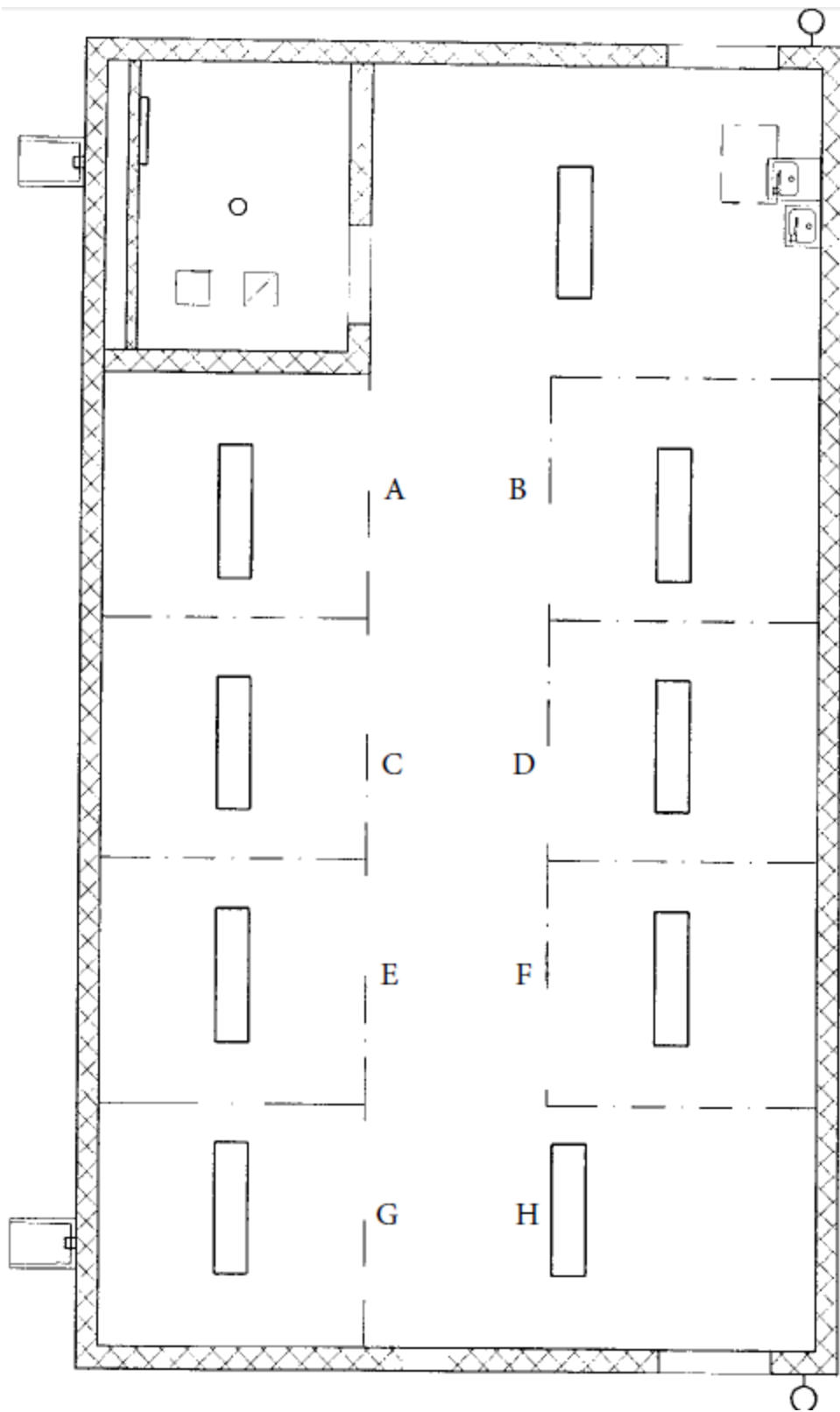

EXHIBIT A4 – OVERFLOW PARKING LANES

RENTAL CAR OVERFLOW PARKING LOT

27 - LANES
Each lane 8'6" x 85'

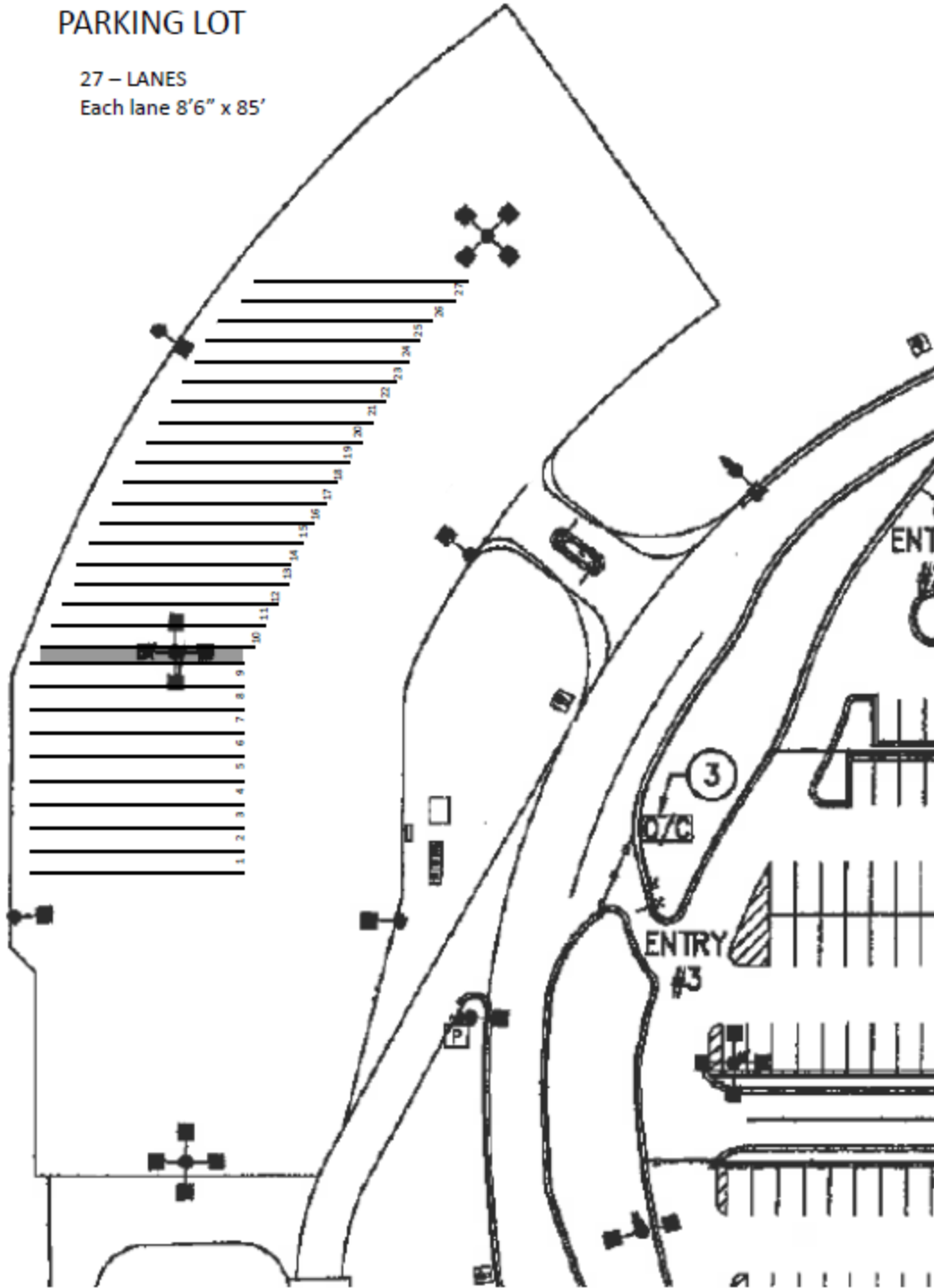

EXHIBIT B

KILLEEN – FORT HOOD REGIONAL AIRPORT
RENTAL CAR MONTHLY REPORT OF GROSS REVENUES
FOR MONTH OF _____

Concessionaire Name: _____

Address: _____

City, State, Zip: _____

Contact Name: _____

Phone # _____

GROSS RENTAL REVENUE: _____

Airport Fee (10%) _____

Less Monthly Guarantee paid 1st of month: _____

(1) Privilege Fee Balance Due: _____

Number of Transaction: _____

Number of Transaction Days: _____

(2) CFC Due (@ \$3.00 per Transaction Day): _____

Amount Due with this report (1) +(2): \$ _____

Concessionaire Official Signing and Certifying accuracy of Information on this report:

Signature _____

Typed Name & Title _____

Date signed _____

REMIT THIS FORM AND PAYMENT TO: City of Killeen Finance Department
Attn: Accounts Receivable
P.O. Box 1329
Killeen, TX 76540

CONCESSION AGREEMENT

NON-EXCLUSIVE RENTAL CAR CONCESSION
Killeen - Fort Hood Regional Airport
Killeen, Texas

between

Killeen - Fort Hood Regional Airport
City of Killeen, Texas

and

Clearwater Transportation, Ltd. d/b/a Dollar/Thrifty Car Rental

<u>Section</u>	<u>Page</u>
DEFINITIONS	6
SECTION 1 – LEASED PREMISES.....	9
SECTION 2 – TERM	9
SECTION 3 – USES, PRIVILEGES, COBRANDING AND OBLIGATIONS	9
SECTION 4 – RESTRICTIONS ON USES AND PRIVILEGES.....	11
SECTION 5 – PRIVILEGE FEE, RENTS, FEES AND ACCOUNTING RECORDS.....	11
Subsection 5.1 Privilege Fee, Rent and Fees.	11
Subsection 5.2 Statements, Books, and Records; Delinquent Rentals.	16
Subsection 5.3 Audit.....	17
SECTION 6 – INSTALLATION OF IMPROVEMENTS AND DESIGN, FURNISHING, AND EQUIPPING OF PREMISES	17
Subsection 6.1 Building Services	17
Subsection 6.2 Approval of Plans and Specifications; Provision of Drawings.....	17
SECTION 7 – TITLE TO IMPROVEMENTS, STRUCTURAL ALTERATIONS, ETC.	19
Subsection 7.1 Title.....	19
Subsection 7.2 Structural Alterations.....	19
Subsection 7.3 Alterations and Improvements to Airport.....	19
Subsection 7.4 Removal and Demolition.....	19
SECTION 8 – MAINTENANCE OF PREMISES	19
Subsection 8.1 Airport Maintenance Obligations.	19
Subsection 8.2 Concessionaire's Maintenance Obligations.	20
SECTION 9 – LIENS, PAYMENT, AND PERFORMANCE BONDS.....	21
Subsection 9.1 Construction Surety Bond.	21
Subsection 9.2.....	22
Subsection 9.3.....	22

SECTION 10 – OPERATION OF LEASED PREMISES: HOURS AND DELIVERIES	22
Subsection 10.1 Hours of Operation.....	22
Subsection 10.2 Delivery of Goods.	22
Subsection 10.3 Utilities.	23
 SECTION 11 – QUALITY AND CHARACTER OF SERVICE.....	23
Subsection 11.1 Type of Operation.	23
Subsection 11.2 Services to the General Public.....	23
Subsection 11.3 Additional Compliance.	23
Subsection 11.4 Personnel.....	23
 SECTION 12 – NON-DISCRIMINATION.....	24
 SECTION 13 – IDEMNIFICATION AND INSURANCE.....	24
Subsection 13.1 Indemnification.....	24
Subsection 13.2 Concessionaire to Provide General Liability and Automobile Insurance.	25
Subsection 13.3 Concessionaire to Provide Property and Fire Insurance.....	25
Subsection 13.4 Both Concessionaire and City to Carry Fire Insurance.	25
Subsection 13.5 Insurance Certificate.	26
Subsection 13.6 Concessionaire Failure to Provide Certificates.	26
 SECTION 14 – DAMAGE OR DESTRUCTION OF LEASED PREMISES	26
Subsection 14.1 Partial Damage.	26
Subsection 14.2 Extensive Damage.....	27
Subsection 14.3 Complete Destruction.	27
Subsection 14.4 Limits of City's Obligations Defined.....	27
 SECTION 15 – CANCELLATION	27
Subsection 15.1 Cancellation by Concessionaire.....	27
Subsection 15.2 Cancellation by City.	28
Subsection 15.3 Termination.	29
Subsection 15.4 Notice of Termination.....	29
 SECTION 16 – NONWAIVER OF RIGHTS	29
 SECTION 17 – SURRENDER OF POSSESSION	29
 SECTION 18 – TAXES AND LICENSES	29

SECTION 19 – INSPECTION OF PREMISES	30
SECTION 20 – HOLDING OVER	30
SECTION 21 – QUIET ENJOYMENT	30
SECTION 22 – NO LIENS.....	30
SECTION 23 – SECURITY AGREEMENTS	30
SECTION 24 – AGREEMENT SUBORDINATE TO AGREEMENTS WITH THE UNITED STATES	31
SECTION 25 – RIGHTS AND PRIVILEGES OF CITY	31
SECTION 26 – ACCESS CONTROL	32
SECTION 27 – NO PERSONAL LIABILITY	33
SECTION 28 – GOVERNING LAW.....	33
SECTION 29 – NOTIFICATION	33
SECTION 30 – SEVERABILITY	34
SECTION 31 – ASSIGNMENT, SUBLET, AND TRANSFER	34
SECTION 32 – NO WAIVER	34
SECTION 33 – CONFLICTS OF INTEREST	34
SECTION 34 – POLITICAL ACTIVITIES.....	34
SECTION 35 – ENTIRE AND SUPERSEDING AGREEMENT	35

SECTION 36 – AMENDMENT	35
SECTION 37 – TIME COMPUTATION	35
SECTION 38 – NOTICES	35
SECTION 39 – CONSTRUCTION.....	36
SECTION 40 – NO THIRD PARTY BENEFICIARY	36
SECTION 41 – COMPLIANCE WITH LAW	36
SECTION 42 – FORCE MAJEURE.....	36
SECTION 43 – GOOD STANDING.....	36
SECTION 44 – INDEPENDENT CONTRACTORS	37
SECTION 45 – GOVERNMENTAL APPROVALS.....	37
SECTION 46 – AUTHORITY.....	37
SECTION 47 – COUNTERPARTS.....	37
SECTION 48 – SURVIVAL.....	37
SECTION 49 – MORE FAVORABLE TERMS.....	37
SECTION 50 – ENVIRONMENTAL.....	38
SECTION 51 – ISRAEL CLAUSE	40
EXHIBIT A1 - COUNTER/OFFICE/QUEUING AREAS	42
EXHIBIT A2 - READY/RETURN BLOCKS AND SERVICE BAYS	43

EXHIBIT A3 – STORAGE AREA..... 43

EXHIBIT A4 – OVERFLOW PARKING LANES..... 44

EXHIBIT B..... 45

RENTAL CAR CONCESSION
Killeen - Fort Hood Regional Airport
Killeen, Texas

THIS CONCESSION AGREEMENT ("**Agreement**"), made and entered into this 1st day of January, 2019, by and between the City of Killeen (the "**City**"), a municipal corporation and existing under the laws of the State of Texas, whose address is 8101 S. Clear Creek Rd, Box C, Killeen, Texas 76549, hereinafter referred to as "City" and "Clearwater Transportation, Ltd." operating as Dollar/Thrifty Car Rental, (hereinafter referred to as "**Concessionaire**"), a limited company with its office and address being 6013 Fountainwood, San Antonio, TX 78233, with a mailing address of 6013 Fountainwood, San Antonio, TX 78233.

WITNESSETH:

WHEREAS, City controls, owns, operates, and maintains an airport in the City of Killeen, County of Bell, State of Texas, known as Killeen - Fort Hood Regional Airport (hereinafter referred to as "Airport"), and has the power to grant rights and privileges with respect thereto, and

WHEREAS, the City has determined it to be in the best interests of the public and the City to enter into this Agreement with Concessionaire to provide rental car concession services at the Airport pursuant and subject to the terms and conditions hereunder,

NOW, THEREFORE, THE PARTIES AGREE:

DEFINITIONS

The following terms and phrases shall have the following meanings for purposes of this Agreement:

1. "ACDBE" shall mean airport concession disadvantaged business enterprise as that term is defined by 49 CFR Part 23.
2. "City" shall mean the municipal corporation existing under the laws of the State of Texas which controls, operates, and maintains the Killeen - Fort Hood Regional Airport.
3. "Environmental Law" shall mean any federal, state or local law, rule, regulation, order or requirement relating to protection of human health and safety or the environment.
4. "Executive Director of Aviation" shall mean the Executive Director of Aviation of the City's Airport, or his or her designee.
5. "Gross Revenues" as used herein shall mean, as determined in the reasonable discretion of the City, all amounts charged to its customers by Concessionaire for or

in connection with agreements it secures through its operations and business at the Airport, regardless of whether such amount is actually paid to or received by Concessionaire. Gross Revenues shall include all monies or other consideration of whatsoever nature paid or payable to Concessionaire by customers for all sales made and services performed for cash, credit or consideration in connection with automobile and vehicle rentals or other products or services provided to persons through Concessionaire's operations at the Airport, without regard to the ownership, area, fleet, or location assignment of vehicles and without regard to the manner in which or place at which the vehicles or other products or services are furnished to Concessionaire's customers and without regard to whether the vehicles or other products are returned to the Airport or to some other location.

Gross Revenues shall include anything and everything that is not specifically excluded. The only exclusions from Gross Revenues permitted under this Agreement shall be the specific exclusions set forth below:

- Federal, state, county, city or municipal sales, use, or excise taxes now in effect or hereinafter levied on Concessionaire's operations which are separately stated on customers' rental contracts and collected from customers of Concessionaire;
 - Those fees referred to in this Agreement as Customer Facility Charges, "CFCs" which for the purpose of this Agreement shall include all customer facility charges, authorized pursuant to City Resolution, as may be amended;
 - Amounts received specifically for the actual loss of or damages of vehicles or other property of Concessionaire;
 - Amounts received from the sale of vehicles off-Airport premises; provided, however, any amounts paid in connection with automobile and vehicle rentals or other products or services provided to persons through Concessionaire's operations that are applied to or otherwise reimbursed as a result of the sale of a vehicle shall not be excluded from Gross Revenues; and
 - Reimbursements for amounts actually paid for speeding tickets, parking tickets, red light tickets, tolls and toll violations, and towing and impound fees from its customers to pass through without markup to an independent third party with no amount being retained by Concessionaire. However, any amounts collected above the pass through amount shall be included as Gross Revenue under this Agreement.
6. "Hazardous Material" shall mean any material that, because of its quantity, concentration or physical or chemical characteristics, is deemed by any federal, state or local governmental authority to pose a present or potential hazard to human health or safety or to the environment, and includes any material or substance

identified, listed, or defined as a "hazardous waste" "hazardous substance," or "pollutant" or "contaminant" or term of similar import, or is otherwise regulated pursuant to Environmental Laws, including any asbestos and asbestos-containing materials; petroleum, including crude oil or any fraction thereof, natural gas or natural gas liquids.

7. "Leasehold Improvements" shall mean all improvements and equipment which are affixed to the Leased Premises and which cannot be removed without material damage to the Premises.
8. "Operations Year" shall mean January 1 through December 31 annually.
9. "Personal Property" shall mean all movable property of the Concessionaire not directly related to the rental car operations of the privileges granted hereunder, including, office furniture, office equipment, and office supplies.
10. "Refurbish" or "Refurbishment" shall mean the routine repainting or redecoration of public areas within the Leased Premises, as necessary, including the replacement or repair of worn carpet, tile, furniture, or furnishings.
11. "Rental Car" or "Motor Vehicles" shall mean motor vehicles designed primarily for the carriage of passengers and commonly classified as sedans, coupes, convertibles, station wagons, four-wheel drive vehicles, passenger vans, sport utility vehicles, and pick-up trucks rated one-ton or less. Concessionaire shall not park, store, or rent from Premises any vehicles except Motor Vehicles as defined herein that it owns or rents and are properly available for rental as provided herein.
12. "Terminal Building" shall mean the terminal building at the Airport.
13. "Trade Fixtures" shall mean all non-affixed items, except expendables and Personal Property, which can be removed without damage to the Leased Premises, including cash registers, safes, patron tables and chairs, display fixtures, and the like.
14. "Transaction" shall mean the execution of an agreement or contract for the rental of a Motor Vehicle; or, the payment of funds or completion of a cash or credit transaction for payment for rental of a Motor Vehicle; or delivery of a Motor Vehicle to a customer for use in exchange for cash, credit or any other consideration.
15. "Transaction Day" shall mean each twenty-four (24) hour period or portion thereof, for which a customer of a Rental Car concessionaire rents, or otherwise enters into a similar arrangement for the use of a Motor Vehicle and for which the Rental Car concessionaire collects revenue from the customer. Late returns (after twenty four (24) hours) shall be considered a Transaction Day.

SECTION 1 – LEASED PREMISES

- A. City hereby leases to Concessionaire and Concessionaire hereby agrees to lease from City the following premises, which, collectively, are hereinafter called the "Leased Premises": Four Hundred and Forty Four (444) square feet of counter/office/queuing area "B" in the terminal building, Block "RR-5" the ready return area containing approximately thirty six (36) ready/return parking spaces outside and adjacent to the terminal building, Service Bay "3" and the associated queuing lane, and Storage Area "A". Said Leased Premises is more particularly shown on **Exhibits A1, A2, and A3** attached hereto and by this reference made a part hereof.
- B. Concessionaire agrees that its Leased Premises have been inspected by Concessionaire and are accepted and will be occupied by Concessionaire on an "as is" basis. The Concessionaire specifically waives any covenants or warranties regarding the Premises, including but not limited to any warranty of suitability and warranty of fitness.

SECTION 2 – TERM

The term of this Agreement is for a five (5) year period commencing on January 1, 2019 and terminating on December 31, 2023 unless sooner terminated or canceled as hereinafter provided.

SECTION 3 – USES, PRIVILEGES, COBRANDING AND OBLIGATIONS

Concessionaire shall have the following uses, privileges, and obligations in connection with its use of the Leased Premises:

- A. The non-exclusive right, privilege, and obligation to conduct and operate a rental car, van or truck rental concession at the Airport. Co-Branding by Concessionaire is limited to two brands per concession space specifically those listed in their submitted proposal. It being understood that no more than two brands under rental car agencies which are owned by the same parent company may operate from any one concession space during the term of this agreement. Concessionaire understands and agrees that it shall not engage in any other business on the Airport under this Agreement.
- B. The right, privilege, and obligation to rent and check-in rental vehicles, including the right to offer for sale related collision damage waiver protection, personal injury and accident insurance, personal effects insurance, and such other travel or vehicle related coverage offered in connection with and incidental to the rental of a vehicle and occupy operations office, storage, and Ready and Return car parking spaces. It is the intent of this Agreement that rental car customers of Concessionaire will operate the vehicle rented only from the ready spaces provided herein, and Concessionaire shall not engage in customer shuttle operations of any kind to, from, or on the Airport. This does not prohibit the

picking up of a customer from the Fixed Base Operator (FBO). No trucks larger than ¾ ton pickup type/style will be allowed in the ready lot unless approved in writing in advance by the Executive Director of Aviation.

- C. The non-exclusive right and privilege to wash vehicles rented by Concessionaire under the provisions of this Agreement in the City's car wash.
- D. The right and privilege to service vehicles rented by the Concessionaire under the provisions of this Agreement in the service bay identified in Section 1. Concessionaire shall use the service bay for the following activities only: vehicle automated and hand washing, cleaning, fluid replacement, vacuuming, and related activities as are necessary for preparing its vehicles for rental. No washing or vehicle maintenance may be conducted in the rental car parking lot or overflow parking areas.
- E. The right of ingress and egress to and from the Premises, over Airport roadways, are subject to such reasonable rules and regulations as may be established by Airport as respecting such use and subject to law.
- F. Concessionaire shall install no signs on or about the Premises without the prior written approval of the Executive Director of Aviation, said approval being solely discretionary with the Executive Director of Aviation. For purposes of this Section, signs shall include, but not necessarily be limited to, identification signs, company logos, advertising or promotions, photographs, art displays, and the like. Such signs shall be substantially uniform in size, types and location with those of other concessionaries, and subject to Executive Director of Aviation's approval, Rules and Regulations, and in compliance with all applicable laws and resolutions. No temporary signs or displays shall be permitted on the backwall or the counter surfaces without the prior written approval of the Executive Director of Aviation. Handwritten, or hand lettered signs are prohibited. Concessionaire shall not place or install any racks, stands, trade fixtures, pedestal signs, or other displays of products outside the boundaries of the Leased Premises without the express prior written approval of the Executive Director of Aviation.
- G. The right for Concessionaire's employees, in common with other employees of tenants of the Terminal Building, to use vehicular parking space provided by City, subject to the payment of reasonable charges therefore, as set by the City.
- H. *Airport Concession Disadvantaged Business Enterprise Program*
 - 1. This agreement is subject to the requirements of the U.S. Department of Transportation's regulations, 49 CFR Parts 23 and 26 related to the airport concession disadvantaged business enterprises (ACDBE) program. The concessionaire or contractor agrees that it will not discriminate against any business owner because of the owner's race, color, national origin, or sex in connection with the award or performance of any concession

agreement, management contract, or subcontract, purchase or lease agreement, or other agreement covered by 49 CFR Part 23.

2. The concessionaire or contractor agrees to include the above statements in any subsequent concession agreement or contract covered by 49 CFR Part 23, that it enters and cause those businesses to similarly include the statements in further agreements.
3. Each year Concessionaire no later than (90) days following end of each Operational Year shall provide to City the following annual ACDBE information: the name and address of each certified ACDBE with which it has done business during the past year, a description of the nature of the services performed by and/or items purchased from each firm named, and the dollar value of each transaction.

SECTION 4 – RESTRICTIONS ON USES AND PRIVILEGES

The Leased Premises shall be used only for the purposes specified in this Agreement. Concessionaire understands and agrees that City has the right to grant up to five additional privileges under separate agreements for in-terminal rental car operations to other companies.

Prohibited Activities at the service bay include:

- A. Concessionaire shall not utilize the service bay for vehicle storage other than vehicles for rent in the process of being serviced.
- B. Concessionaire shall not utilize the service bay for any maintenance or for the storage of damaged vehicles.
- C. Concessionaire shall not allow its customers or the general public to enter the service bay.
- D. Concessionaire shall not permit its employees to vacuum, wash or fuel their personal vehicles or vehicles not part of the Concessionaire's fleet at the service bay or fueling area.

SECTION 5 – PRIVILEGE FEE, RENTS, FEES AND ACCOUNTING RECORDS

Subsection 5.1 Privilege Fee, Rent and Fees.

- A. *Privilege Fee.* As consideration for the privilege of operating the concession hereunder, Concessionaire shall pay to City each contract year, for the full term of this Agreement, a Privilege Fee. Said Privilege Fee shall be the greater of either the guaranteed Minimum Annual Privilege Fee or the Percentage Fee applicable to Gross Revenue, hereinafter defined, as follows:

1. Privilege Fee – the greater of either:
 - a. ten percent (10%) of the Concessionaire’s annual Gross Revenues (“Percentage Privilege Fee”);

OR

- b. the respective yearly amount shown below as the Concessionaire’s Minimum Annual Guaranteed fee (“MAG”):

January 1, 2019 to December 31, 2019	\$	60,000.00
January 1, 2020 to December 31, 2020	\$	60,000.00
January 1, 2021 to December 31, 2021	\$	60,000.00
January 1, 2022 to December 31, 2022	\$	60,000.00
January 1, 2023 to December 31, 2023	\$	60,000.00

2. Monthly payment shall be the greater of 1/12th of the respective year’s MAG or 10% of reported gross revenues for the previous month. The MAG payment shall be paid in advance on the first (1st) day of each month during each Operations Year, until such time as the Concessionaire has paid to the Airport an amount equal to the respective annual MAG identified in Section 5.1(A)(1)(b) above. On or before the 20th of each month the Concessionaire shall provide the Airport with: i) a signed and certified Report of Gross Revenues for the preceding month and ii) payment of any percentage Privilege Fee shown to be due for the preceding month, as designated on Exhibit B, attached hereto and made a part hereof. Once the sum of Privilege Fee payments remitted has reached the MAG in any given Operations Year, the Concessionaire may cease remittance of the 1/12th of the respective year’s MAG on the first (1st) day of each month for the remainder of that Operations Year. The Concessionaire shall continue to report and remit each and every month after the annual MAG has been reached the full 10% of reported gross revenues for the previous month.
3. In the event of a major traffic reduction at GRK, during the term of this Agreement, the MAG hereinabove provided for in this Section 5.1(A) above shall be abated for the period of time the condition exists. A major traffic reduction at GRK shall be defined as a twenty five percent (25%) reduction in the number of passengers deplaning on scheduled airline flights at GRK during any period of three (3) consecutive calendar months as compared to the number of such deplaning passengers in the same calendar months during the preceding calendar year.
4. Concessionaire acknowledges that Privilege Fee payments by Concessionaire to City under this Agreement are for Concessionaire’s privilege to use the Airport facilities and access the Airport market and are not fees imposed by City upon Concessionaire’s customers. City does not require, but will not prohibit, a separate statement of and charge for the Privilege Fee on customer invoices or rental agreements (“Recovery

Fee”), provided that such Recovery Fee meets all of the following conditions: (a) such Recovery Fee must be titled “Concession Recovery Fee,” “Concession Recoupment Fee” or such other name first approved by the Executive Director of Aviation in writing; (b) the Recovery Fee must be shown on the customer rental car agreement and invoiced with other Concessionaire charges (i.e. “above the line”); (c) the Recovery Fee as stated on the invoice and charged to the customer shall be no more than 11.11% of Gross Revenues and shall be specifically included in the Definition of Gross Revenues for purposes of remittance to City; (d) Concessionaire shall neither identify, treat, or refer to the Recovery Fee as a tax, nor imply that City is requiring the pass through of such fee; (e) Concessionaire shall comply with all applicable laws, including Federal Trade Commission requirements, any Texas Consumer Protection legislation and any commitment to or contractual obligation by Concessionaire with any governmental agency or officer with authority over Concessionaire’s activities.

B. Rent -

1. Rent for Premises

Concessionaire shall pay to the City, in advance, on the 1st day of each month, one twelfth the following annual rents or the monthly rent as applicable:

- a) For the period commencing January 1, 2019 through December 31, 2019, Concessionaire shall pay the sum of Twenty-five Dollars and Thirty-two Cents (\$25.32) per square foot per annum for Four Hundred and Forty Four (444) square feet of counter/office/queuing position in the Terminal Building. On January 1 of each year for the period of this Agreement, commencing January 1, 2020, the rental amounts for the counter/office/queuing space, shall be adjusted in accordance with the Consumer Price Index – National Index for All Urban Consumers for the previous calendar year. Said adjustment shall be computed as follows:

$$\begin{aligned} &\text{Most recent year's rate x} \\ &\quad (\text{CPI for November of most recent year} / \\ &\quad \text{CPI for November of the next most recent year}) = \text{New Rate} \end{aligned}$$

- b) For the period commencing January 1, 2019 through December 31, 2019, Concessionaire shall pay the sum of Twenty-five Thousand Nine Hundred and Twenty Dollars (\$25,920), per annum for Ready Return Block “RR-5” as shown on Exhibit A2. On January 1 of each year for the period of this Agreement, commencing January 1, 2020, the rental amounts for the parking block, shall be adjusted in accordance with the Consumer Price Index – National Index for All

Urban Consumers for the previous calendar year, as described above.

- c) For the period commencing January 1, 2019 through December 31, 2019, Concessionaire shall pay the sum of Four Thousand Eight Hundred Dollars (\$4,800), per annum for service bay “3” as shown on Exhibit A2. On January 1 of each year for the period of this Agreement, commencing January 1, 2020, the rental amounts for the service bay, shall be adjusted in accordance with the Consumer Price Index – National Index for All Urban Consumers for the previous calendar year, as described above.
- d) For the period commencing January 1, 2019 through December 31, 2019, Concessionaire shall pay the sum of One Thousand Two Hundred Dollars (\$1,200), per annum for storage area “A” as shown on Exhibit A3. On January 1 of each year for the period of this Agreement, commencing January 1, 2020, the rental amounts for the storage area, shall be adjusted in accordance with the Consumer Price Index – National Index for All Urban Consumers for the previous calendar year, as described above.
- e) If requested by Concessionaire, overflow parking lanes as agreed upon with the Executive Director of Aviation on a month to month basis in the amount of \$150 per lane per month through December 31, 2019. On January 1 of each year for the period of this Agreement, commencing January 1, 2020, the rental amounts for the overflow parking lanes, shall be adjusted in accordance with the Consumer Price Index – National Index for All Urban Consumers for the previous calendar year, as described above. Overflow lanes are shown on Exhibit A4.

C. Additional Fees –

- 1. The Concessionaire shall collect the CFCs on behalf of the Airport and remit to the Airport, in accordance with the City’s CFC resolution, the full amount of the Transaction Day fee collected from each Rental Car customer.
- 2. The Concessionaire shall pay to the City for telephone system/service access to the Internet via a T-1 as follows:

Local service	\$23.50 per line per month
Voice mail	\$4.25 per line per month
Phone rental	\$6.00 per phone per month
Maintenance fee	\$15.50 per line per month

Above telecommunication fees are subject to change as determined by the City. Payment shall be due within thirty (30) days of invoice date.

3. The Concessionaire shall pay to the City a per wash fee of \$2.00 per automated wash. The Concessionaire shall pay to the City, for use of the manual car wash, a rate of \$1.25 per 5 minute session.

Car wash fees are subject to change as determined by the City with advance written notice. Payment shall be due within thirty (30) days of invoice date.

4. The Concessionaire shall pay to the City, based on actual gallons of fuel pumped, a per gallon fuel rate equal to the City's purchase price of the fuel plus \$0.15 cents, as may be adjusted by the City with advance written notice.

Payment shall be due within thirty (30) days of invoice date.

5. If the Concessionaire's bid reflected the operation of two brands in its concession, Concessionaire shall pay to the City a fee of One Thousand Dollars (\$1,000) per month which shall be paid in advance on the first (1st) of each month.
6. Additional fees may include charges for special items or activities including, but not limited to, employee parking, monthly electronic access card fees, badging fees, and disposal of debris left in service bay area and assigned parking areas. The City may assess reasonable, non-discriminatory and cost-recovery based charges for these special items or activities. All new charges will be reviewed with Concessionaire prior to implementation. Other charges payable by Concessionaire, shall be paid by Concessionaire to City no later than thirty (30) days following receipt by Concessionaire of billing therefor.
7. Concessionaire shall be charged, at the current short term parking rate, for any of its vehicles found to be parked in a parking space not specifically leased by the Concessionaire or without the approval of the Executive Director of Aviation.

- D. Any and all payments due to the City by Concessionaire shall be remitted to the following address:

City of Killeen Finance Department
Attn: Accounts Receivable
P.O. Box 1329
Killeen, TX 76540

- E. Year End Adjustments to Privilege Fees, Rents and Fees.

In the event the amount of payments made during the preceding Operations Year exceeds the total of any payments due for such Operations Year, the excess payment shall be credited against the payments for the next Operations Year, except that any excess payment during the final Operations Year of this Agreement will be returned to the Concessionaire within thirty (30) days after the Airport's acceptance of the final Certified Statement described in this Section. Concessionaire shall submit separate system generated reports for each brand name operated.

Subsection 5.2 Statements, Books, and Records; Delinquent Rentals.

- A. Monthly Statements; Books and Records. Within twenty (20) days after the close of each calendar month of the term of this Agreement, Concessionaire shall submit to City, in such detail and on the statement form designated as Exhibit B or as may reasonably be specified by City, certain information, including but not limited to, the number of Transactions executed during the preceding month, the number of Transaction Days Motor Vehicles were rented during the preceding month, and the statement of its Gross Revenues during the preceding month upon which the percentage payments to City set forth in Subsection 5.1 A(1) are to be computed, and said Exhibit B statement to be signed by a responsible accounting officer of Concessionaire. City reserves the right to change the form of the monthly statement and to require the submission by Concessionaire of other information pertaining to the Gross Revenues hereunder, and Concessionaire agrees to change the form of its statements to that requested by City and to provide any such additional information City may reasonably request. Concessionaire shall keep full and accurate books and records showing all of its Gross Revenues hereunder, and City shall have the right, through its representatives and at reasonable times, at its own expense, to inspect, examine, copy and audit such books and records, including State of Texas sales tax return records. Concessionaire hereby agrees that all such books and records will be made available to City for at least three (3) years following the period covered by such books and records.
- B. Annual Certified Statements. Each year during the term of this Agreement, Concessionaire shall provide to City a written statement, certified by an independent Certified Public Accountant, to City stating that in his or her opinion the Percentage Fees paid by Concessionaire to City during the preceding year pursuant to this Agreement were made in accordance with the terms of this Agreement. Said statement shall be submitted by Concessionaire, to be received by City within ninety (90) days of the end of each contract year. Such statement shall also contain a list of the Gross Revenues, by month, as shown on the books and records of Concessionaire and which were used to compute the Percentage Fee payments made to City during the period covered by said statement.
- C. Delinquent Rentals and Fees. Without waiving any other right or action

available to City in the event of default in the payment of charges or fees payable to City, pursuant to this Agreement, a late fee of one and a half percent (1.5%) of the total amount due will be assessed to the Concessionaire if payments prescribed above are not received by the dates prescribed therein. An additional one and a half percent (1.5%) of the outstanding amount will be assessed each month that all or a portion of the Concessionaire's obligations remain unpaid.

Subsection 5.3 Audit. City reserves the right to audit Concessionaire's books and records pertaining to the Leased Premises, at its own expense, at any time for the purpose of verifying the Gross Revenues, Privilege Fee and CFC calculation hereunder for any period three (3) years prior to such audit. If, however, as a result of such audit, it is established that Concessionaire has understated the Gross Revenues received from all operations at the Leased Premises by two percent (2%) or more (after the deductions and exclusions herein), the entire expense of said audit shall be borne by Concessionaire. Any additional Privilege Fee due shall forthwith be paid by Concessionaire to City with interest thereon at one and one-half percent (1.5%) per month from the date such additional Privilege Fee became due.

SECTION 6 – INSTALLATION OF IMPROVEMENTS AND DESIGN, FURNISHING, AND EQUIPPING OF PREMISES

Subsection 6.1 Building Services

- A. City Improvements and Services. City shall initially insure and provide occupancy of the Leased Premises to Concessionaire with said Leased Premises meeting all federal, state and local code requirements for the operation of a rental car concession. City shall provide and maintain, water, sewer, general lighting, electrical power, heating and air-conditioning, and telephone system/service access to the Internet via a T-1 for the Terminal Building. Heating and air conditioning, electrical service, and telephone system/service access to the Internet via T-1 are provided to the Leased Premises only. If Concessionaire requires additional lighting, electrical power, water, or adjustments to the air-conditioning system or telephone system, such additional improvements or services shall be subject to the prior written approval of Executive Director of Aviation, and any such approved improvements or services shall be made at Concessionaire's expense.
- B. Concessionaire's Right to Additional Services. Concessionaire shall have the right, at its own expense, to request and receive additional services or systems, provided that any such services or systems shall require the written approval of Executive Director of Aviation before installation.

Subsection 6.2 Approval of Plans and Specifications; Provision of Drawings.

- A. General. Any improvements to be made to or upon the Leased Premises by Concessionaire, and any subsequent alterations or additions to such improvements, shall be subject to the prior written approval of Executive

- Director of Aviation. Full and complete plans and specifications for all work, facilities, improvements, and finishes, and the time required to complete same, shall be submitted to and receive the written approval of Executive Director of Aviation before any work or construction is commenced, which shall not be unreasonably withheld or delayed. First-class standards of design and construction shall be complied with in connection with all such work, facilities, and improvements; and all construction shall conform to the general architectural requirements of Executive Director of Aviation as established for each improvement program. Two (2) copies of plans for all improvements or subsequent changes therein or alterations thereof shall be given to Executive Director of Aviation for review prior to commencement of construction; after final approval by Executive Director of Aviation, Executive Director of Aviation shall return to Concessionaire one (1) approved copy for Concessionaire's records and shall retain one (1) approved copy as an official record thereof.
- B. Improvements Conform to Statutes, Ordinances, Etc. All improvements, furniture, fixtures, equipment, and finishes, including the plans and specifications therefore, constructed or installed by Concessionaire, its agents, or contractors, shall conform in all respects to applicable statutes, ordinances, building codes, and rules and regulations, and public bidding laws. Any approval given by City shall not constitute a representation or warranty as to such conformity; responsibility therefore shall at all times remain with Concessionaire.
- C. Approvals Extend to Architectural and Aesthetic Matters. Approval of City shall extend to and include architectural and aesthetic matters and City reserves the right to reasonably reject any layout or design proposals submitted and to require Concessionaire to resubmit any such layout or design proposals until they meet Executive Director of Aviation approval.
- D. Disapprovals. In the event of disapproval by City of any portion of any plans or specifications, Concessionaire shall promptly submit necessary modifications and revisions thereof for approval by Executive Director of Aviation. City agrees to act promptly upon such plans and specifications and upon requests for approval of changes or alterations in said plans or specifications. No substantial changes or alterations shall be made in said plans or specifications after initial approval by City, and no alterations or improvements shall be made to or upon the Leased Premises without the prior written approval of Executive Director of Aviation.
- E. Provision of As-Built Drawings. Upon completion of any construction project, Concessionaire shall provide City two (2) completed sets of as-built drawings in reproducible form as specified by City. Concessionaire agrees that, upon the request of City, Concessionaire will inspect the Leased Premises jointly with City to verify the as-built drawings.

SECTION 7 – TITLE TO IMPROVEMENTS, STRUCTURAL ALTERATIONS, ETC.

Subsection 7.1 Title. All improvements made to the Leased Premises by Concessionaire, and any additions and alterations thereto made by Concessionaire, shall be and remain the property of Concessionaire until the termination of this Agreement (whether by expiration of the term, cancellation, forfeiture or otherwise), at which time said improvements, except for Trade Fixtures, personal property, and expendables, shall become the property of City, at no cost to City.

Subsection 7.2 Structural Alterations. Concessionaire shall make no structural alterations to the Leased Premises without the prior written consent of Executive Director of Aviation.

Subsection 7.3 Alterations and Improvements to Airport. Concessionaire acknowledges that from time to time City may undertake construction, repair, or other activities related to the operation, maintenance and repair of the Terminal Building which may temporarily affect Concessionaire's operations hereunder. Concessionaire agrees to accommodate City in such matters, even though Concessionaire's own activities may be inconvenienced, and Concessionaire agrees that no liability shall attach to City, its members, employees, or agents by reason of such inconvenience or impairment. It is agreed that in the event such activities of City substantially impair the operations of Concessionaire under this Agreement, the Minimum Privilege Fee shall be waived during such period of substantial impairment, with what constitutes "substantial impairment" being reasonably determined by Executive Director of Aviation after consultation with Concessionaire. Concessionaire agrees that if relocation is required that Concessionaire shall move its operations as reasonably directed by Executive Director of Aviation.

Subsection 7.4 Removal and Demolition. Concessionaire shall not remove or demolish, in whole or in part, any Leasehold Improvements upon the Leased Premises without the prior written consent of City which may, at its sole discretion, condition such consent upon the obligation of Concessionaire, at Concessionaire's cost, to replace the same by an improvement specified in such consent.

SECTION 8 – MAINTENANCE OF PREMISES

Subsection 8.1 Airport Maintenance Obligations.

- A. General Maintenance and Operation. City agrees that it will, with reasonable diligence, maintain, operate, and keep in good repair the Airport, including the Terminal Building and all appurtenances, facilities, and services now or hereafter connected therewith. Airport shall keep the car rental parking lot and the overflow parking area in suitable repair, and provide general lighting for these areas.
- B. Structural Maintenance. City shall provide, or cause to be provided, structural maintenance of the Terminal Building.

- C. Maintain Access. City shall, throughout the term of this Agreement, maintain all airport-owned roads on the Airport giving access to the Terminal Building in good and adequate condition for use by cars and trucks and shall maintain free and uninterrupted access to the Terminal Building over said road at all times. City reserves the right to reasonably restrict access to the Terminal Building area for automobile deliveries during peak activity periods.
- D. Car Wash. City will maintain and inspect the car wash facilities as recommended by the manufacturer including routine maintenance of the car wash for normal activities, wear and tear. Normal and routine maintenance of roofs, walls, utility infrastructure, building mechanical systems and structural building components will be performed by City. Wash soaps, rinses, brushes, hoses, and utilities will be provided by the City. City has the exclusive authority to stop the use of the car wash for maintenance and inspections as is necessary, at City's sole discretion, without damage or liability to Concessionaire. City will take reasonable action to notify Concessionaire for closure of the car wash.
- E. Telephone System/Service Access to the Internet via a T-1. The Airport shall furnish telephone system/service access to the Internet via a T-1. Rates for these services will be in accordance with Section 5.1(C). A letter of agreement or other suitable document will be executed between the Airport's Executive Director of Aviation or his/her designated representative and the local designated representative of the Concessionaire to document exactly which services are agreed to between the two parties. Airport reserves the right to change or terminate said telephone and/or internet service at some point during the term of this Agreement. Airport will provide at least a ninety (90) day notice to Concessionaire of any service changes and assist in facilitating replacement services via a local communication provider.

Subsection 8.2 Concessionaire's Maintenance Obligations.

- A. Concessionaire's General Obligations. Except for maintenance of the Terminal Building, Car Wash, and Telephone System, as provided in Subsection 8.1, Concessionaire shall be obligated, without cost to City, to maintain the Leased Premises and every part thereof in good appearance, repair, and safe condition. Concessionaire shall maintain and repair all Leasehold Improvements on the Leased Premises and all furnishings, fixtures, and equipment therein, whether installed by Concessionaire or by others, including repainting or redecorating as necessary, and replacing or repairing worn carpet, tile, fixtures, or furnishings. All such maintenance and repairs shall be at least of quality equal to the original in materials and workmanship, and all work, including paint colors, shall be subject to the prior written approval of Executive Director of Aviation. Concessionaire shall be obligated, without cost to City, to provide custodial service to Leased Premises. Concessionaire shall be responsible for the replacement cost of

lost keys and floor finish restoration.

- B. Hazardous Conditions. Upon discovery, Concessionaire shall immediately give oral notice to Airport of any hazardous or potentially hazardous conditions in the Leased Premises or in the Terminal Building. Any hazardous or potentially hazardous condition in the Leased Premises shall be corrected immediately upon receipt of oral notice from the Executive Director of Aviation. At the direction of said Director, Concessionaire shall close the Leased Premises until such hazardous or potentially hazardous condition is removed.
- C. Trash and Refuse. City shall provide, at no cost to Concessionaire, a container for the adequate sanitary handling of all trash and other refuse caused as a result of the operation of the Leased Premises. Concessionaire shall be responsible for disposal of its own trash accumulations by depositing it in the nearest exterior trash dumpster on a daily basis. Concessionaire will regularly inspect exterior areas assigned to them and will remove all trash and debris. Failure to do so will result in the City completing this task and a fee assessed to the Concessionaire for the service. Trash receptacles inside the terminal building are for customer use only. Piling of boxes, cartons, barrels, or other similar items in view of a public area is prohibited. Concessionaire shall keep any areas used for trash and garbage storage prior to removal from Airport in a reasonably clean and orderly condition so as not to unduly attract rodents, pests, or birds, or create an offensive odor. Concessionaire also agrees to participate in the City's recycling program by depositing all recyclable products in the appropriate outside recycling containers in lieu of the trash dumpster.
- D. Transporting Trash and Refuse. In transporting trash and refuse from the Leased Premises, Concessionaire shall ensure that trash is not strewn around while taking refuse to the dump site. Such disposal shall take place during hours as may be approved by the City.
- E. Damage to Equipment. Concessionaire will be responsible for the cost of replacement equipment deemed to be damaged by their employees due to negligence.

SECTION 9 – LIENS, PAYMENT, AND PERFORMANCE BONDS

Subsection 9.1 Construction Surety Bond. Concessionaire shall not allow any liens or encumbrances to be attached to the Leased Premises. Prior to the commencement of any construction or alteration hereunder which exceeds \$10,000 in cost, Concessionaire or its contractor shall furnish to City, and without expense to City, a surety bond, issued by a surety company licensed to transact business in the State of Texas and satisfactory to and approved by City with Concessionaire's contractor or contractors as principals, in a sum not less than one hundred percent (100%) of the total cost of the contract or contracts for the

construction or alteration of the improvements and facilities mentioned herein. Said bond shall guarantee the prompt payment to all persons supplying labor, materials, provisions, supplies, and equipment used directly or indirectly by said contractor, subcontractor(s), and suppliers in the prosecution of the work provided for in said construction contract and shall protect City from any liability, losses, or damages arising there from.

Subsection 9.2 Compliance with Federal Aviation Regulations, 14 CFR Part 139, and Transportation Security Administration security requirements 49 CFR Part 1542. Concessionaire agrees to comply with Federal Aviation Regulations, and 1542 (Airport Security), U.S. Army requirements, and the City's policies as outlined in City's approved Operations Plan and Airport Security Plan. Concessionaire further agrees that any fines levied upon the City or Concessionaire through enforcement of these regulations because of acts by Concessionaire's employees, agents, suppliers, guests, or patrons shall be borne by Concessionaire to the extent said acts contributed to said fines.

Subsection 9.3 Security. During the term of this Agreement, the City shall require the Operator to deliver (and thereafter maintain current for the entire term of this Agreement) an instrument of security in a form satisfactory to the City, in its sole discretion, in the amount of twenty-five percent (25%) of Concessionaire's Minimum Annual Guarantee for each year hereunder, in order to secure the performance of all of Concessionaire's obligations under this Agreement, including without limitation, the payment of all the percentages, minimums, fees, charges and costs set out herein. Said security may be in the form of a bond.

SECTION 10 – OPERATION OF LEASED PREMISES: HOURS AND DELIVERIES

Subsection 10.1 Hours of Operation. Concessionaire shall actively operate in the Leased Premises and shall use a business-like operation therein. The Concessionaire shall be open to serve the public seven (7) days per week and hours of operation shall be such that passengers of flights arriving or departing from the terminal will be accommodated. In no event shall the hours of operation be curtailed to an extent that the service contemplated under this Agreement shall be diminished. Except as otherwise stated herein, the hours of service shall be determined in light of changing public demands and airline operating schedules. Concessionaire may advise the Executive Director of Aviation of Concessionaire's analysis of the optimum arrangements, but the final determination shall be made by the Executive Director of Aviation based on their analysis of necessary service to the public.

Subsection 10.2 Delivery of Goods. Concessionaire shall arrange for the timely delivery of all motor vehicles and supplies, at such times, in such locations(s), and by such routes as determined by City. Concessionaire shall abide by all Transportation Security Administration (TSA) requirements for parking of motor vehicles near the terminal building.

Subsection 10.3 Utilities.

- A. City shall provide the Leased Premises with heat and air-conditioning to keep the Leased Premises at reasonable temperatures for the conduct of Concessionaire's activities. City shall have the right to set, monitor, adjust and restrict thermostat settings to levels it determines to be appropriate.
- B. City shall provide electricity to the Leased Premises by means of wiring installations, and Concessionaire shall make such connections as required and permitted by building code. At no time shall Concessionaire's use of electric current exceed the capacity of the wiring installation in place.

SECTION 11 – QUALITY AND CHARACTER OF SERVICE

Subsection 11.1 Type of Operation. Concessionaire shall maintain and operate the concession privileges granted hereunder in an orderly, proper, and first-class manner, which, in the sole judgment of Executive Director of Aviation, does not unduly annoy, disturb, or offend others at the Airport.

Subsection 11.2 Services to the General Public. Concessionaire understands and agrees that its operation at the Airport necessitates the rendering of public services such as giving directions, and generally assisting the public.

Subsection 11.3 Additional Compliance. Concessionaire shall comply with all applicable governmental laws, ordinances, and regulations in the conduct of its operations under this Agreement.

Subsection 11.4 Personnel.

- A. General. Concessionaire shall maintain a sufficient number of properly trained personnel to ensure that all customers of Concessionaire receive prompt and courteous service. All such personnel, while on or about the Leased Premises, shall be polite, clean, appropriately attired, and neat in appearance. Clothing will be neat and clean and present a professional appearance. Executive Director of Aviation shall have the right to object to the demeanor, conduct, and appearance of any employee of Concessionaire, or any of its invitees or those doing business with it, whereupon Concessionaire shall take all steps necessary to remedy the cause of the objection. Concessionaire will ensure that its counter is staffed at all times during the posted hours of operation.
- B. Manager. The management, maintenance, and operation of the Leased Premises and the concession conducted thereon shall be at all times during the term hereof under the supervision and direction of an active, qualified, competent, and experienced manager, who shall at all times be authorized to represent and act for Concessionaire. Concessionaire shall cause such manager to be available during normal business hours, and Concessionaire

will at all times during the absence of such manager assign, or cause to be assigned, a qualified subordinate to assume and be directly responsible for the carrying out of his or her duties.

SECTION 12 – NON-DISCRIMINATION

This agreement is subject to the requirements of the U.S. Department of Transportation's regulations, 49 CFR Part 23, pursuant to law, it is unlawful and Concessionaire agrees not to willfully refuse to employ, to discharge, or to discriminate against any person otherwise qualified because of race, color, religion, sex, sexual orientation, age, disability, national origin or ancestry, lawful source of income, marital status, creed, or familial status; not to discriminate for the same reason in regard to tenure, terms, or conditions of employment, not to deny promotion or increase in compensation solely for these reasons; not to adopt or enforce any employment policy which discriminates between employees on account of race, color, religion, sex, creed, age, disability, national origin or ancestry, lawful source of income, marital status or familial status; not to seek such information as to any employee as a condition of employment; not to penalize any employee or discriminate in the selection of personnel for training, solely on the basis of race, color, religion, sex, sexual orientation, age, disability, national origin or ancestry, lawful source of income, marital status, creed or familial status.

Concessionaire shall include or cause to be included in each subcontract covering any of the services to be performed under this Agreement a provision similar to the above paragraph, together with a clause requiring such insertion in further subcontracts that may in turn be made.

SECTION 13 – IDEMNIFICATION AND INSURANCE

Subsection 13.1 Indemnification. To the fullest extent allowable by law, Concessionaire hereby indemnifies and shall defend and hold harmless, at Concessionaire's expense, City, its elected and appointed officials, committee members, officers, employees or authorized representatives or volunteers, from and against any and all suits, actions, legal or administrative proceedings, claims, demands, damages, liabilities, losses, interest, attorney's fees (including in-house counsel legal fees), costs and expenses of whatsoever kind, character or nature whether arising before, during, or after completion of the Agreement hereunder and in any manner directly or indirectly caused or contributed to in whole or in part, by reason of any act, omission, fault, or negligence, whether active or passive of Concessionaire, or of anyone acting under its direction or control or on its behalf in connection with or incident to the performance of this Agreement, regardless if liability without fault is sought to be imposed on City. Concessionaire's aforesaid indemnity and hold harmless agreement shall not be applicable to any liability caused by the negligent or willful misconduct of City, its elected and appointed officials, officers, employees or authorized representatives or volunteers. Nothing in this Agreement shall be construed as City waiving its statutory limitation and/or immunities as set forth in the applicable Texas Statutes or other applicable law. This indemnity provision shall survive the termination

or expiration of this Agreement.

Concessionaire shall reimburse City, its elected and appointed officials, officers, employees or authorized representatives or volunteers for any and all legal expenses and costs incurred by each of them in connection therewith or in enforcing the indemnity herein provided. Concessionaire's obligation to indemnify shall not be restricted to insurance proceeds, if any, received by City, its elected and appointed officials, officers, employees or authorized representatives or volunteers.

To the extent allowed by law, except for damage or injury caused by the willful or negligent act or omission of Concessionaire, its agents or employees, City shall indemnify, defend and save Concessionaire, its agents, representatives, and employees from any and all lawsuits, claims, loss and damages of any nature whatsoever, including damage to property of any Concessionaire and the injury, including death, of employees, agents, or customers of Concessionaire, arising either directly or indirectly out of any operations of the City hereunder, except lawsuits, claims, loss and damages arising out of the sole negligence of the Concessionaire, their employees, or agents.

Subsection 13.2 Concessionaire to Provide General Liability and Automobile Insurance. Concessionaire shall, at its sole expense, obtain and maintain in effect at all times during this Agreement the following insurance coverage:

- A. Commercial General Liability Insurance of not less than \$5,000,000 per occurrence for bodily injury, personal injury and property damage;
- B. Automobile Insurance of not less than \$5,000,000 per occurrence;
- C. To the extent that Concessionaire employs any employees or as otherwise required by law, Workers' Compensation and Employers' Liability Insurance with Texas statutory limits.

Subsection 13.3 Concessionaire to Provide Property and Fire Insurance. Concessionaire, at its own expense, shall insure all Leasehold Improvements and furnishings, fixtures and equipment for fire, extended coverage, vandalism, and malicious mischief. Such insurance shall be in an amount equal to the full insurable replacement value of such improvements. All property insurance policies shall contain loss payable endorsements in favor of the parties as their respective interests may appear hereunder and shall contain a waiver of subrogation provision in favor of the City. Concessionaire and City agree that any payments received by either from such insuring companies by reason of loss under such policy or policies shall be applied toward repair and reconstruction of said Leasehold Improvements and repair or replacement of leasehold improvements, furnishings, fixtures and equipment.

Subsection 13.4 Both Concessionaire and City to Carry Fire Insurance. It is understood that both Concessionaire and City carry insurance in the form of fire, extended coverage, vandalism, and malicious mischief (hereinafter called "Insurance Coverage") on the leased structural part of the premises, permanent improvements and

loss of income, (in the case of City) and on Leasehold Improvements, furniture, furnishings, equipment, inventory and loss of income, (in the case of Concessionaire), and said Insurance Coverage authorizes a waiver of subrogation between City and Concessionaire, and the parties wish to enter into such waiver of subrogation to the extent of the said Insurance Coverage; therefore, to the extent that City collects under its Insurance Coverage, City waives any and all claims against Concessionaire, its agents, servants, and employees, for loss or damage to City's property resulting from risks included in said Insurance Coverage; and, to the extent that Concessionaire collects under its Insurance Coverage, Concessionaire waives any and all claims against City, its agents, servants, and employees, for loss or damage to Concessionaire's property resulting from risks included in said Insurance Coverage. If this waiver by the parties shall render fully any such insurance policy or shall result in the denial of coverage for a party under such policy, then the provision paragraph shall be deemed to be null and void.

Subsection 13.5 Insurance Certificate. A certificate evidencing insurance required by Subsection 13.2 and 13.3, and listing the City of Killeen as additional insured, excluding Workers' Compensation and Property and Fire Insurance, shall be filed with City prior to the commencement of construction, furnishing and equipping of Leasehold Improvements by Concessionaire upon the Leased Premises, and such certificate shall provide that such Insurance Coverage will not be canceled or reduced without at least thirty (30) days prior written notice to City. Prior to the expiration of any such policy, a certificate showing that such Insurance Coverage has been renewed shall be filed with City. If such Insurance Coverage is canceled or reduced, Concessionaire shall within fifteen (15) days after receipt of written notice from City of such cancellation or reduction in coverage, file with City a certificate showing that the required insurance has been reinstated or provided through another insurance company or companies.

Subsection 13.6 Concessionaire Failure to Provide Certificates. In the event that Concessionaire shall at any time fail to furnish City with the certificate or certificates required under this Section, City, upon written notice to Concessionaire of its intention so to do, shall have the right to obtain the required insurance, at the cost and expense of Concessionaire, and Concessionaire agrees to promptly reimburse City for the cost thereof, plus fifteen percent (15%) thereof for administrative overhead.

SECTION 14 – DAMAGE OR DESTRUCTION OF LEASED PREMISES

Subsection 14.1 Partial Damage. If all or a portion of the Leased Premises is partially damaged by fire, explosion, the elements, public enemy, or other casualty, but not rendered untenable, the same will be repaired with due diligence by City subject to the limitations of Subsection 14.4; provided, however, to the extent that such damage or destruction is not covered by insurance, Concessionaire shall be responsible for reimbursing City for the cost and expenses insured in such repair to the extent that the damage is caused by the negligent act or omission of Concessionaire, its sublessees, agents, or employees.

Subsection 14.2 Extensive Damage. If the damages referred to in Subsection 14.1 shall be so extensive as to render the Terminal Building Premises untenable, but capable of being repaired in thirty (30) days, the same shall be repaired with due diligence by City subject to the limitations of Subsection 14.4; and the charges payable herein for the MAG and Rent under Section 5.1 shall abate from the time of such damage or destruction until such time as the said Leased Premises are fully restored and certified by City's Engineers as ready for occupancy; provided, however, the said fees and charges will not abate and to the extent that such damage or destruction is not covered by insurance, Concessionaire shall be responsible for reimbursing City for the cost and expenses incurred in such repair to the extent that the damage is caused by the negligent act or omission of Concessionaire, its sublessees, agents, or employees.

Subsection 14.3 Complete Destruction. In the event the Terminal Building Premises are completely destroyed by fire, explosion, the elements, the public enemy, or other casualty, or so damaged that they are untenable and cannot be replaced for more than thirty (30) days, City shall undertake the repair, replacement, and reconstruction of said Leased Premises; and charges payable herein for the MAG and Rent under Section 5.1, shall abate as of the time of such damage or destruction until such time as the said Premises are fully restored and certified by City's Executive Director of Aviation as ready for occupancy; provided, however, the said fees and charges will not abate and to the extent that such damage or destruction is not covered by insurance, Concessionaire shall be responsible for reimbursing City for the costs and expenses incurred in said repair to the extent that the damage is caused by the negligent act or omission of Concessionaire, its sublessees, agents, or employees; provided further, however, if within twelve (12) months after the time of such damage or destruction said Leased Premises shall not have been repaired or reconstructed, Concessionaire may cancel this Agreement in its entirety. Rents payable for the leased areas in the Terminal Building and/or Ready/Return Block will only abate if the City is unable to provide alternative space for Concessionaire to conduct its business.

Subsection 14.4 Limits of City's Obligations Defined. It is understood that, in the application of the foregoing Subsections, City's obligations shall be limited to repair or reconstruction of the Leased Premises to the same extent and of equal quality as obtained at the commencement of operations hereunder, subject to funding and appropriation. Redecoration and replacement of furniture, fixtures, equipment, and supplies shall be the responsibility of Concessionaire and any such redecoration and refurnishing/re-equipping shall be of equivalent quality to that originally installed hereunder.

SECTION 15 – CANCELLATION

Subsection 15.1 Cancellation by Concessionaire. Concessionaire may cancel this Agreement and terminate all its obligations hereunder upon or after the happening of one or more of the following events and provided that Concessionaire is not in default in the payment of any fees or charges to City:

- A. The abandonment of the Airport as an airline terminal or the removal of all

certificated passenger airline service from the Airport for a period of no less than thirty (30) consecutive days.

- B. The inability of Concessionaire to use the Airport for a period of longer than ninety (90) days, because of the issuance of any order, rule, or regulation by any competent governmental authority or court having jurisdiction over Concessionaire or City, preventing Concessionaire from operating its business; provided, however, that such inability or such order, rule, or regulation is not primarily due to any fault of Concessionaire.
- C. The material breach by City in the performance of any covenant or agreement herein required to be performed by City and the failure of City to remedy such breach for a period of sixty (60) days after receipt from Concessionaire of written notice to remedy the same.

Subsection 15.2 Cancellation by City. City may cancel this Agreement and terminate all of its obligations hereunder at any time that City is not in default, upon or after the happening of any of the following events:

- A. Concessionaire shall file a voluntary petition in bankruptcy; or
- B. Proceedings in bankruptcy shall be instituted against Concessionaire and Concessionaire is thereafter adjudicated bankrupt pursuant to such proceedings; or
- C. A court shall take jurisdiction of Concessionaire and its assets pursuant to proceedings brought under the provisions of any federal reorganization act; or
- D. A receiver of Concessionaire's assets shall be appointed; or
- E. Concessionaire voluntarily abandons its conduct of its business at the Airport for a period of thirty (30) days, except if such is due to a labor strike or labor dispute in which Concessionaire is involved; or
- F. Any assignment is made by Concessionaire for the benefit of its creditors; or
- G. The material breach by Concessionaire of any of the covenants or agreements herein contained and the failure of Concessionaire to remedy such breach as hereinafter provided. In this regard it is understood that nonpayment of fees or charges hereunder is a material breach. In the event of such material breach, City shall give to Concessionaire notice in writing to correct such breach and if such breach shall continue for fifteen (15) days after the receipt of such notice by Concessionaire, City may, after the lapse of said fifteen (15) day period, cancel this Agreement, without forfeiture, waiver, or release of City's rights to any sum of money due or to become due under the provisions of this Agreement.

- H. The lawful assumption by the United States Government, or any authorized agency thereof, of the operation, control or use of the Airport and facilities, or any substantial part or parts thereof, in such manner as to substantially restrict Concessionaire, for a period of at least thirty (30) days, from its Airport operation.

Subsection 15.3 Termination. Should an early termination of this Agreement occur pursuant to the terms of Subsection 15.2 hereof, City shall have the right to re-enter the Leased Premises, make repairs as necessary, and enter into another agreement for the Leased Premises and privileges, or any part thereof, for the remainder of the term hereof.

Subsection 15.4 Notice of Termination. If any of the events enumerated in Subsections 15.1 and 15.2 shall occur and after due notice the defaulting party has failed to cure or correct same, the complaining party may, at any time thereafter during the continuance of said default, terminate this Agreement by notice in writing, such cancellation and termination to be effective upon the date specified in such notice.

SECTION 16 – NONWAIVER OF RIGHTS

Continued performance by either party hereto pursuant to the terms of this Agreement after a default of any of the terms, covenants, and conditions herein contained to be performed, kept, or observed by the other party hereto shall not be deemed a waiver of any right to cancel this Agreement for any subsequent default; and no waiver of any such default shall be construed or act as a waiver of any subsequent default.

SECTION 17 – SURRENDER OF POSSESSION

Concessionaire shall, upon termination of this Agreement or cancellation, quit and deliver up the Leased Premises and privileges to City peaceably and quietly, with the Leased Premises being in as good order and condition as the same now are or may be hereafter improved by Concessionaire or City, reasonable use and wear thereof excepted. In addition to any lien provided by Texas law, City shall have a specific lien on all property of Concessionaire, and related equipment on the Leased Premises as security for nonpayment. Concessionaire shall have the right to remove all of its trade fixtures and equipment installed or placed by it at its own expense, in, on or about the Premises; subject however, to any valid lien which City may have thereon for unpaid charges or fees. Provided however, the City will not claim or have a lien of any kind, be it contractual or statutory, on or against Concessionaire's motor vehicles for non-payment of any rent or fees due under the Agreement, or for any default of Concessionaire or any other reason, and the City hereby waives all such liens available to the City.

SECTION 18 – TAXES AND LICENSES

Concessionaire shall obtain and pay for all licenses or permits necessary or required by law for the construction of improvements, the installation of equipment and furnishings,

and any other licenses necessary for the conduct of its operations hereunder.

SECTION 19 – INSPECTION OF PREMISES

City or its duly authorized representatives, or agents, and other persons for it, may enter upon said Leased Premises at any and all reasonable times during the term of this Agreement for the purpose and conditions hereof or for any other purpose incidental to rights of City.

SECTION 20 – HOLDING OVER

Should Concessionaire holdover said Leased Premises after this Agreement has terminated in any manner, Concessionaire shall continue such holding over only at sufferance to City. In the event of such holding over, Concessionaire shall pay to the City the amounts specified in Subsection 5.1, the amounts being the amounts in effect immediately prior to the commencement of such holdover.” All other terms and conditions in such holdover shall be the same as herein provided.

SECTION 21 – QUIET ENJOYMENT

City agrees that Concessionaire, upon payment of the fees and charges and all other payments to be paid by Concessionaire under the terms of this Agreement, and upon observing and keeping the agreements and covenants of this Agreement on the part of Concessionaire to be observed and kept, shall lawfully and quietly hold, occupy, and enjoy the Leased Premises during the term of this Agreement.

SECTION 22 – NO LIENS

Concessionaire shall pay for all labor done or materials furnished in the repair, replacement, development, or improvement of the Premises by Concessionaire, and shall keep said Leased Premises and Concessionaire's possessory interest therein free and clear of any lien or encumbrance of any kind whatsoever created by Concessionaire's act or omission.

SECTION 23 – SECURITY AGREEMENTS

City shall provide, or cause to be provided, during the term of this Agreement, all proper and appropriate public fire and police protection similar to that afforded to other Landside tenants or licensees at the Airport, and it will issue and enforce rules and regulations with respect thereto for all portions of the Airport. Concessionaire shall comply with the Airport Security Plan and shall have the right, but shall not be obligated, to provide such additional or supplemental public protection as it may desire, but such right, whether or not exercised by Concessionaire, shall not in any way be construed to limit or reduce the obligations of City hereunder.

SECTION 24 – AGREEMENT SUBORDINATE TO AGREEMENTS WITH THE UNITED STATES

This Agreement is subject and subordinate to the terms, reservations, restrictions, and conditions of any existing or future agreements between the City and the United States, the execution of which has been or may be required as a condition precedent to the transfer of federal rights or property to the City for Airport purposes, and the expenditure of federal funds for the extension, expansion, or development of the Killeen - Fort Hood Regional Airport. Should the effect of such Agreement with the United States government be to take any of the property under lease or substantially destroy the commercial value of such improvements, City shall terminate this Agreement.

SECTION 25 – RIGHTS AND PRIVILEGES OF CITY

- A. City shall have the right to enforce, and adopt from time to time, reasonable rules and regulations, which Concessionaire agrees to observe and obey, with respect to the use of the Airport, Airport Terminal Building and appurtenances, provided that such rules and regulations shall not be inconsistent with safety, current rules and regulations of the FAA, and any future changes prescribed from time to time by the FAA.
- B. The City Manager or designee is hereby designated as its official representative for the enforcement of all provisions in this Agreement with full power to represent City with dealings with Concessionaire in connection with the rights herein granted.
- C. All actions relating to policy determination, modification of this Agreement, termination of this contract, and any similar matters affecting the terms of this Agreement shall emanate from the City Council, their successors or assigns.
- D. The Executive Director of Aviation or designee may enter upon the Leased Premises, now or hereafter leased to Concessionaire hereunder, at any reasonable time, for any purpose necessary, incidental to, or connected with, the performance of its obligations hereunder, or in the exercise of its governmental functions.
- E. City reserves the right to further plan, develop, improve, remodel and/or reconfigure the Airport, including the Leased Premises and existing vehicle and pedestrian traffic patterns, as the City deems appropriate, regardless of the desires or views of Concessionaire, and without interference or hindrance.
- F. City hereby reserves for the use and benefit of the public, the right of aircraft to fly in the airspace overlying the land herein leased, together with the right of said aircraft to cause such noise as may be inherent in the operation of aircraft landing at, taking off from, or operating on or in the vicinity of Killeen - Fort Hood Regional Airport, and the right to pursue all operations of the Killeen - Fort Hood Regional Airport.

- G. City reserves the right to take any action it considers necessary to protect the aerial approaches of the Airport against obstruction, together with the right to prevent Concessionaire from erecting, or permitting to be erected, any building or other structure on the Airport, which, in the opinion of the City, would limit the usefulness of the Airport, or constitute a hazard to aircraft.
- H. City may from time to time increase the size or capacity of any such Public Aircraft Facilities or Passenger Terminal Building or Common Use Portion of the Airport or make alterations thereto or reconstruct or relocate them or modify the design and type of construction thereof or close them or any portions of them, either temporarily or permanently, provided notice is given to Concessionaire.
- I. This Agreement at any time may be reopened for renegotiation if Federal Aviation Administration (FAA) Airport Certification (FAR Part 139), Transportation Security Administration (TSA) Security Requirements (49 CFR, Part 1542), or U.S. Army regulations result in major expenditures to City due to Concessionaire's tenancy on the Killeen - Fort Hood Regional Airport. If said renegotiation is desired, written notice must be given to Concessionaire sixty (60) days prior to such renegotiations.
- J. City reserves the right to relocate the Leased Premises upon the completion of any Terminal area remodeling or expansion. City will not be liable for the costs associated with the moving or reinstallation of Concessionaire's equipment. In the event the City requires a move by the Concessionaire, the City will reimburse actual out-of-pocket costs associated with the relocation as approved in advance subject to a maximum amount as established by the City.

SECTION 26 – ACCESS CONTROL

- A. Concessionaire shall upon termination of this agreement return all issued keys and access cards to City. If all issued keys and access cards are not returned to City at the termination of this Agreement Concessionaire shall pay to City cost to re-core premises locks and cut new keys at the rate set at the time of such re-core and to pay for any lost access cards.
- B. Concessionaire is responsible for all keys and access cards issued to employees of Concessionaire. Concessionaire is responsible to insure every employee that has regular duty at the Airport is submitted for airport electronic access cards appropriate for that employee and that all employee data remains current. The Concessionaire will notify the appropriate representative of the Airport by telephone or other appropriate means as soon as possible following the termination of any employee, but will do so in writing no later than the end of the next working day after the employee's last day of employment at the Airport. The Concessionaire is further responsible for

returning the employee's electronic access cards no later than three (3) working days after the last day of employment at the Airport. Any lost electronic access cards must be reported in writing to the Airport's representative as soon as possible, but no later than the end of the next working day from the date of the loss. Concessionaire is responsible for any charges or damages incurred by the use of electronic access cards issued to its employees unless more than 24 hours (excluding weekends and City of Killeen recognized holidays) have passed from the time the Concessionaire provides written notification to the Airport's representative to cancel any access these electronic access cards allow. A monthly fee will be charged for active employee electronic access cards and for lost cards at the current rates adopted by the City.

- C. Concessionaire may not install additional locks or change locks to Leased Premises without the written approval of the Executive Director of Aviation.

SECTION 27 – NO PERSONAL LIABILITY

Under no circumstances shall any trustee, officer, official, commissioner, Director, member, partner or employee of City have any personal liability arising out of this Agreement, and Concessionaire shall not seek or claim any such personal liability.

SECTION 28 – GOVERNING LAW

This Agreement and all questions and issues arising in connection herewith shall be governed by and construed in accordance with the laws of the State of Texas. Venue for any action arising out of or in any way related to this Agreement shall be exclusively in Bell County, Texas. Each party waives its right to challenge venue.

SECTION 29 – NOTIFICATION

Concessionaire shall:

- A. As soon as possible and in any event within a reasonable period of time after the occurrence of any default, notify City in writing of such default and set forth the details thereof and the action which is being taken or proposed to be taken by Concessionaire with respect thereto.
- B. Promptly notify City of the commencement of any litigation or administrative proceeding that would cause any representation and warranty of Concessionaire contained in this Agreement to be untrue.
- C. Notify City, and provide copies, immediately, upon receipt, of any notice, pleading, citation, indictment, complaint, order or decree from any federal, state or local government agency or regulatory body, asserting or alleging a circumstance or condition that requires or may require a financial contribution by Concessionaire or any guarantor or an investigation, clean-up, removal,

remedial action or other response by or on the part of Concessionaire or any guarantor under any environmental laws, rules, regulations, ordinances or which seeks damages or civil, criminal or punitive penalties from or against Concessionaire or any guarantor for an alleged violation of any environmental laws, rules, regulations or ordinances.

SECTION 30 – SEVERABILITY

The provisions of this Agreement are severable. If any provision or part of this Agreement or the application thereof to any person or circumstance shall be held by a court of competent jurisdiction to be invalid or unconstitutional for any reason, the remainder of this Agreement and the application of such provision or part thereof to other persons or circumstances shall not be affected thereby.

SECTION 31 – ASSIGNMENT, SUBLET, AND TRANSFER

Concessionaire shall not assign, sublet, or transfer its interests or obligations under the provisions of this Agreement without the prior written consent of City, which shall not be unreasonably withheld or delayed. This Agreement shall be binding on the heirs, successors, and assigns of each party hereto. Concessionaire shall provide not less than forty-five (45) days advance written notice of any intended assignment, sublet or transfer.

SECTION 32 – NO WAIVER

The failure of any party to insist, in any one or more instance, upon performance of any of the terms, covenants, or conditions of this Agreement shall not be construed as a waiver, or relinquishment of the future performance of any such term, covenant, or condition by any other party hereto but the obligation of such other party with respect to such future performance shall continue in full force and effect.

SECTION 33 – CONFLICTS OF INTEREST

Concessionaire covenants that it presently has no interest and shall not acquire any interest, direct or indirect, which would conflict in any manner or degree with the performance of its services hereunder. Concessionaire further covenants that in the performance of this Agreement no person having any conflicting interest shall be employed. Any interest on the part of Concessionaire or its employee must be disclosed to City.

SECTION 34 – POLITICAL ACTIVITIES

Concessionaire shall not engage in any political activities while in performance of any and all services and work under this Agreement.

SECTION 35 – ENTIRE AND SUPERSEDING AGREEMENT

This writing, all Exhibits hereto, and the other documents and agreements referenced herein, constitute the entire Agreement between the parties with respect to the subject matter hereof, and all prior agreements, correspondences, discussions and understandings of the parties (whether written or oral) are merged herein and made a part hereof. This Agreement, however, shall be deemed and read to include and incorporate such minutes, approvals, plans, and specifications, as referenced in this Agreement, and in the event of a conflict between this Agreement and any action of City, granting approvals or conditions attendant with such approval, the specific action of City shall be deemed controlling.

SECTION 36 – AMENDMENT

This Agreement shall be amended only by formal written supplementary amendment. No oral amendment of this Agreement shall be given any effect. All amendments to this Agreement shall be in writing executed by both parties.

SECTION 37 – TIME COMPUTATION

Any period of time described in this Agreement by reference to a number of days includes Saturdays, Sundays, and any state or national holidays. Any period of time described in this Agreement by reference to a number of business days does not include Saturdays, Sundays or any state or national holidays. If the date or last date to perform any act or to give any notices is a Saturday, Sunday or state or national holiday, that act or notice may be timely performed or given on the next succeeding day which is not a Saturday, Sunday or state or national holiday.

SECTION 38 – NOTICES

NOTICES. Any notice, demand, certificate or other communication under this Agreement shall be given in writing and deemed effective: a) when personally delivered; b) three (3) days after deposit within the United States Postal Service, postage prepaid, certified, return receipt requested; or c) one (1) business day after deposit with a nationally recognized overnight courier service, addressed by name and to the party or person intended as follows:

To the City: Killeen - Fort Hood Regional Airport
Attn: Executive Director of Aviation
8101 S. Clear Creek Rd, Box C
Killeen, TX 76549

Copy to: Attn. City Attorney
City of Killeen
101 N. College St., 1st Floor
Killeen, TX 76541

To the Concessionaire:

Clearwater Transportation, Ltd. d/b/a Dollar/Thrifty Car Rental
6013 Fountainwood
San Antonio, TX 78233

The parties may designate other addresses from time to time in writing. Concessionaire must provide a valid new address for notices within ten (10) days if the above address becomes invalid.

SECTION 39 – CONSTRUCTION

This Agreement shall be construed without regard to any presumption or rule requiring construction against the party causing such instrument to be drafted. This Agreement shall be deemed to have been drafted by the parties of equal bargaining strength. The captions appearing at the first of each numbered section of this Agreement are inserted and included solely for convenience but shall never be considered or given any effect in construing this Agreement with the duties, obligations, or liabilities of the respective parties hereto or in ascertaining intent, if any questions of intent should arise. All terms and words used in this Agreement, whether singular or plural and regardless of the gender thereof, shall be deemed to include any other number and any other gender as the context may require.

SECTION 40 – NO THIRD PARTY BENEFICIARY

Nothing contained in this Agreement, nor the performance of the parties hereunder, is intended to benefit, nor shall inure to the benefit of, any third party.

SECTION 41 – COMPLIANCE WITH LAW

The parties shall comply in all material respects with any and all applicable federal, state and local laws, regulations and ordinances.

SECTION 42 – FORCE MAJEURE

City shall not be responsible to Concessionaire and Concessionaire shall not be responsible to City for any resulting losses and it shall not be a default hereunder if the fulfillment of any of the terms of this Agreement is delayed or prevented by revolutions or other civil disorders, wars, acts of enemies, strikes, fires, floods, acts of God, adverse weather conditions, legally required environmental remedial actions, industry-wide shortage of materials, or by any other cause not within the control of the party whose performance was interfered with, and which exercise of reasonable diligence, such party is unable to prevent, whether of the class of causes hereinabove enumerated or not, and the time for performance shall be extended by the period of delay occasioned by any such cause.

SECTION 43 – GOOD STANDING

Concessionaire affirms that it is a company duly formed and validly existing and in good standing under the laws of the State of Texas and has the power and all necessary licenses, permits and franchises to own its assets and properties and to carry on its business. Concessionaire is duly licensed or qualified to do business and is in good standing in the State of Texas and in all other jurisdictions in which failure to do so

would have a material adverse effect on its business or financial condition.

SECTION 44 – INDEPENDENT CONTRACTORS

The parties, their employees, agents, volunteers, and representative shall be deemed independent contractors of each other and shall in no way be deemed as a result of this Agreement to be employees of the other. The parties, their employees, agents, volunteers, and representatives are not entitled to any of the benefits that the other provides for its employees. The parties shall not be considered joint agents, joint venturers, or partners.

SECTION 45 – GOVERNMENTAL APPROVALS

Concessionaire acknowledges that various of the specific undertakings of City described in this Agreement may require approvals from the City of Killeen City Council, City of Killeen bodies, and/or other public bodies, some of which may require public hearings and other legal proceedings as conditions precedent thereto. Concessionaire further acknowledges that this Agreement is subject to appropriation by the Killeen City Council. City's obligation to perform under this Agreement is conditioned upon obtaining all such approvals in the manner required by law. City cannot assure that all such approvals will be obtained, however, it agrees to use good faith efforts to obtain such approvals on a timely basis.

SECTION 46 – AUTHORITY

The persons signing this Agreement warrant that they have the authority to sign as, or on behalf of, the party for whom they are signing.

SECTION 47 – COUNTERPARTS

This Agreement may be executed in one or more counterparts, all of which shall be considered but one and the same agreements and shall become effective when one or more counterparts have been signed by each of the parties and delivered to the other party.

SECTION 48 – SURVIVAL

All express representations, indemnifications and limitations of liability included in this Agreement will survive its completion or termination for any reason.

SECTION 49 – MORE FAVORABLE TERMS

In the event the City shall enter into any lease or agreement with any other rental car operator within the Airline Terminal building, that agreement will not contain more favorable terms than this Agreement, unless the same rights, privileges, and more favorable terms are concurrently made available to Concessionaire.

SECTION 50 – ENVIRONMENTAL

Subsection 50.1 Disposal, Use and Storage of Hazardous Materials. Disposal of Hazardous Materials on the Airport is strictly prohibited. Storage and use of Hazardous Materials on the Airport is prohibited, except:

- A. Concessionaire may store and use Hazardous Materials on the Leased Premises in a safe and prudent manner and in accordance with the requirements of all applicable Environmental Laws but only for those kinds and quantities of Hazardous Materials that are normally used in conducting the activities permitted under this Agreement. Storage shall be in an approved Hazardous Materials cabinet or storage container. Concessionaire shall provide Executive Director of Aviation with a copy of any application for a permit for use or storage of Hazardous Materials on the Leased Premises from any regulatory agency responsible for enforcement of Environmental Laws, and shall also a copy of any permit received from such agency; and
- B. Concessionaire may use Hazardous Materials on the Airport other than the Leased Premises only in a safe and prudent manner and in accordance with the requirements of all applicable Environmental Laws but only for those kinds and quantities of Hazardous Materials which are commonly used in conducting the activities permitted under this Agreement.

Subsection 50.2 Liability. Concessionaire shall be solely and fully responsible and liable for:

- A. Storage, use or disposal of Hazardous Materials on the Leased Premises or the Airport, by Concessionaire, Concessionaire's officers, agents, employees, or contractors,
- B. Any Hazardous Material release which is caused by or results from the activities of Concessionaire, Concessionaire's officers, agents, employees, or contractors on the Leased Premises or the Airport.

Subsection 50.3 Prevention of Release. Concessionaire shall take all necessary precautions to prevent its activities from causing any Hazardous Material release to occur on the Leased Premises or the Airport, including, but not limited to any release into soil, groundwater, or City's sewage or storm drainage system.

Subsection 50.4 Obligation to Investigate and Remediate. Concessionaire, at Concessionaire's sole cost and expense, shall promptly investigate and remediate, in accordance with requirements of all applicable Environmental Laws:

- A. Any release or threat of release of Hazardous Material on the Leased Premises or the Airport, including, but not limited to, into soil or groundwater, or City's sewage or storm drainage system which was caused or results in whole or in part from the activities of Concessionaire, Concessionaire's

officers, agents, employees, contractors, permittees or invitees; except that Concessionaire shall have no responsibility for any release or threat of release of Hazardous Material which Concessionaire establishes was caused by the sole negligence or willful misconduct of City, City's officers, agents, employees, contractors or permittees by any third party, or by migration of Hazardous Materials onto the premises from a specifically identifiable source off the use premises. In addition to all other rights and remedies of City hereunder, if Concessionaire does not promptly commence, and diligently pursue to remediate, to the extent required, any such release, or threat of release, of Hazardous Materials for which it has responsibility under this section, City, in its discretion, may pay to have same remediated and Concessionaire shall reimburse City plus a fifteen percent administration fee within fifteen (15) business days of City's demand for payment. The failure to commence investigation and provide City with a schedule for diligent completion of the remediation within thirty (30) days after discovery of such release, or threat of release, of Hazardous Material shall constitute prima facie evidence of failure to promptly commence remediation. The demand for payment by City shall be prima facie evidence that expense was incurred by City.

Subsection 50.5 Records and Inspections.

- A. Concessionaire will maintain a chemical inventory list and material safety data sheets of hazardous materials stored on site in accordance with state and federal regulations. The Concessionaire will also maintain manifests for all hazardous or regulated wastes transported and disposed of off-site.
- B. Upon reasonable notice by City, Concessionaire shall make available for review by City such records pertaining to the use, handling and disposal of any Hazardous Material(s) as Concessionaire is required to maintain under this section.
- C. City shall have the right, under the terms hereof, and upon reasonable notice for exclusive use space, to enter the Leased Premises during the Term hereof to conduct periodic environmental inspections and testing. City shall conduct each inspection or test in a manner that does not unreasonably interfere with Concessionaire's operations.

Subsection 50.6 Concessionaire Obligations upon Termination. Prior to vacating the Leased Premises, and in addition to all other requirements under this Agreement, Concessionaire shall remove any containers of Hazardous Materials placed on the Leased Premises during the Term by Concessionaire or as a result of Concessionaire's use or occupancy of the Leased Premises during the Term and shall demonstrate to City's reasonable satisfaction that such removal is in compliance with all applicable Environmental Laws, including without limitation conducting any environmental audits as may be required by City.

Subsection 50.7 Storm Water.

- A. Notwithstanding any other provisions or terms of this Agreement, Concessionaire acknowledges that certain properties within the Airport, or on City-owned land, are subject to storm water rules and regulations. Concessionaire agrees to observe and abide by such storm water rules and regulations as may be applicable to City's property and Concessionaire's uses thereof.
- B. Concessionaire acknowledges that any storm water discharge permit issued to City may name Concessionaire as a co-permittee. City and Concessionaire both acknowledge that close cooperation is necessary to insure compliance with any storm water discharge permit terms and conditions, as well as to insure safety and to minimize cost of compliance. Concessionaire acknowledges further that it may be necessary to undertake such actions to minimize the exposure of storm water to "significant materials" generated, stored, handled or otherwise used by Concessionaire, as such term may be defined by applicable storm water rules and regulations, by implementing and maintaining "best management practices" as that term may be defined in applicable storm water rules and regulations.
- C. City will provide Concessionaire with written notice of any storm water discharge permit requirements applicable to Concessionaire and with which Concessionaire will be obligated to comply from time-to-time, including, but not limited to: certification of non-storm water discharges; collection of storm water samples; preparation of storm water pollution prevention or similar plans; implementation of best management practices; and maintenance of necessary records. Such written notice shall include applicable deadlines. Concessionaire agrees that within thirty (30) days of receipt of such written notice it shall notify City in writing if it disputes any of the storm water permit requirements it is being directed to undertake. If Concessionaire does not provide such timely notice, Concessionaire will be deemed to assent to undertake such storm water permit requirements. In that event, Concessionaire agrees to undertake, at its sole expense, unless otherwise agreed to in writing between City and Concessionaire, those storm water permit requirements for which it has received written notice from City, and Concessionaire agrees that it will hold harmless and indemnify City for any violations or non-compliance with any such permit requirements.

SECTION 51 – ISRAEL CLAUSE

Concessionaire hereby verifies that it does not boycott Israel and will not boycott Israel during the term of this Agreement. Boycotting Israel is defined in Texas Government Code section 808.001 to mean refusing to deal with, terminating business activities with, or taking any action that is intended to penalize, inflict economic harm on, or limit commercial relations specifically with Israel, or with a person or entity doing business in Israel or in an Israeli-controlled territory, but does not include an action made for

ordinary business purposes.

IN WITNESS WHEREOF, the parties have executed this Agreement in duplicate on this ____ day of _____, 2018.

ATTEST:

CITY OF KILLEEN:

Lucy Aldrich
City Secretary

Ronald L. Olson
City Manager

ATTEST:

Clearwater Transportation, Ltd

(name of signing authority)

(title)

EXHIBIT A1 - COUNTER/OFFICE/QUEUING AREAS

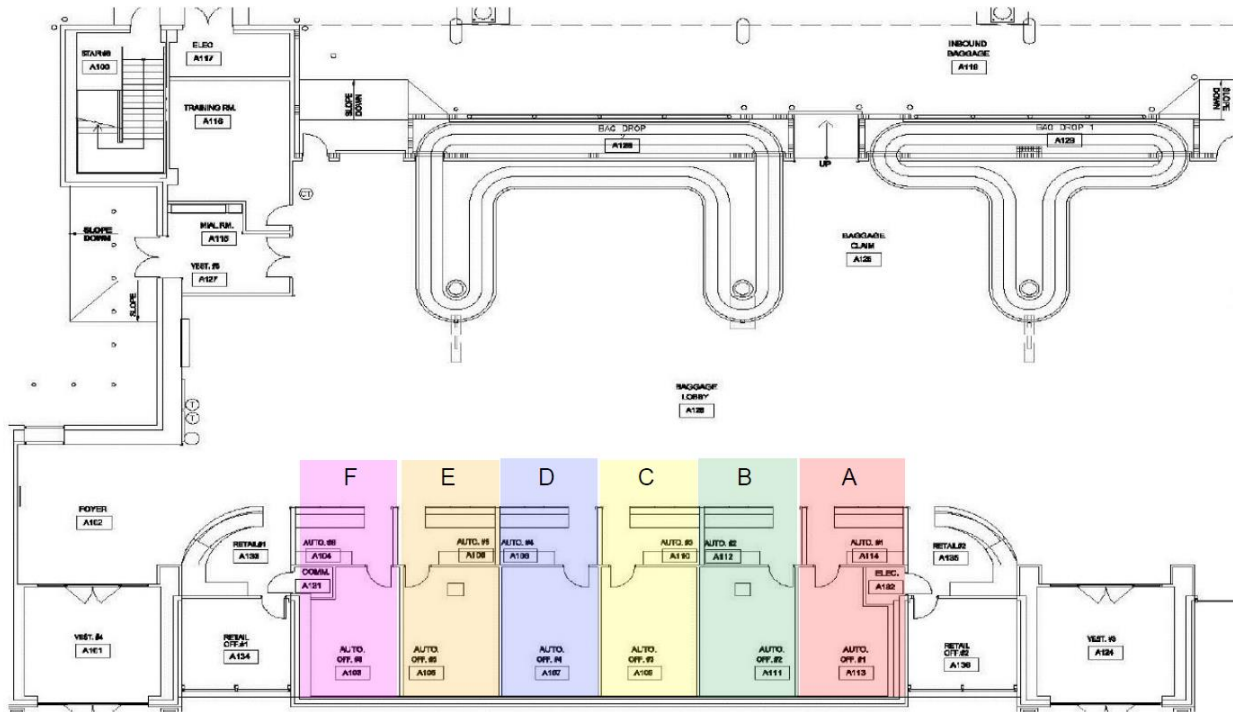

Space	Office	Counter Area	Queuing	Total Square Footage	Counter Length
A	199	107	102	408	12' 9"
B	232	109	103	444	12' 10"
C	232	109	103	444	12' 10"
D	232	109	103	444	12' 10"
E	232	109	103	444	12' 10"
F	199	104	102	405	12' 9"

REVISED EXHIBIT A2 - READY/RETURN BLOCKS AND SERVICE BAYS

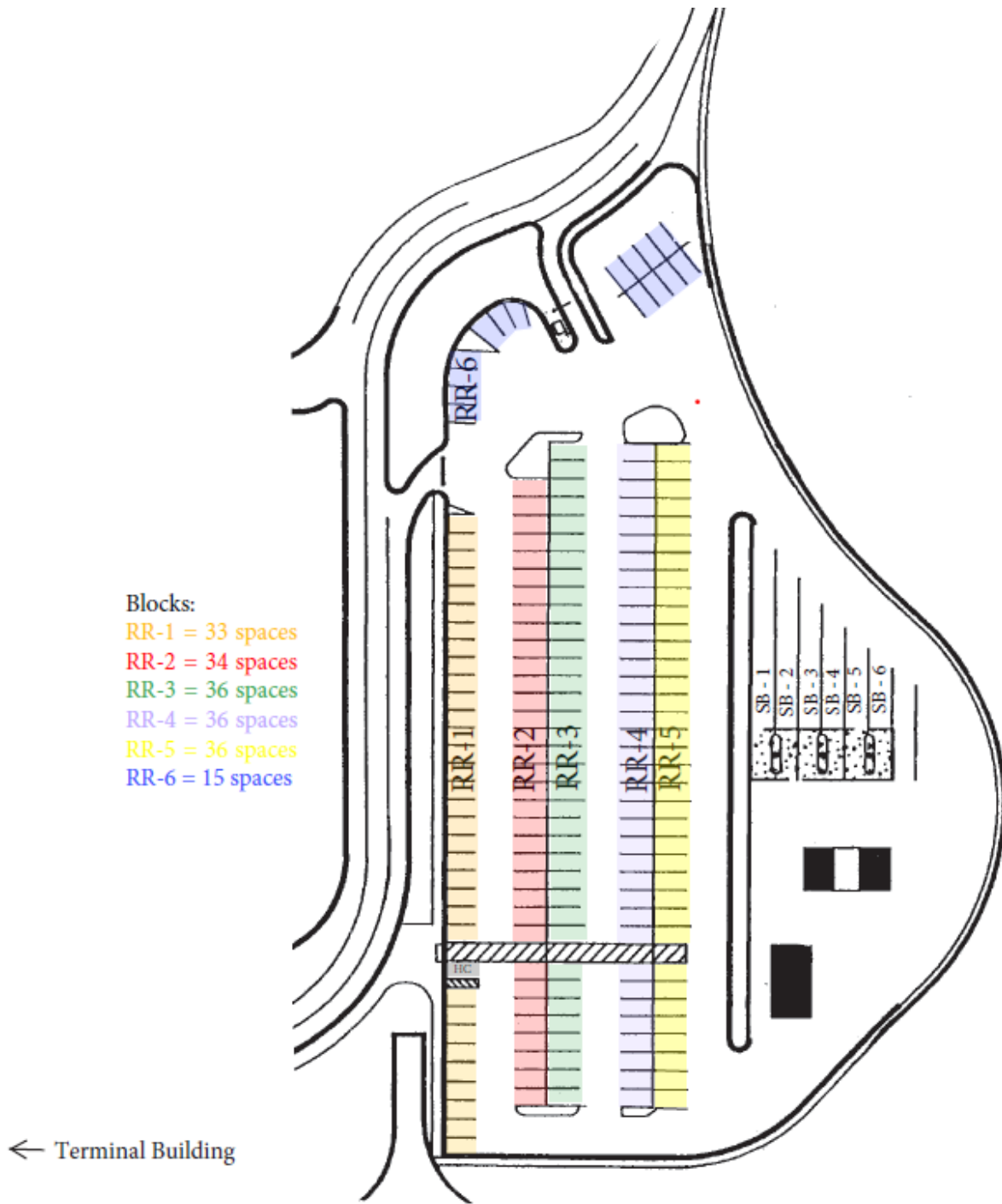

EXHIBIT A3 - STORAGE AREA

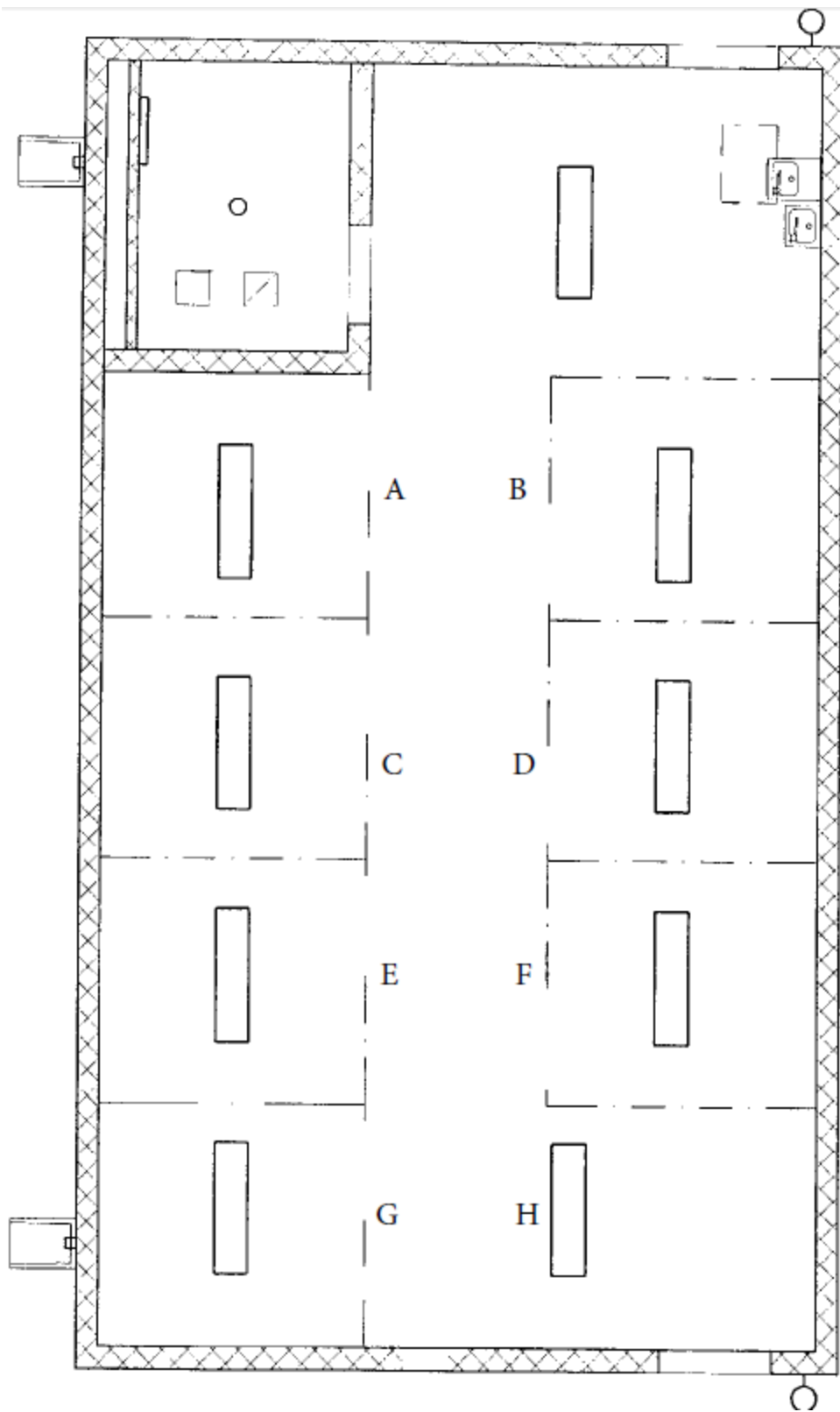

EXHIBIT A4 – OVERFLOW PARKING LANES

RENTAL CAR OVERFLOW
PARKING LOT

27 - LANES
Each lane 8'6" x 85'

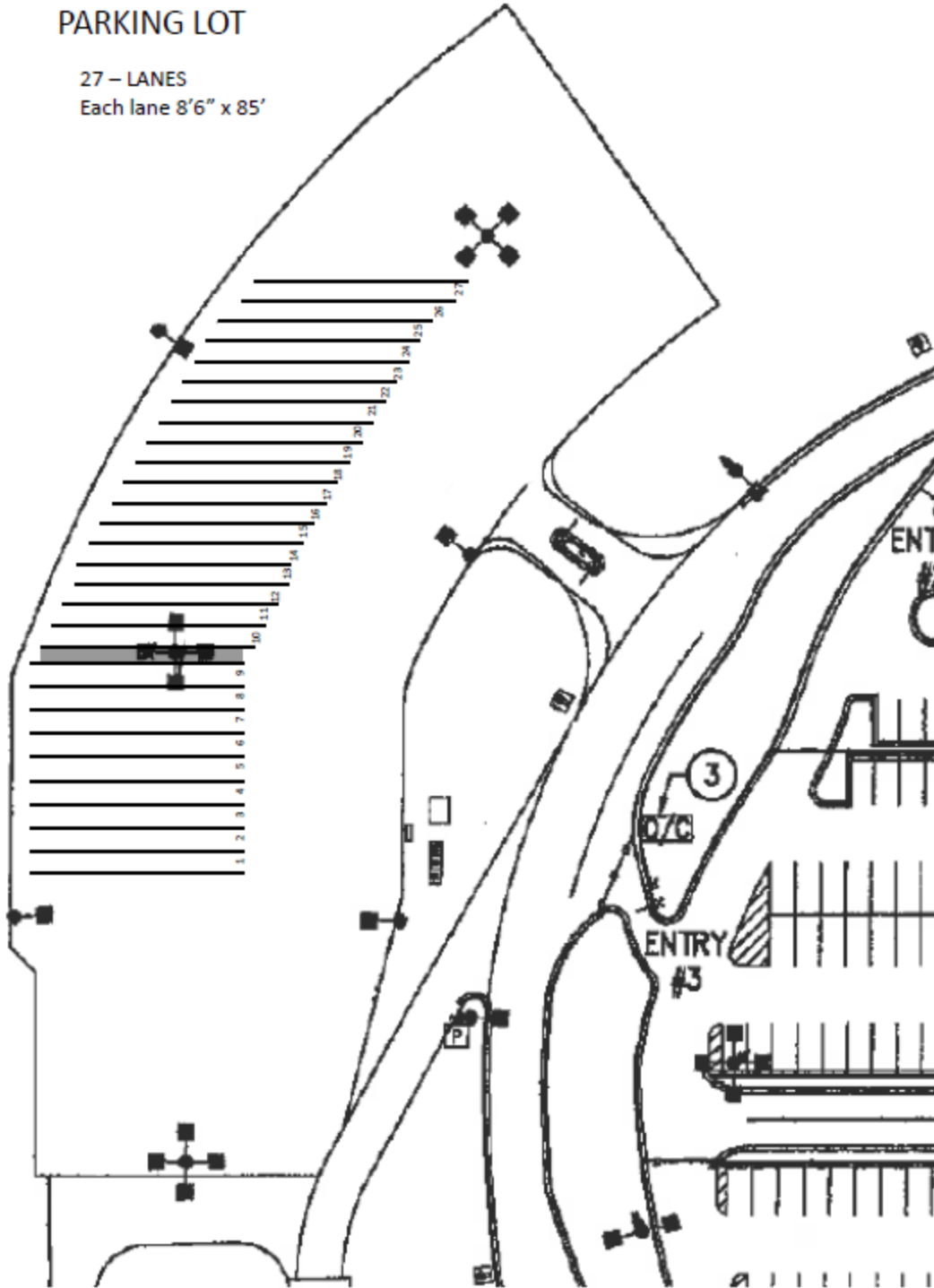

EXHIBIT B

KILLEEN – FORT HOOD REGIONAL AIRPORT
RENTAL CAR MONTHLY REPORT OF GROSS REVENUES
FOR MONTH OF _____

Concessionaire Name: _____

Address: _____

City, State, Zip: _____

Contact Name: _____

Phone # _____

GROSS RENTAL REVENUE: _____

Airport Fee (10%) _____

Less Monthly Guarantee paid 1st of month: _____

(1) Privilege Fee Balance Due: _____

Number of Transaction: _____

Number of Transaction Days: _____

(2) CFC Due (@ \$3.00 per Transaction Day): _____

Amount Due with this report (1) +(2): \$ _____

Concessionaire Official Signing and Certifying accuracy of Information on this report:

Signature _____

Typed Name & Title _____

Date signed _____

REMIT THIS FORM AND PAYMENT TO: City of Killeen Finance Department
Attn: Accounts Receivable
P.O. Box 1329
Killeen, TX 76540

CONCESSION AGREEMENT

NON-EXCLUSIVE RENTAL CAR CONCESSION
Killeen - Fort Hood Regional Airport
Killeen, Texas

between

Killeen - Fort Hood Regional Airport
City of Killeen, Texas

and

EAN Holdings, LLC d/b/a Enterprise Rent-A-Car

<u>Section</u>	<u>Page</u>
DEFINITIONS	6
SECTION 1 – LEASED PREMISES.....	9
SECTION 2 – TERM	9
SECTION 3 – USES, PRIVILEGES, COBRANDING AND OBLIGATIONS	9
SECTION 4 – RESTRICTIONS ON USES AND PRIVILEGES.....	11
SECTION 5 – PRIVILEGE FEE, RENTS, FEES AND ACCOUNTING RECORDS.....	11
Subsection 5.1 Privilege Fee, Rent and Fees.	11
Subsection 5.2 Statements, Books, and Records; Delinquent Rentals.	16
Subsection 5.3 Audit.....	17
SECTION 6 – INSTALLATION OF IMPROVEMENTS AND DESIGN, FURNISHING, AND EQUIPPING OF PREMISES	17
Subsection 6.1 Building Services	17
Subsection 6.2 Approval of Plans and Specifications; Provision of Drawings.....	17
SECTION 7 – TITLE TO IMPROVEMENTS, STRUCTURAL ALTERATIONS, ETC.	18
Subsection 7.1 Title.....	18
Subsection 7.2 Structural Alterations.....	19
Subsection 7.3 Alterations and Improvements to Airport.....	19
Subsection 7.4 Removal and Demolition.....	19
SECTION 8 – MAINTENANCE OF PREMISES	19
Subsection 8.1 Airport Maintenance Obligations.	19
Subsection 8.2 Concessionaire's Maintenance Obligations.	20
SECTION 9 – LIENS, PAYMENT, AND PERFORMANCE BONDS.....	21
Subsection 9.1 Construction Surety Bond.	21
Subsection 9.2.....	22
Subsection 9.3.....	22

SECTION 10 – OPERATION OF LEASED PREMISES: HOURS AND DELIVERIES	22
Subsection 10.1 Hours of Operation.....	22
Subsection 10.2 Delivery of Goods.	22
Subsection 10.3 Utilities.	22
 SECTION 11 – QUALITY AND CHARACTER OF SERVICE.....	23
Subsection 11.1 Type of Operation.	23
Subsection 11.2 Services to the General Public.....	23
Subsection 11.3 Additional Compliance.	23
Subsection 11.4 Personnel.....	23
 SECTION 12 – NON-DISCRIMINATION.....	24
 SECTION 13 – IDEMNIFICATION AND INSURANCE.....	24
Subsection 13.1 Indemnification.....	24
Subsection 13.2 Concessionaire to Provide General Liability and Automobile Insurance.	25
Subsection 13.3 Concessionaire to Provide Property and Fire Insurance.....	25
Subsection 13.4 Both Concessionaire and City to Carry Fire Insurance.	25
Subsection 13.5 Insurance Certificate.	26
Subsection 13.6 Concessionaire Failure to Provide Certificates.	26
 SECTION 14 – DAMAGE OR DESTRUCTION OF LEASED PREMISES	26
Subsection 14.1 Partial Damage.	26
Subsection 14.2 Extensive Damage.....	26
Subsection 14.3 Complete Destruction.	27
Subsection 14.4 Limits of City's Obligations Defined.....	27
 SECTION 15 – CANCELLATION	27
Subsection 15.1 Cancellation by Concessionaire.....	27
Subsection 15.2 Cancellation by City.	28
Subsection 15.3 Termination.	29
Subsection 15.4 Notice of Termination.....	29
 SECTION 16 – NONWAIVER OF RIGHTS	29
 SECTION 17 – SURRENDER OF POSSESSION	29
 SECTION 18 – TAXES AND LICENSES	29

SECTION 19 – INSPECTION OF PREMISES 30

SECTION 20 – HOLDING OVER 30

SECTION 21 – QUIET ENJOYMENT 30

SECTION 22 – NO LIENS..... 30

SECTION 23 – SECURITY AGREEMENTS 30

SECTION 24 – AGREEMENT SUBORDINATE TO AGREEMENTS WITH THE
UNITED STATES 30

SECTION 25 – RIGHTS AND PRIVILEGES OF CITY 31

SECTION 26 – ACCESS CONTROL 32

SECTION 27 – NO PERSONAL LIABILITY 33

SECTION 28 – GOVERNING LAW..... 33

SECTION 29 – NOTIFICATION 33

SECTION 30 – SEVERABILITY 34

SECTION 31 – ASSIGNMENT, SUBLET, AND TRANSFER 34

SECTION 32 – NO WAIVER 34

SECTION 33 – CONFLICTS OF INTEREST 34

SECTION 34 – POLITICAL ACTIVITIES..... 34

SECTION 35 – ENTIRE AND SUPERSEDING AGREEMENT 34

SECTION 36 – AMENDMENT	35
SECTION 37 – TIME COMPUTATION	35
SECTION 38 – NOTICES	35
SECTION 39 – CONSTRUCTION.....	36
SECTION 40 – NO THIRD PARTY BENEFICIARY	36
SECTION 41 – COMPLIANCE WITH LAW	36
SECTION 42 – FORCE MAJEURE.....	36
SECTION 43 – GOOD STANDING.....	36
SECTION 44 – INDEPENDENT CONTRACTORS	36
SECTION 45 – GOVERNMENTAL APPROVALS.....	37
SECTION 46 – AUTHORITY.....	37
SECTION 47 – COUNTERPARTS.....	37
SECTION 48 – SURVIVAL.....	37
SECTION 49 – MORE FAVORABLE TERMS.....	37
SECTION 50 – ENVIRONMENTAL.....	38
SECTION 51 – ISRAEL CLAUSE	40
EXHIBIT A1 - COUNTER/OFFICE/QUEUING AREAS	42
EXHIBIT A2 - READY/RETURN BLOCKS AND SERVICE BAYS	43

EXHIBIT A3 – STORAGE AREA..... 43

EXHIBIT A4 – OVERFLOW PARKING LANES..... 44

EXHIBIT B..... 45

RENTAL CAR CONCESSION
Killeen - Fort Hood Regional Airport
Killeen, Texas

THIS CONCESSION AGREEMENT ("**Agreement**"), made and entered into this 1st day of January, 2019, by and between the City of Killeen (the "**City**"), a municipal corporation and existing under the laws of the State of Texas, whose address is 8101 S. Clear Creek Rd, Box C, Killeen, Texas 76549, hereinafter referred to as "City" and EAN Holdings, LLC operating as Enterprise Rent-A-Car, (hereinafter referred to as "**Concessionaire**"), a limited liability company with its office and address being 4210 South Congress Avenue, Austin TX 78745, with a mailing address of 4210 South Congress Avenue, Austin TX 78745.

WITNESSETH:

WHEREAS, City controls, owns, operates, and maintains an airport in the City of Killeen, County of Bell, State of Texas, known as Killeen - Fort Hood Regional Airport (hereinafter referred to as "Airport"), and has the power to grant rights and privileges with respect thereto, and

WHEREAS, the City has determined it to be in the best interests of the public and the City to enter into this Agreement with Concessionaire to provide rental car concession services at the Airport pursuant and subject to the terms and conditions hereunder,

NOW, THEREFORE, THE PARTIES AGREE:

DEFINITIONS

The following terms and phrases shall have the following meanings for purposes of this Agreement:

1. "ACDBE" shall mean airport concession disadvantaged business enterprise as that term is defined by 49 CFR Part 23.
2. "City" shall mean the municipal corporation existing under the laws of the State of Texas which controls, operates, and maintains the Killeen - Fort Hood Regional Airport.
3. "Environmental Law" shall mean any federal, state or local law, rule, regulation, order or requirement relating to protection of human health and safety or the environment.
4. "Executive Director of Aviation" shall mean the Executive Director of Aviation of the City's Airport, or his or her designee.
5. "Gross Revenues" as used herein shall mean, as determined in the reasonable discretion of the City, all amounts charged to its customers by Concessionaire for or

in connection with agreements it secures through its operations and business at the Airport, regardless of whether such amount is actually paid to or received by Concessionaire. Gross Revenues shall include all monies or other consideration of whatsoever nature paid or payable to Concessionaire by customers for all sales made and services performed for cash, credit or consideration in connection with automobile and vehicle rentals or other products or services provided to persons through Concessionaire's operations at the Airport, without regard to the ownership, area, fleet, or location assignment of vehicles and without regard to the manner in which or place at which the vehicles or other products or services are furnished to Concessionaire's customers and without regard to whether the vehicles or other products are returned to the Airport or to some other location.

Gross Revenues shall include anything and everything that is not specifically excluded. The only exclusions from Gross Revenues permitted under this Agreement shall be the specific exclusions set forth below:

- Federal, state, county, city or municipal sales, use, or excise taxes now in effect or hereinafter levied on Concessionaire's operations which are separately stated on customers' rental contracts and collected from customers of Concessionaire;
 - Those fees referred to in this Agreement as Customer Facility Charges, "CFCs" which for the purpose of this Agreement shall include all customer facility charges, authorized pursuant to City Resolution, as may be amended;
 - Amounts received specifically for the actual loss of or damages of vehicles or other property of Concessionaire;
 - Amounts received from the sale of vehicles off-Airport premises; provided, however, any amounts paid in connection with automobile and vehicle rentals or other products or services provided to persons through Concessionaire's operations that are applied to or otherwise reimbursed as a result of the sale of a vehicle shall not be excluded from Gross Revenues; and
 - Reimbursements for amounts actually paid for speeding tickets, parking tickets, red light tickets, tolls and toll violations, and towing and impound fees from its customers to pass through without markup to an independent third party with no amount being retained by Concessionaire. However, any amounts collected above the pass through amount shall be included as Gross Revenue under this Agreement.
6. "Hazardous Material" shall mean any material that, because of its quantity, concentration or physical or chemical characteristics, is deemed by any federal, state or local governmental authority to pose a present or potential hazard to human health or safety or to the environment, and includes any material or substance

identified, listed, or defined as a "hazardous waste" "hazardous substance," or "pollutant" or "contaminant" or term of similar import, or is otherwise regulated pursuant to Environmental Laws, including any asbestos and asbestos-containing materials; petroleum, including crude oil or any fraction thereof, natural gas or natural gas liquids.

7. "Leasehold Improvements" shall mean all improvements and equipment which are affixed to the Leased Premises and which cannot be removed without material damage to the Premises.
8. "Operations Year" shall mean January 1 through December 31 annually.
9. "Personal Property" shall mean all movable property of the Concessionaire not directly related to the rental car operations of the privileges granted hereunder, including, office furniture, office equipment, and office supplies.
10. "Refurbish" or "Refurbishment" shall mean the routine repainting or redecoration of public areas within the Leased Premises, as necessary, including the replacement or repair of worn carpet, tile, furniture, or furnishings.
11. "Rental Car" or "Motor Vehicles" shall mean motor vehicles designed primarily for the carriage of passengers and commonly classified as sedans, coupes, convertibles, station wagons, four-wheel drive vehicles, passenger vans, sport utility vehicles, and pick-up trucks rated one-ton or less. Concessionaire shall not park, store, or rent from Premises any vehicles except Motor Vehicles as defined herein that it owns or rents and are properly available for rental as provided herein.
12. "Terminal Building" shall mean the terminal building at the Airport.
13. "Trade Fixtures" shall mean all non-affixed items, except expendables and Personal Property, which can be removed without damage to the Leased Premises, including cash registers, safes, patron tables and chairs, display fixtures, and the like.
14. "Transaction" shall mean the execution of an agreement or contract for the rental of a Motor Vehicle; or, the payment of funds or completion of a cash or credit transaction for payment for rental of a Motor Vehicle; or delivery of a Motor Vehicle to a customer for use in exchange for cash, credit or any other consideration.
15. "Transaction Day" shall mean each twenty-four (24) hour period or portion thereof, for which a customer of a Rental Car concessionaire rents, or otherwise enters into a similar arrangement for the use of a Motor Vehicle and for which the Rental Car concessionaire collects revenue from the customer. Late returns (after twenty four (24) hours) shall be considered a Transaction Day.

SECTION 1 – LEASED PREMISES

- A. City hereby leases to Concessionaire and Concessionaire hereby agrees to lease from City the following premises, which, collectively, are hereinafter called the "Leased Premises": Four Hundred and Forty Four (444) square feet of counter/office/queuing area "D" in the terminal building, Block "RR-1" the ready return area containing approximately 33 ready/return parking spaces outside and adjacent to the terminal building, and Service Bay "5". Said Leased Premises is more particularly shown on **Exhibits A1, A2, and A3** attached hereto and by this reference made a part hereof.
- B. Concessionaire agrees that its Leased Premises have been inspected by Concessionaire and are accepted and will be occupied by Concessionaire on an "as is" basis. The Concessionaire specifically waives any covenants or warranties regarding the Premises, including but not limited to any warranty of suitability and warranty of fitness.

SECTION 2 – TERM

The term of this Agreement is for a five (5) year period commencing on January 1, 2019 and terminating on December 31, 2023 unless sooner terminated or canceled as hereinafter provided.

SECTION 3 – USES, PRIVILEGES, COBRANDING AND OBLIGATIONS

Concessionaire shall have the following uses, privileges, and obligations in connection with its use of the Leased Premises:

- A. The non-exclusive right, privilege, and obligation to conduct and operate a rental car, van or truck rental concession at the Airport. Co-Branding by Concessionaire is limited to two brands per concession space specifically those listed in their submitted proposal. It being understood that no more than two brands under rental car agencies which are owned by the same parent company may operate from any one concession space during the term of this agreement. Concessionaire understands and agrees that it shall not engage in any other business on the Airport under this Agreement.
- B. The right, privilege, and obligation to rent and check-in rental vehicles, including the right to offer for sale related collision damage waiver protection, personal injury and accident insurance, personal effects insurance, and such other travel or vehicle related coverage offered in connection with and incidental to the rental of a vehicle and occupy operations office, storage, and Ready and Return car parking spaces. It is the intent of this Agreement that rental car customers of Concessionaire will operate the vehicle rented only from the ready spaces provided herein, and Concessionaire shall not engage in customer shuttle operations of any kind to, from, or on the Airport. This does not prohibit the picking up of a customer from the Fixed Base Operator (FBO). No trucks larger

than ¾ ton pickup type/style will be allowed in the ready lot unless approved in writing in advance by the Executive Director of Aviation.

- C. The non-exclusive right and privilege to wash vehicles rented by Concessionaire under the provisions of this Agreement in the City's car wash.
- D. The right and privilege to service vehicles rented by the Concessionaire under the provisions of this Agreement in the service bay identified in Section 1. Concessionaire shall use the service bay for the following activities only: vehicle automated and hand washing, cleaning, fluid replacement, vacuuming, and related activities as are necessary for preparing its vehicles for rental. No washing or vehicle maintenance may be conducted in the rental car parking lot or overflow parking areas.
- E. The right of ingress and egress to and from the Premises, over Airport roadways, is subject to such reasonable rules and regulations as may be established by Airport as respecting such use and subject to law.
- F. Concessionaire shall install no signs on or about the Premises without the prior written approval of the Executive Director of Aviation, said approval being solely discretionary with the Executive Director of Aviation. For purposes of this Section, signs shall include, but not necessarily be limited to, identification signs, company logos, advertising or promotions, photographs, art displays, and the like. Such signs shall be substantially uniform in size, types and location with those of other concessionaries, and subject to Executive Director of Aviation's approval, Rules and Regulations, and in compliance with all applicable laws and resolutions. No temporary signs or displays shall be permitted on the backwall or the counter surfaces without the prior written approval of the Executive Director of Aviation. Handwritten, or hand lettered signs are prohibited. Concessionaire shall not place or install any racks, stands, trade fixtures, pedestal signs, or other displays of products outside the boundaries of the Leased Premises without the express prior written approval of the Executive Director of Aviation.
- G. The right for Concessionaire's employees, in common with other employees of tenants of the Terminal Building, to use vehicular parking space provided by City, subject to the payment of reasonable charges therefore, as set by the City.
- H. *Airport Concession Disadvantaged Business Enterprise Program*
 - 1. This agreement is subject to the requirements of the U.S. Department of Transportation's regulations, 49 CFR Parts 23 and 26 related to the airport concession disadvantaged business enterprises (ACDBE) program. The concessionaire or contractor agrees that it will not discriminate against any business owner because of the owner's race, color, national origin, or sex in connection with the award or performance of any concession agreement, management contract, or subcontract, purchase or lease

agreement, or other agreement covered by 49 CFR Part 23.

2. The concessionaire or contractor agrees to include the above statements in any subsequent concession agreement or contract covered by 49 CFR Part 23, that it enters and cause those businesses to similarly include the statements in further agreements.
3. Each year Concessionaire no later than (90) days following end of each Operational Year shall provide to City the following annual ACDBE information: the name and address of each certified ACDBE with which it has done business during the past year, a description of the nature of the services performed by and/or items purchased from each firm named, and the dollar value of each transaction.

SECTION 4 – RESTRICTIONS ON USES AND PRIVILEGES

The Leased Premises shall be used only for the purposes specified in this Agreement. Concessionaire understands and agrees that City has the right to grant up to five additional privileges under separate agreements for in-terminal rental car operations to other companies.

Prohibited Activities at the service bay include:

- A. Concessionaire shall not utilize the service bay for vehicle storage other than vehicles for rent in the process of being serviced.
- B. Concessionaire shall not utilize the service bay for any maintenance or for the storage of damaged vehicles.
- C. Concessionaire shall not allow its customers or the general public to enter the service bay.
- D. Concessionaire shall not permit its employees to vacuum, wash or fuel their personal vehicles or vehicles not part of the Concessionaire's fleet at the service bay or fueling area.

SECTION 5 – PRIVILEGE FEE, RENTS, FEES AND ACCOUNTING RECORDS

Subsection 5.1 Privilege Fee, Rent and Fees.

- A. *Privilege Fee.* As consideration for the privilege of operating the concession hereunder, Concessionaire shall pay to City each contract year, for the full term of this Agreement, a Privilege Fee. Said Privilege Fee shall be the greater of either the guaranteed Minimum Annual Privilege Fee or the Percentage Fee applicable to Gross Revenue, hereinafter defined, as follows:

1. Privilege Fee – the greater of either:
 - a. ten percent (10%) of the Concessionaire’s annual Gross Revenues (“Percentage Privilege Fee”);

OR

- b. the respective yearly amount shown below as the Concessionaire’s Minimum Annual Guaranteed fee (“MAG”):

January 1, 2019 to December 31, 2019	\$	152,618.00
January 1, 2020 to December 31, 2020	\$	152,618.00
January 1, 2021 to December 31, 2021	\$	152,618.00
January 1, 2022 to December 31, 2022	\$	152,618.00
January 1, 2023 to December 31, 2023	\$	152,618.00

2. Monthly payment shall be the greater of 1/12th of the respective year’s MAG or 10% of reported gross revenues for the previous month. The MAG payment shall be paid in advance on the first (1st) day of each month during each Operations Year, until such time as the Concessionaire has paid to the Airport an amount equal to the respective annual MAG identified in Section 5.1(A)(1)(b) above. On or before the 20th of each month the Concessionaire shall provide the Airport with: i) a signed and certified Report of Gross Revenues for the preceding month and ii) payment of any percentage Privilege Fee shown to be due for the preceding month, as designated on Exhibit B, attached hereto and made a part hereof. Once the sum of Privilege Fee payments remitted has reached the MAG in any given Operations Year, the Concessionaire may cease remittance of the 1/12th of the respective year’s MAG on the first (1st) day of each month for the remainder of that Operations Year. The Concessionaire shall continue to report and remit each and every month after the annual MAG has been reached the full 10% of reported gross revenues for the previous month.
3. In the event of a major traffic reduction at GRK, during the term of this Agreement, the MAG hereinabove provided for in this Section 5.1(A) above shall be abated for the period of time the condition exists. A major traffic reduction at GRK shall be defined as a twenty five percent (25%) reduction in the number of passengers deplaning on scheduled airline flights at GRK during any period of three (3) consecutive calendar months as compared to the number of such deplaning passengers in the same calendar months during the preceding calendar year.
4. Concessionaire acknowledges that Privilege Fee payments by Concessionaire to City under this Agreement are for Concessionaire’s privilege to use the Airport facilities and access the Airport market and are not fees imposed by City upon Concessionaire’s customers. City does not require, but will not prohibit, a separate statement of and charge for the Privilege Fee on customer invoices or rental agreements (“Recovery

Fee”), provided that such Recovery Fee meets all of the following conditions: (a) such Recovery Fee must be titled “Concession Recovery Fee,” “Concession Recoupment Fee” or such other name first approved by the Executive Director of Aviation in writing; (b) the Recovery Fee must be shown on the customer rental car agreement and invoiced with other Concessionaire charges (i.e. “above the line”); (c) the Recovery Fee as stated on the invoice and charged to the customer shall be no more than 11.11% of Gross Revenues and shall be specifically included in the Definition of Gross Revenues for purposes of remittance to City; (d) Concessionaire shall neither identify, treat, or refer to the Recovery Fee as a tax, nor imply that City is requiring the pass through of such fee; (e) Concessionaire shall comply with all applicable laws, including Federal Trade Commission requirements, any Texas Consumer Protection legislation and any commitment to or contractual obligation by Concessionaire with any governmental agency or officer with authority over Concessionaire’s activities.

B. Rent -

1. Rent for Premises

Concessionaire shall pay to the City, in advance, on the 1st day of each month, one twelfth the following annual rents or the monthly rent as applicable:

a) For the period commencing January 1, 2019 through December 31, 2019, Concessionaire shall pay the sum of Twenty-five Dollars and Thirty-two Cents (\$25.32) per square foot per annum for Four Hundred and Forty Four (444) square feet of counter/office/queuing position in the Terminal Building. On January 1 of each year for the period of this Agreement, commencing January 1, 2020, the rental amounts for the counter/office/queuing space, shall be adjusted in accordance with the Consumer Price Index – National Index for All Urban Consumers for the previous calendar year. Said adjustment shall be computed as follows:

$$\begin{aligned} &\text{Most recent year's rate x} \\ &\quad (\text{CPI for November of most recent year} / \\ &\quad \text{CPI for November of the next most recent year}) = \text{New Rate} \end{aligned}$$

b) For the period commencing January 1, 2019 through December 31, 2019, Concessionaire shall pay the sum of Twenty-three Thousand Seven Hundred and Sixty Dollars (\$23,760), per annum for Ready Return Block RR-1 as shown on Exhibit A2. On January 1 of each year for the period of this Agreement, commencing January 1, 2020, the rental amounts for the parking block, shall be adjusted in accordance with the Consumer Price Index – National Index for All

Urban Consumers for the previous calendar year, as described above.

- c) For the period commencing January 1, 2019 through December 31, 2019, Concessionaire shall pay the sum of Four Thousand Eight Hundred Dollars (\$4,800), per annum for service bay “5” as shown on Exhibit A2. On January 1 of each year for the period of this Agreement, commencing January 1, 2020, the rental amounts for the service bay, shall be adjusted in accordance with the Consumer Price Index – National Index for All Urban Consumers for the previous calendar year, as described above.
- d) For the period commencing January 1, 2019 through December 31, 2023, Concessionaire declined lease of a storage area as shown on Exhibit A3.
- e) If requested by Concessionaire, overflow parking lanes as agreed upon with the Executive Director of Aviation on a month to month basis in the amount of \$150 per lane per month through December 31, 2019. On January 1 of each year for the period of this Agreement, commencing January 1, 2020, the rental amounts for the overflow parking lanes, shall be adjusted in accordance with the Consumer Price Index – National Index for All Urban Consumers for the previous calendar year, as described above. Overflow lanes are shown on Exhibit A4.

C. Additional Fees –

- 1. The Concessionaire shall collect the CFCs on behalf of the Airport and remit to the Airport, in accordance with the City’s CFC resolution, the full amount of the Transaction Day fee collected from each Rental Car customer.
- 2. The Concessionaire shall pay to the City for telephone system/service access to the Internet via a T-1 as follows:

Local service	\$23.50 per line per month
Voice mail	\$4.25 per line per month
Phone rental	\$6.00 per phone per month
Maintenance fee	\$15.50 per line per month

Above telecommunication fees are subject to change as determined by the City. Payment shall be due within thirty (30) days of invoice date.

- 3. The Concessionaire shall pay to the City a per wash fee of \$2.00 per automated wash. The Concessionaire shall pay to the City, for use of the manual car wash, a rate of \$1.25 per 5 minute session.

Car wash fees are subject to change as determined by the City with advance written notice. Payment shall be due within thirty (30) days of invoice date.

4. The Concessionaire shall pay to the City, based on actual gallons of fuel pumped, a per gallon fuel rate equal to the City's purchase price of the fuel plus \$0.15 cents, as may be adjusted by the City with advance written notice.

Payment shall be due within thirty (30) days of invoice date.

5. If the Concessionaire's bid reflected the operation of two brands in its concession, Concessionaire shall pay to the City a fee of One Thousand Dollars (\$1,000) per month which shall be paid in advance on the first (1st) of each month.
6. Additional fees may include charges for special items or activities including, but not limited to, employee parking, monthly electronic access card fees, badging fees, and disposal of debris left in service bay area and assigned parking areas. The City may assess reasonable, non-discriminatory and cost-recovery based charges for these special items or activities. All new charges will be reviewed with Concessionaire prior to implementation. Other charges payable by Concessionaire shall be paid by Concessionaire to City no later than thirty (30) days following receipt by Concessionaire of billing therefor.
7. Concessionaire shall be charged, at the current short term parking rate, for any of its vehicles found to be parked in a parking space not specifically leased by the Concessionaire or without the approval of the Executive Director of Aviation.

- D. Any and all payments due to the City by Concessionaire shall be remitted to the following address:

City of Killeen Finance Department
Attn: Accounts Receivable
P.O. Box 1329
Killeen, TX 76540

- E. Year End Adjustments to Privilege Fees, Rents and Fees.

In the event the amount of payments made during the preceding Operations Year exceeds the total of any payments due for such Operations Year, the excess payment shall be credited against the payments for the next Operations Year, except that any excess payment during the final Operations Year of this Agreement will be returned to the Concessionaire within thirty (30) days after the

Airport's acceptance of the final Certified Statement described in this Section. Concessionaire shall submit separate system generated reports for each brand name operated.

Subsection 5.2 Statements, Books, and Records; Delinquent Rentals.

- A. Monthly Statements; Books and Records. Within twenty (20) days after the close of each calendar month of the term of this Agreement, Concessionaire shall submit to City, in such detail and on the statement form designated as Exhibit B or as may reasonably be specified by City, certain information, including but not limited to, the number of Transactions executed during the preceding month, the number of Transaction Days Motor Vehicles were rented during the preceding month, and the statement of its Gross Revenues during the preceding month upon which the percentage payments to City set forth in Subsection 5.1 A(1) are to be computed, and said Exhibit B statement to be signed by a responsible accounting officer of Concessionaire. City reserves the right to change the form of the monthly statement and to require the submission by Concessionaire of other information pertaining to the Gross Revenues hereunder, and Concessionaire agrees to change the form of its statements to that requested by City and to provide any such additional information City may reasonably request. Concessionaire shall keep full and accurate books and records showing all of its Gross Revenues hereunder, and City shall have the right, through its representatives and at reasonable times, at its own expense, to inspect, examine, copy, and audit such books and records, including State of Texas sales tax return records. Concessionaire hereby agrees that all such books and records will be made available to City for at least three (3) years following the period covered by such books and records.
- B. Annual Certified Statements. Each year during the term of this Agreement, Concessionaire shall provide to City a written statement, certified by an independent Certified Public Accountant, to City stating that in his or her opinion the Percentage Fees paid by Concessionaire to City during the preceding year pursuant to this Agreement were made in accordance with the terms of this Agreement. Said statement shall be submitted by Concessionaire, to be received by City within ninety (90) days of the end of each contract year. Such statement shall also contain a list of the Gross Revenues, by month, as shown on the books and records of Concessionaire and which were used to compute the Percentage Fee payments made to City during the period covered by said statement.
- C. Delinquent Rentals and Fees. Without waiving any other right or action available to City in the event of default in the payment of charges or fees payable to City, pursuant to this Agreement, a late fee of one and a half percent (1.5%) of the total amount due will be assessed to the Concessionaire if payments prescribed above are not received by the dates prescribed therein. An additional one and a half percent (1.5%) of the outstanding amount will be assessed each month that all or a portion of the Concessionaire's obligations remain unpaid.

Subsection 5.3 Audit. City reserves the right to audit Concessionaire's books and records pertaining to the Leased Premises, at its own expense, at any time for the purpose of verifying the Gross Revenues, Privilege Fee and CFC calculation hereunder for any period three (3) years prior to such audit. If, however, as a result of such audit, it is established that Concessionaire has understated the Gross Revenues received from all operations at the Leased Premises by two percent (2%) or more (after the deductions and exclusions herein), the entire expense of said audit shall be borne by Concessionaire. Any additional Privilege Fee due shall forthwith be paid by Concessionaire to City with interest thereon at one and one-half percent (1.5%) per month from the date such additional Privilege Fee became due.

SECTION 6 – INSTALLATION OF IMPROVEMENTS AND DESIGN, FURNISHING, AND EQUIPPING OF PREMISES

Subsection 6.1 Building Services

- A. City Improvements and Services. City shall initially insure and provide occupancy of the Leased Premises to Concessionaire with said Leased Premises meeting all federal, state and local code requirements for the operation of a rental car concession. City shall provide and maintain water, sewer, general lighting, electrical power, heating and air-conditioning, and telephone system/service access to the Internet via a T-1 for the Terminal Building. Heating and air conditioning, electrical service, and telephone system/service access to the Internet via T-1 are provided to the Leased Premises only. If Concessionaire requires additional lighting, electrical power, water, or adjustments to the air-conditioning system or telephone system, such additional improvements or services shall be subject to the prior written approval of Executive Director of Aviation, and any such approved improvements or services shall be made at Concessionaire's expense.
- B. Concessionaire's Right to Additional Services. Concessionaire shall have the right, at its own expense, to request and receive additional services or systems, provided that any such services or systems shall require the written approval of Executive Director of Aviation before installation.

Subsection 6.2 Approval of Plans and Specifications; Provision of Drawings.

- A. General. Any improvements to be made to or upon the Leased Premises by Concessionaire, and any subsequent alterations or additions to such improvements, shall be subject to the prior written approval of Executive Director of Aviation. Full and complete plans and specifications for all work, facilities, improvements, and finishes, and the time required to complete same, shall be submitted to and receive the written approval of Executive Director of Aviation before any work or construction is commenced, which shall not be unreasonably withheld or delayed. First-class standards of design and construction shall be complied with in connection with all such

work, facilities, and improvements; and all construction shall conform to the general architectural requirements of Executive Director of Aviation as established for each improvement program. Two (2) copies of plans for all improvements or subsequent changes therein or alterations thereof shall be given to Executive Director of Aviation for review prior to commencement of construction; after final approval by Executive Director of Aviation, Executive Director of Aviation shall return to Concessionaire one (1) approved copy for Concessionaire's records and shall retain one (1) approved copy as an official record thereof.

- B. Improvements Conform to Statutes, Ordinances, Etc. All improvements, furniture, fixtures, equipment, and finishes, including the plans and specifications therefore, constructed or installed by Concessionaire, its agents, or contractors, shall conform in all respects to applicable statutes, ordinances, building codes, and rules and regulations, and public bidding laws. Any approval given by City shall not constitute a representation or warranty as to such conformity; responsibility therefore shall at all times remain with Concessionaire.
- C. Approvals Extend to Architectural and Aesthetic Matters. Approval of City shall extend to and include architectural and aesthetic matters and City reserves the right to reasonably reject any layout or design proposals submitted and to require Concessionaire to resubmit any such layout or design proposals until they meet Executive Director of Aviation approval.
- D. Disapprovals. In the event of disapproval by City of any portion of any plans or specifications, Concessionaire shall promptly submit necessary modifications and revisions thereof for approval by Executive Director of Aviation. City agrees to act promptly upon such plans and specifications and upon requests for approval of changes or alterations in said plans or specifications. No substantial changes or alterations shall be made in said plans or specifications after initial approval by City, and no alterations or improvements shall be made to or upon the Leased Premises without the prior written approval of Executive Director of Aviation.
- E. Provision of As-Built Drawings. Upon completion of any construction project, Concessionaire shall provide City two (2) completed sets of as-built drawings in reproducible form as specified by City. Concessionaire agrees that, upon the request of City, Concessionaire will inspect the Leased Premises jointly with City to verify the as-built drawings.

SECTION 7 – TITLE TO IMPROVEMENTS, STRUCTURAL ALTERATIONS, ETC.

Subsection 7.1 Title. All improvements made to the Leased Premises by Concessionaire, and any additions and alterations thereto made by Concessionaire, shall be and remain the property of Concessionaire until the termination of this Agreement (whether by expiration of the term, cancellation, forfeiture or otherwise), at

which time said improvements, except for Trade Fixtures, personal property, and expendables, shall become the property of City, at no cost to City.

Subsection 7.2 Structural Alterations. Concessionaire shall make no structural alterations to the Leased Premises without the prior written consent of Executive Director of Aviation.

Subsection 7.3 Alterations and Improvements to Airport. Concessionaire acknowledges that from time to time City may undertake construction, repair, or other activities related to the operation, maintenance and repair of the Terminal Building which may temporarily affect Concessionaire's operations hereunder. Concessionaire agrees to accommodate City in such matters, even though Concessionaire's own activities may be inconvenienced, and Concessionaire agrees that no liability shall attach to City, its members, employees, or agents by reason of such inconvenience or impairment. It is agreed that in the event such activities of City substantially impair the operations of Concessionaire under this Agreement, the Minimum Privilege Fee shall be waived during such period of substantial impairment, with what constitutes "substantial impairment" being reasonably determined by Executive Director of Aviation after consultation with Concessionaire. Concessionaire agrees that if relocation is required that Concessionaire shall move its operations as reasonably directed by Executive Director of Aviation.

Subsection 7.4 Removal and Demolition. Concessionaire shall not remove or demolish, in whole or in part, any Leasehold Improvements upon the Leased Premises without the prior written consent of City which may, at its sole discretion, condition such consent upon the obligation of Concessionaire, at Concessionaire's cost, to replace the same by an improvement specified in such consent.

SECTION 8 – MAINTENANCE OF PREMISES

Subsection 8.1 Airport Maintenance Obligations.

- A. General Maintenance and Operation. City agrees that it will, with reasonable diligence, maintain, operate, and keep in good repair the Airport, including the Terminal Building and all appurtenances, facilities, and services now or hereafter connected therewith. Airport shall keep the car rental parking lot and the overflow parking area in suitable repair, and provide general lighting for these areas.
- B. Structural Maintenance. City shall provide, or cause to be provided, structural maintenance of the Terminal Building.
- C. Maintain Access. City shall, throughout the term of this Agreement, maintain all airport-owned roads on the Airport giving access to the Terminal Building in good and adequate condition for use by cars and trucks and shall maintain free and uninterrupted access to the Terminal Building over said road at all times. City reserves the right to reasonably restrict access to the Terminal

Building area for automobile deliveries during peak activity periods.

- D. Car Wash. City will maintain and inspect the car wash facilities as recommended by the manufacturer including routine maintenance of the car wash for normal activities, wear and tear. Normal and routine maintenance of roofs, walls, utility infrastructure, building mechanical systems and structural building components will be performed by City. Wash soaps, rinses, brushes, hoses, and utilities will be provided by the City. City has the exclusive authority to stop the use of the car wash for maintenance and inspections as is necessary, at City's sole discretion, without damage or liability to Concessionaire. City will take reasonable action to notify Concessionaire for closure of the car wash.

- E. Telephone System/Service Access to the Internet via a T-1. The Airport shall furnish telephone system/service access to the Internet via a T-1. Rates for these services will be in accordance with Section 5.1(C). A letter of agreement or other suitable document will be executed between the Airport's Executive Director of Aviation or his/her designated representative and the local designated representative of the Concessionaire to document exactly which services are agreed to between the two parties. Airport reserves the right to change or terminate said telephone and/or internet service at some point during the term of this Agreement. Airport will provide at least a ninety (90) day notice to Concessionaire of any service changes and assist in facilitating replacement services via a local communication provider.

Subsection 8.2 Concessionaire's Maintenance Obligations.

- A. Concessionaire's General Obligations. Except for maintenance of the Terminal Building, Car Wash, and Telephone System, as provided in Subsection 8.1, Concessionaire shall be obligated, without cost to City, to maintain the Leased Premises and every part thereof in good appearance, repair, and safe condition. Concessionaire shall maintain and repair all Leasehold Improvements on the Leased Premises and all furnishings, fixtures, and equipment therein, whether installed by Concessionaire or by others, including repainting or redecorating as necessary, and replacing or repairing worn carpet, tile, fixtures, or furnishings. All such maintenance and repairs shall be at least of quality equal to the original in materials and workmanship, and all work, including paint colors, shall be subject to the prior written approval of Executive Director of Aviation. Concessionaire shall be obligated, without cost to City, to provide custodial service to Leased Premises. Concessionaire shall be responsible for the replacement cost of lost keys and floor finish restoration.

- B. Hazardous Conditions. Upon discovery, Concessionaire shall immediately give oral notice to Airport of any hazardous or potentially hazardous conditions in the Leased Premises or in the Terminal Building. Any hazardous or potentially hazardous condition in the Leased Premises shall be

corrected immediately upon receipt of oral notice from the Executive Director of Aviation. At the direction of said Director, Concessionaire shall close the Leased Premises until such hazardous or potentially hazardous condition is removed.

- C. **Trash and Refuse.** City shall provide, at no cost to Concessionaire, a container for the adequate sanitary handling of all trash and other refuse caused as a result of the operation of the Leased Premises. Concessionaire shall be responsible for disposal of its own trash accumulations by depositing it in the nearest exterior trash dumpster on a daily basis. Concessionaire will regularly inspect exterior areas assigned to them and will remove all trash and debris. Failure to do so will result in the City completing this task and a fee assessed to the Concessionaire for the service. Trash receptacles inside the terminal building are for customer use only. Piling of boxes, cartons, barrels, or other similar items in view of a public area is prohibited. Concessionaire shall keep any areas used for trash and garbage storage prior to removal from Airport in a reasonably clean and orderly condition so as not to unduly attract rodents, pests, or birds, or create an offensive odor. Concessionaire also agrees to participate in the City's recycling program by depositing all recyclable products in the appropriate outside recycling containers in lieu of the trash dumpster.
- D. **Transporting Trash and Refuse.** In transporting trash and refuse from the Leased Premises, Concessionaire shall ensure that trash is not strewn around while taking refuse to the dump site. Such disposal shall take place during hours as may be approved by the City.
- E. **Damage to Equipment.** Concessionaire will be responsible for the cost of replacement equipment deemed to be damaged by their employees due to negligence.

SECTION 9 – LIENS, PAYMENT, AND PERFORMANCE BONDS

Subsection 9.1 Construction Surety Bond. Concessionaire shall not allow any liens or encumbrances to be attached to the Leased Premises. Prior to the commencement of any construction or alteration hereunder which exceeds \$10,000 in cost, Concessionaire or its contractor shall furnish to City, and without expense to City, a surety bond, issued by a surety company licensed to transact business in the State of Texas and satisfactory to and approved by City with Concessionaire's contractor or contractors as principals, in a sum not less than one hundred percent (100%) of the total cost of the contract or contracts for the construction or alteration of the improvements and facilities mentioned herein. Said bond shall guarantee the prompt payment to all persons supplying labor, materials, provisions, supplies, and equipment used directly or indirectly by said contractor, subcontractor(s), and suppliers in the prosecution of the work provided for in said construction contract and shall protect City from any liability, losses, or damages arising there from.

Subsection 9.2 Compliance with Federal Aviation Regulations, 14 CFR Part 139, and Transportation Security Administration security requirements 49 CFR Part 1542. Concessionaire agrees to comply with Federal Aviation Regulations, and 1542 (Airport Security), U.S. Army requirements, and the City's policies as outlined in City's approved Operations Plan and Airport Security Plan. Concessionaire further agrees that any fines levied upon the City or Concessionaire through enforcement of these regulations because of acts by Concessionaire's employees, agents, suppliers, guests, or patrons shall be borne by Concessionaire to the extent said acts contributed to said fines.

Subsection 9.3 Security. During the term of this Agreement, the City shall require the Operator to deliver (and thereafter maintain current for the entire term of this Agreement) an instrument of security in a form satisfactory to the City, in its sole discretion, in the amount of twenty-five percent (25%) of Concessionaire's Minimum Annual Guarantee for each year hereunder, in order to secure the performance of all of Concessionaire's obligations under this Agreement, including without limitation, the payment of all the percentages, minimums, fees, charges and costs set out herein. Said security may be in the form of a bond.

SECTION 10 – OPERATION OF LEASED PREMISES: HOURS AND DELIVERIES

Subsection 10.1 Hours of Operation. Concessionaire shall actively operate in the Leased Premises and shall use a business-like operation therein. The Concessionaire shall be open to serve the public seven (7) days per week and hours of operation shall be such that passengers of flights arriving or departing from the terminal will be accommodated. In no event shall the hours of operation be curtailed to an extent that the service contemplated under this Agreement shall be diminished. Except as otherwise stated herein, the hours of service shall be determined in light of changing public demands and airline operating schedules. Concessionaire may advise the Executive Director of Aviation of Concessionaire's analysis of the optimum arrangements, but the final determination shall be made by the Executive Director of Aviation based on their analysis of necessary service to the public.

Subsection 10.2 Delivery of Goods. Concessionaire shall arrange for the timely delivery of all motor vehicles and supplies, at such times, in such locations(s), and by such routes as determined by City. Concessionaire shall abide by all Transportation Security Administration (TSA) requirements for parking of motor vehicles near the terminal building.

Subsection 10.3 Utilities.

- A. City shall provide the Leased Premises with heat and air-conditioning to keep the Leased Premises at reasonable temperatures for the conduct of Concessionaire's activities. City shall have the right to set, monitor, adjust and restrict thermostat settings to levels it determines to be appropriate.

- B. City shall provide electricity to the Leased Premises by means of wiring installations, and Concessionaire shall make such connections as required and permitted by building code. At no time shall Concessionaire's use of electric current exceed the capacity of the wiring installation in place.

SECTION 11 – QUALITY AND CHARACTER OF SERVICE

Subsection 11.1 Type of Operation. Concessionaire shall maintain and operate the concession privileges granted hereunder in an orderly, proper, and first-class manner, which, in the sole judgment of Executive Director of Aviation, does not unduly annoy, disturb, or offend others at the Airport.

Subsection 11.2 Services to the General Public. Concessionaire understands and agrees that its operation at the Airport necessitates the rendering of public services such as giving directions, and generally assisting the public.

Subsection 11.3 Additional Compliance. Concessionaire shall comply with all applicable governmental laws, ordinances, and regulations in the conduct of its operations under this Agreement.

Subsection 11.4 Personnel.

- A. General. Concessionaire shall maintain a sufficient number of properly trained personnel to ensure that all customers of Concessionaire receive prompt and courteous service. All such personnel, while on or about the Leased Premises, shall be polite, clean, appropriately attired, and neat in appearance. Clothing will be neat and clean and present a professional appearance. Executive Director of Aviation shall have the right to object to the demeanor, conduct, and appearance of any employee of Concessionaire, or any of its invitees or those doing business with it, whereupon Concessionaire shall take all steps necessary to remedy the cause of the objection. Concessionaire will ensure that its counter is staffed at all times during the posted hours of operation.
- B. Manager. The management, maintenance, and operation of the Leased Premises and the concession conducted thereon shall be at all times during the term hereof under the supervision and direction of an active, qualified, competent, and experienced manager, who shall at all times be authorized to represent and act for Concessionaire. Concessionaire shall cause such manager to be available during normal business hours, and Concessionaire will at all times during the absence of such manager assign, or cause to be assigned, a qualified subordinate to assume and be directly responsible for the carrying out of his or her duties.

SECTION 12 – NON-DISCRIMINATION

This agreement is subject to the requirements of the U.S. Department of Transportation's regulations, 49 CFR Part 23, pursuant to law, it is unlawful and Concessionaire agrees not to willfully refuse to employ, to discharge, or to discriminate against any person otherwise qualified because of race, color, religion, sex, sexual orientation, age, disability, national origin or ancestry, lawful source of income, marital status, creed, or familial status; not to discriminate for the same reason in regard to tenure, terms, or conditions of employment, not to deny promotion or increase in compensation solely for these reasons; not to adopt or enforce any employment policy which discriminates between employees on account of race, color, religion, sex, creed, age, disability, national origin or ancestry, lawful source of income, marital status or familial status; not to seek such information as to any employee as a condition of employment; not to penalize any employee or discriminate in the selection of personnel for training, solely on the basis of race, color, religion, sex, sexual orientation, age, disability, national origin or ancestry, lawful source of income, marital status, creed or familial status.

Concessionaire shall include or cause to be included in each subcontract covering any of the services to be performed under this Agreement a provision similar to the above paragraph, together with a clause requiring such insertion in further subcontracts that may in turn be made.

SECTION 13 – IDEMNIFICATION AND INSURANCE

Subsection 13.1 Indemnification. To the fullest extent allowable by law, Concessionaire hereby indemnifies and shall defend and hold harmless, at Concessionaire's expense, City, its elected and appointed officials, committee members, officers, employees or authorized representatives or volunteers, from and against any and all suits, actions, legal or administrative proceedings, claims, demands, damages, liabilities, losses, interest, attorney's fees (including in-house counsel legal fees), costs and expenses of whatsoever kind, character or nature whether arising before, during, or after completion of the Agreement hereunder and in any manner directly or indirectly caused or contributed to in whole or in part, by reason of any act, omission, fault, or negligence, whether active or passive of Concessionaire, or of anyone acting under its direction or control or on its behalf in connection with or incident to the performance of this Agreement, regardless if liability without fault is sought to be imposed on City. Concessionaire's aforesaid indemnity and hold harmless agreement shall not be applicable to any liability caused by the negligent or willful misconduct of City, its elected and appointed officials, officers, employees or authorized representatives or volunteers. Nothing in this Agreement shall be construed as City waiving its statutory limitation and/or immunities as set forth in the applicable Texas Statutes or other applicable law. This indemnity provision shall survive the termination or expiration of this Agreement.

Concessionaire shall reimburse City, its elected and appointed officials, officers, employees or authorized representatives or volunteers for any and all legal expenses

and costs incurred by each of them in connection therewith or in enforcing the indemnity herein provided. Concessionaire's obligation to indemnify shall not be restricted to insurance proceeds, if any, received by City, its elected and appointed officials, officers, employees or authorized representatives or volunteers.

To the extent allowed by law, except for damage or injury caused by the willful or negligent act or omission of Concessionaire, its agents or employees, City shall indemnify, defend and save Concessionaire, its agents, representatives, and employees from any and all lawsuits, claims, loss and damages of any nature whatsoever, including damage to property of any Concessionaire and the injury, including death, of employees, agents, or customers of Concessionaire, arising either directly or indirectly out of any operations of the City hereunder, except lawsuits, claims, loss and damages arising out of the sole negligence of the Concessionaire, their employees, or agents.

Subsection 13.2 Concessionaire to Provide General Liability and Automobile Insurance. Concessionaire shall, at its sole expense, obtain and maintain in effect at all times during this Agreement the following insurance coverage:

- A. Commercial General Liability Insurance of not less than \$5,000,000 per occurrence for bodily injury, personal injury and property damage;
- B. Automobile Insurance of not less than \$5,000,000 per occurrence;
- C. To the extent that Concessionaire employs any employees or as otherwise required by law, Workers' Compensation and Employers' Liability Insurance with Texas statutory limits.

Subsection 13.3 Concessionaire to Provide Property and Fire Insurance. Concessionaire, at its own expense, shall insure all Leasehold Improvements and furnishings, fixtures and equipment for fire, extended coverage, vandalism, and malicious mischief. Such insurance shall be in an amount equal to the full insurable replacement value of such improvements. All property insurance policies shall contain loss payable endorsements in favor of the parties as their respective interests may appear hereunder and shall contain a waiver of subrogation provision in favor of the City. Concessionaire and City agree that any payments received by either from such insuring companies by reason of loss under such policy or policies shall be applied toward repair and reconstruction of said Leasehold Improvements and repair or replacement of leasehold improvements, furnishings, fixtures and equipment.

Subsection 13.4 Both Concessionaire and City to Carry Fire Insurance. It is understood that both Concessionaire and City carry insurance in the form of fire, extended coverage, vandalism, and malicious mischief (hereinafter called "Insurance Coverage") on the leased structural part of the premises, permanent improvements and loss of income, (in the case of City) and on Leasehold Improvements, furniture, furnishings, equipment, inventory and loss of income, (in the case of Concessionaire), and said Insurance Coverage authorizes a waiver of subrogation between City and Concessionaire, and the parties wish to enter into such waiver of subrogation to the

extent of the said Insurance Coverage; therefore, to the extent that City collects under its Insurance Coverage, City waives any and all claims against Concessionaire, its agents, servants, and employees, for loss or damage to City's property resulting from risks included in said Insurance Coverage; and, to the extent that Concessionaire collects under its Insurance Coverage, Concessionaire waives any and all claims against City, its agents, servants, and employees, for loss or damage to Concessionaire's property resulting from risks included in said Insurance Coverage. If this waiver by the parties shall render fully any such insurance policy or shall result in the denial of coverage for a party under such policy, then the provision paragraph shall be deemed to be null and void.

Subsection 13.5 Insurance Certificate. A certificate evidencing insurance required by Subsection 13.2 and 13.3, and listing the City of Killeen as additional insured, excluding Workers' Compensation and Property and Fire Insurance, shall be filed with City prior to the commencement of construction, furnishing and equipping of Leasehold Improvements by Concessionaire upon the Leased Premises, and such certificate shall provide that such Insurance Coverage will not be canceled or reduced without at least thirty (30) days prior written notice to City. Prior to the expiration of any such policy, a certificate showing that such Insurance Coverage has been renewed shall be filed with City. If such Insurance Coverage is canceled or reduced, Concessionaire shall within fifteen (15) days after receipt of written notice from City of such cancellation or reduction in coverage, file with City a certificate showing that the required insurance has been reinstated or provided through another insurance company or companies.

Subsection 13.6 Concessionaire Failure to Provide Certificates. In the event that Concessionaire shall at any time fail to furnish City with the certificate or certificates required under this Section, City, upon written notice to Concessionaire of its intention so to do, shall have the right to obtain the required insurance, at the cost and expense of Concessionaire, and Concessionaire agrees to promptly reimburse City for the cost thereof, plus fifteen percent (15%) thereof for administrative overhead.

SECTION 14 – DAMAGE OR DESTRUCTION OF LEASED PREMISES

Subsection 14.1 Partial Damage. If all or a portion of the Leased Premises is partially damaged by fire, explosion, the elements, public enemy, or other casualty, but not rendered untenable, the same will be repaired with due diligence by City subject to the limitations of Subsection 14.4; provided, however, to the extent that such damage or destruction is not covered by insurance, Concessionaire shall be responsible for reimbursing City for the cost and expenses insured in such repair to the extent that the damage is caused by the negligent act or omission of Concessionaire, its sublessees, agents, or employees.

Subsection 14.2 Extensive Damage. If the damages referred to in Subsection 14.1 shall be so extensive as to render the Terminal Building Premises untenable, but capable of being repaired in thirty (30) days, the same shall be repaired with due diligence by City subject to the limitations of Subsection 14.4; and the charges payable

herein for the MAG and Rent under Section 5.1 shall abate from the time of such damage or destruction until such time as the said Leased Premises are fully restored and certified by City's Engineers as ready for occupancy; provided, however, the said fees and charges will not abate and to the extent that such damage or destruction is not covered by insurance, Concessionaire shall be responsible for reimbursing City for the cost and expenses incurred in such repair to the extent that the damage is caused by the negligent act or omission of Concessionaire, its sublessees, agents, or employees.

Subsection 14.3 Complete Destruction. In the event the Terminal Building Premises are completely destroyed by fire, explosion, the elements, the public enemy, or other casualty, or so damaged that they are untenable and cannot be replaced for more than thirty (30) days, City shall undertake the repair, replacement, and reconstruction of said Leased Premises; and charges payable herein for the MAG and Rent under Section 5.1, shall abate as of the time of such damage or destruction until such time as the said Premises are fully restored and certified by City's Executive Director of Aviation as ready for occupancy; provided, however, the said fees and charges will not abate and to the extent that such damage or destruction is not covered by insurance, Concessionaire shall be responsible for reimbursing City for the costs and expenses incurred in said repair to the extent that the damage is caused by the negligent act or omission of Concessionaire, its sublessees, agents, or employees; provided further, however, if within twelve (12) months after the time of such damage or destruction said Leased Premises shall not have been repaired or reconstructed, Concessionaire may cancel this Agreement in its entirety. Rents payable for the leased areas in the Terminal Building and/or Ready/Return Block will only abate if the City is unable to provide alternative space for Concessionaire to conduct its business.

Subsection 14.4 Limits of City's Obligations Defined. It is understood that, in the application of the foregoing Subsections, City's obligations shall be limited to repair or reconstruction of the Leased Premises to the same extent and of equal quality as obtained at the commencement of operations hereunder, subject to funding and appropriation. Redecoration and replacement of furniture, fixtures, equipment, and supplies shall be the responsibility of Concessionaire and any such redecoration and refurbishing/re-equipping shall be of equivalent quality to that originally installed hereunder.

SECTION 15 – CANCELLATION

Subsection 15.1 Cancellation by Concessionaire. Concessionaire may cancel this Agreement and terminate all its obligations hereunder upon or after the happening of one or more of the following events and provided that Concessionaire is not in default in the payment of any fees or charges to City:

- A. The abandonment of the Airport as an airline terminal or the removal of all certificated passenger airline service from the Airport for a period of no less than thirty (30) consecutive days.
- B. The inability of Concessionaire to use the Airport for a period of longer than

ninety (90) days, because of the issuance of any order, rule, or regulation by any competent governmental authority or court having jurisdiction over Concessionaire or City, preventing Concessionaire from operating its business; provided, however, that such inability or such order, rule, or regulation is not primarily due to any fault of Concessionaire.

- C. The material breach by City in the performance of any covenant or agreement herein required to be performed by City and the failure of City to remedy such breach for a period of sixty (60) days after receipt from Concessionaire of written notice to remedy the same.

Subsection 15.2 Cancellation by City. City may cancel this Agreement and terminate all of its obligations hereunder at any time that City is not in default, upon or after the happening of any of the following events:

- A. Concessionaire shall file a voluntary petition in bankruptcy; or
- B. Proceedings in bankruptcy shall be instituted against Concessionaire and Concessionaire is thereafter adjudicated bankrupt pursuant to such proceedings; or
- C. A court shall take jurisdiction of Concessionaire and its assets pursuant to proceedings brought under the provisions of any federal reorganization act; or
- D. A receiver of Concessionaire's assets shall be appointed; or
- E. Concessionaire voluntarily abandons its conduct of its business at the Airport for a period of thirty (30) days, except if such is due to a labor strike or labor dispute in which Concessionaire is involved; or
- F. Any assignment is made by Concessionaire for the benefit of its creditors; or
- G. The material breach by Concessionaire of any of the covenants or agreements herein contained and the failure of Concessionaire to remedy such breach as hereinafter provided. In this regard it is understood that nonpayment of fees or charges hereunder is a material breach. In the event of such material breach, City shall give to Concessionaire notice in writing to correct such breach and if such breach shall continue for fifteen (15) days after the receipt of such notice by Concessionaire, City may, after the lapse of said fifteen (15) day period, cancel this Agreement, without forfeiture, waiver, or release of City's rights to any sum of money due or to become due under the provisions of this Agreement.
- H. The lawful assumption by the United States Government, or any authorized agency thereof, of the operation, control or use of the Airport and facilities, or any substantial part or parts thereof, in such manner as to substantially restrict Concessionaire, for a period of at least thirty (30) days, from its Airport

operation.

Subsection 15.3 Termination. Should an early termination of this Agreement occur pursuant to the terms of Subsection 15.2 hereof, City shall have the right to re-enter the Leased Premises, make repairs as necessary, and enter into another agreement for the Leased Premises and privileges, or any part thereof, for the remainder of the term hereof.

Subsection 15.4 Notice of Termination. If any of the events enumerated in Subsections 15.1 and 15.2 shall occur and after due notice the defaulting party has failed to cure or correct same, the complaining party may, at any time thereafter during the continuance of said default, terminate this Agreement by notice in writing, such cancellation and termination to be effective upon the date specified in such notice.

SECTION 16 – NONWAIVER OF RIGHTS

Continued performance by either party hereto pursuant to the terms of this Agreement after a default of any of the terms, covenants, and conditions herein contained to be performed, kept, or observed by the other party hereto shall not be deemed a waiver of any right to cancel this Agreement for any subsequent default; and no waiver of any such default shall be construed or act as a waiver of any subsequent default.

SECTION 17 – SURRENDER OF POSSESSION

Concessionaire shall, upon termination of this Agreement or cancellation, quit and deliver up the Leased Premises and privileges to City peaceably and quietly, with the Leased Premises being in as good order and condition as the same now are or may be hereafter improved by Concessionaire or City, reasonable use and wear thereof excepted. In addition to any lien provided by Texas law, City shall have a specific lien on all property of Concessionaire, and related equipment on the Leased Premises as security for nonpayment. Concessionaire shall have the right to remove all of its trade fixtures and equipment installed or placed by it at its own expense, in, on or about the Premises; subject however, to any valid lien which City may have thereon for unpaid charges or fees. Provided however, the City will not claim or have a lien of any kind, be it contractual or statutory, on or against Concessionaire's motor vehicles for non-payment of any rent or fees due under the Agreement, or for any default of Concessionaire or any other reason, and the City hereby waives all such liens available to the City.

SECTION 18 – TAXES AND LICENSES

Concessionaire shall obtain and pay for all licenses or permits necessary or required by law for the construction of improvements, the installation of equipment and furnishings, and any other licenses necessary for the conduct of its operations hereunder.

SECTION 19 – INSPECTION OF PREMISES

City or its duly authorized representatives, or agents, and other persons for it, may enter upon said Leased Premises at any and all reasonable times during the term of this Agreement for the purpose and conditions hereof or for any other purpose incidental to rights of City.

SECTION 20 – HOLDING OVER

Should Concessionaire holdover said Leased Premises after this Agreement has terminated in any manner, Concessionaire shall continue such holding over only at sufferance to City. In the event of such holding over, Concessionaire shall pay to the City the amounts specified in Subsection 5.1, the amounts being the amounts in effect immediately prior to the commencement of such holdover.” All other terms and conditions in such holdover shall be the same as herein provided.

SECTION 21 – QUIET ENJOYMENT

City agrees that Concessionaire, upon payment of the fees and charges and all other payments to be paid by Concessionaire under the terms of this Agreement, and upon observing and keeping the agreements and covenants of this Agreement on the part of Concessionaire to be observed and kept, shall lawfully and quietly hold, occupy, and enjoy the Leased Premises during the term of this Agreement.

SECTION 22 – NO LIENS

Concessionaire shall pay for all labor done or materials furnished in the repair, replacement, development, or improvement of the Premises by Concessionaire, and shall keep said Leased Premises and Concessionaire's possessory interest therein free and clear of any lien or encumbrance of any kind whatsoever created by Concessionaire's act or omission.

SECTION 23 – SECURITY AGREEMENTS

City shall provide, or cause to be provided, during the term of this Agreement, all proper and appropriate public fire and police protection similar to that afforded to other Landside tenants or licensees at the Airport, and it will issue and enforce rules and regulations with respect thereto for all portions of the Airport. Concessionaire shall comply with the Airport Security Plan and shall have the right, but shall not be obligated, to provide such additional or supplemental public protection as it may desire, but such right, whether or not exercised by Concessionaire, shall not in any way be construed to limit or reduce the obligations of City hereunder.

SECTION 24 – AGREEMENT SUBORDINATE TO AGREEMENTS WITH THE UNITED STATES

This Agreement is subject and subordinate to the terms, reservations, restrictions, and

conditions of any existing or future agreements between the City and the United States, the execution of which has been or may be required as a condition precedent to the transfer of federal rights or property to the City for Airport purposes, and the expenditure of federal funds for the extension, expansion, or development of the Killeen - Fort Hood Regional Airport. Should the effect of such Agreement with the United States government be to take any of the property under lease or substantially destroy the commercial value of such improvements, City shall terminate this Agreement.

SECTION 25 – RIGHTS AND PRIVILEGES OF CITY

- A. City shall have the right to enforce, and adopt from time to time, reasonable rules and regulations, which Concessionaire agrees to observe and obey, with respect to the use of the Airport, Airport Terminal Building and appurtenances, provided that such rules and regulations shall not be inconsistent with safety, current rules and regulations of the FAA, and any future changes prescribed from time to time by the FAA.
- B. The City Manager or designee is hereby designated as its official representative for the enforcement of all provisions in this Agreement with full power to represent City with dealings with Concessionaire in connection with the rights herein granted.
- C. All actions relating to policy determination, modification of this Agreement, termination of this contract, and any similar matters affecting the terms of this Agreement shall emanate from the City Council, their successors or assigns.
- D. The Executive Director of Aviation or designee may enter upon the Leased Premises, now or hereafter leased to Concessionaire hereunder, at any reasonable time, for any purpose necessary, incidental to, or connected with, the performance of its obligations hereunder, or in the exercise of its governmental functions.
- E. City reserves the right to further plan, develop, improve, remodel and/or reconfigure the Airport, including the Leased Premises and existing vehicle and pedestrian traffic patterns, as the City deems appropriate, regardless of the desires or views of Concessionaire, and without interference or hindrance.
- F. City hereby reserves for the use and benefit of the public, the right of aircraft to fly in the airspace overlying the land herein leased, together with the right of said aircraft to cause such noise as may be inherent in the operation of aircraft landing at, taking off from, or operating on or in the vicinity of Killeen - Fort Hood Regional Airport, and the right to pursue all operations of the Killeen - Fort Hood Regional Airport.
- G. City reserves the right to take any action it considers necessary to protect the aerial approaches of the Airport against obstruction, together with the right to prevent Concessionaire from erecting, or permitting to be erected, any

building or other structure on the Airport, which, in the opinion of the City, would limit the usefulness of the Airport, or constitute a hazard to aircraft.

- H. City may from time to time increase the size or capacity of any such Public Aircraft Facilities or Passenger Terminal Building or Common Use Portion of the Airport or make alterations thereto or reconstruct or relocate them or modify the design and type of construction thereof or close them or any portions of them, either temporarily or permanently, provided notice is given to Concessionaire.
- I. This Agreement at any time may be reopened for renegotiation if Federal Aviation Administration (FAA) Airport Certification (FAR Part 139), Transportation Security Administration (TSA) Security Requirements (49 CFR, Part 1542), or U.S. Army regulations result in major expenditures to City due to Concessionaire's tenancy on the Killeen - Fort Hood Regional Airport. If said renegotiation is desired, written notice must be given to Concessionaire sixty (60) days prior to such renegotiations.
- J. City reserves the right to relocate the Leased Premises upon the completion of any Terminal area remodeling or expansion. City will not be liable for the costs associated with the moving or reinstallation of Concessionaire's equipment. In the event the City requires a move by the Concessionaire, the City will reimburse actual out-of-pocket costs associated with the relocation as approved in advance subject to a maximum amount as established by the City.

SECTION 26 – ACCESS CONTROL

- A. Concessionaire shall upon termination of this agreement return all issued keys and access cards to City. If all issued keys and access cards are not returned to City at the termination of this Agreement Concessionaire shall pay to City cost to re-core premises locks and cut new keys at the rate set at the time of such re-core and to pay for any lost access cards.
- B. Concessionaire is responsible for all keys and access cards issued to employees of Concessionaire. Concessionaire is responsible to insure every employee that has regular duty at the Airport is submitted for airport electronic access cards appropriate for that employee and that all employee data remains current. The Concessionaire will notify the appropriate representative of the Airport by telephone or other appropriate means as soon as possible following the termination of any employee, but will do so in writing no later than the end of the next working day after the employee's last day of employment at the Airport. The Concessionaire is further responsible for returning the employee's electronic access cards no later than three (3) working days after the last day of employment at the Airport. Any lost electronic access cards must be reported in writing to the Airport's representative as soon as possible, but no later than the end of the next

working day from the date of the loss. Concessionaire is responsible for any charges or damages incurred by the use of electronic access cards issued to its employees unless more than 24 hours (excluding weekends and City of Killeen recognized holidays) have passed from the time the Concessionaire provides written notification to the Airport's representative to cancel any access these electronic access cards allow. A monthly fee will be charged for active employee electronic access cards and for lost cards at the current rates adopted by the City.

- C. Concessionaire may not install additional locks or change locks to Leased Premises without the written approval of the Executive Director of Aviation.

SECTION 27 – NO PERSONAL LIABILITY

Under no circumstances shall any trustee, officer, official, commissioner, Director, member, partner or employee of City have any personal liability arising out of this Agreement, and Concessionaire shall not seek or claim any such personal liability.

SECTION 28 – GOVERNING LAW

This Agreement and all questions and issues arising in connection herewith shall be governed by and construed in accordance with the laws of the State of Texas. Venue for any action arising out of or in any way related to this Agreement shall be exclusively in Bell County, Texas. Each party waives its right to challenge venue.

SECTION 29 – NOTIFICATION

Concessionaire shall:

- A. As soon as possible and in any event within a reasonable period of time after the occurrence of any default, notify City in writing of such default and set forth the details thereof and the action which is being taken or proposed to be taken by Concessionaire with respect thereto.
- B. Promptly notify City of the commencement of any litigation or administrative proceeding that would cause any representation and warranty of Concessionaire contained in this Agreement to be untrue.
- C. Notify City, and provide copies, immediately, upon receipt, of any notice, pleading, citation, indictment, complaint, order or decree from any federal, state or local government agency or regulatory body, asserting or alleging a circumstance or condition that requires or may require a financial contribution by Concessionaire or any guarantor or an investigation, clean-up, removal, remedial action or other response by or on the part of Concessionaire or any guarantor under any environmental laws, rules, regulations, ordinances or which seeks damages or civil, criminal or punitive penalties from or against Concessionaire or any guarantor for an alleged violation of any environmental

laws, rules, regulations or ordinances.

SECTION 30 – SEVERABILITY

The provisions of this Agreement are severable. If any provision or part of this Agreement or the application thereof to any person or circumstance shall be held by a court of competent jurisdiction to be invalid or unconstitutional for any reason, the remainder of this Agreement and the application of such provision or part thereof to other persons or circumstances shall not be affected thereby.

SECTION 31 – ASSIGNMENT, SUBLET, AND TRANSFER

Concessionaire shall not assign, sublet, or transfer its interests or obligations under the provisions of this Agreement without the prior written consent of City, which shall not be unreasonably withheld or delayed. This Agreement shall be binding on the heirs, successors, and assigns of each party hereto. Concessionaire shall provide not less than forty-five (45) days advance written notice of any intended assignment, sublet or transfer.

SECTION 32 – NO WAIVER

The failure of any party to insist, in any one or more instance, upon performance of any of the terms, covenants, or conditions of this Agreement shall not be construed as a waiver, or relinquishment of the future performance of any such term, covenant, or condition by any other party hereto but the obligation of such other party with respect to such future performance shall continue in full force and effect.

SECTION 33 – CONFLICTS OF INTEREST

Concessionaire covenants that it presently has no interest and shall not acquire any interest, direct or indirect, which would conflict in any manner or degree with the performance of its services hereunder. Concessionaire further covenants that in the performance of this Agreement no person having any conflicting interest shall be employed. Any interest on the part of Concessionaire or its employee must be disclosed to City.

SECTION 34 – POLITICAL ACTIVITIES

Concessionaire shall not engage in any political activities while in performance of any and all services and work under this Agreement.

SECTION 35 – ENTIRE AND SUPERSEDING AGREEMENT

This writing, all Exhibits hereto, and the other documents and agreements referenced herein, constitute the entire Agreement between the parties with respect to the subject matter hereof, and all prior agreements, correspondences, discussions and understandings of the parties (whether written or oral) are merged herein and made a

part hereof. This Agreement, however, shall be deemed and read to include and incorporate such minutes, approvals, plans, and specifications, as referenced in this Agreement, and in the event of a conflict between this Agreement and any action of City, granting approvals or conditions attendant with such approval, the specific action of City shall be deemed controlling.

SECTION 36 – AMENDMENT

This Agreement shall be amended only by formal written supplementary amendment. No oral amendment of this Agreement shall be given any effect. All amendments to this Agreement shall be in writing executed by both parties.

SECTION 37 – TIME COMPUTATION

Any period of time described in this Agreement by reference to a number of days includes Saturdays, Sundays, and any state or national holidays. Any period of time described in this Agreement by reference to a number of business days does not include Saturdays, Sundays or any state or national holidays. If the date or last date to perform any act or to give any notices is a Saturday, Sunday or state or national holiday, that act or notice may be timely performed or given on the next succeeding day which is not a Saturday, Sunday or state or national holiday.

SECTION 38 – NOTICES

NOTICES. Any notice, demand, certificate or other communication under this Agreement shall be given in writing and deemed effective: a) when personally delivered; b) three (3) days after deposit within the United States Postal Service, postage prepaid, certified, return receipt requested; or c) one (1) business day after deposit with a nationally recognized overnight courier service, addressed by name and to the party or person intended as follows:

To the City:	Killeen - Fort Hood Regional Airport Attn: Executive Director of Aviation 8101 S. Clear Creek Rd, Box C Killeen, TX 76549	Copy to: Attn. City Attorney City of Killeen 101 N. College St., 1 st Floor Killeen, TX 76541
--------------	--	---

To the Concessionaire: EAN Holdings, LLC d/b/a Enterprise Rent-A-Car
4210 South Congress Avenue
Austin, TX 78745

The parties may designate other addresses from time to time in writing. Concessionaire must provide a valid new address for notices within ten (10) days if the above address becomes invalid.

SECTION 39 – CONSTRUCTION

This Agreement shall be construed without regard to any presumption or rule requiring construction against the party causing such instrument to be drafted. This Agreement shall be deemed to have been drafted by the parties of equal bargaining strength. The captions appearing at the first of each numbered section of this Agreement are inserted and included solely for convenience but shall never be considered or given any effect in construing this Agreement with the duties, obligations, or liabilities of the respective parties hereto or in ascertaining intent, if any questions of intent should arise. All terms and words used in this Agreement, whether singular or plural and regardless of the gender thereof, shall be deemed to include any other number and any other gender as the context may require.

SECTION 40 – NO THIRD PARTY BENEFICIARY

Nothing contained in this Agreement, nor the performance of the parties hereunder, is intended to benefit, nor shall inure to the benefit of, any third party.

SECTION 41 – COMPLIANCE WITH LAW

The parties shall comply in all material respects with any and all applicable federal, state and local laws, regulations and ordinances.

SECTION 42 – FORCE MAJEURE

City shall not be responsible to Concessionaire and Concessionaire shall not be responsible to City for any resulting losses and it shall not be a default hereunder if the fulfillment of any of the terms of this Agreement is delayed or prevented by revolutions or other civil disorders, wars, acts of enemies, strikes, fires, floods, acts of God, adverse weather conditions, legally required environmental remedial actions, industry-wide shortage of materials, or by any other cause not within the control of the party whose performance was interfered with, and which exercise of reasonable diligence, such party is unable to prevent, whether of the class of causes hereinabove enumerated or not, and the time for performance shall be extended by the period of delay occasioned by any such cause.

SECTION 43 – GOOD STANDING

Concessionaire affirms that it is a company duly formed and validly existing and in good standing under the laws of the State of Texas and has the power and all necessary licenses, permits and franchises to own its assets and properties and to carry on its business. Concessionaire is duly licensed or qualified to do business and is in good standing in the State of Texas and in all other jurisdictions in which failure to do so would have a material adverse effect on its business or financial condition.

SECTION 44 – INDEPENDENT CONTRACTORS

The parties, their employees, agents, volunteers, and representative shall be deemed independent contractors of each other and shall in no way be deemed as a result of this Agreement to be employees of the other. The parties, their employees, agents, volunteers, and representatives are not entitled to any of the benefits that the other provides for its employees. The parties shall not be considered joint agents, joint ventures, or partners.

SECTION 45 – GOVERNMENTAL APPROVALS

Concessionaire acknowledges that various of the specific undertakings of City described in this Agreement may require approvals from the City of Killeen City Council, City of Killeen bodies, and/or other public bodies, some of which may require public hearings and other legal proceedings as conditions precedent thereto. Concessionaire further acknowledges that this Agreement is subject to appropriation by the Killeen City Council. City's obligation to perform under this Agreement is conditioned upon obtaining all such approvals in the manner required by law. City cannot assure that all such approvals will be obtained, however, it agrees to use good faith efforts to obtain such approvals on a timely basis.

SECTION 46 – AUTHORITY

The persons signing this Agreement warrant that they have the authority to sign as, or on behalf of, the party for whom they are signing.

SECTION 47 – COUNTERPARTS

This Agreement may be executed in one or more counterparts, all of which shall be considered but one and the same agreements and shall become effective when one or more counterparts have been signed by each of the parties and delivered to the other party.

SECTION 48 – SURVIVAL

All express representations, indemnifications and limitations of liability included in this Agreement will survive its completion or termination for any reason.

SECTION 49 – MORE FAVORABLE TERMS

In the event the City shall enter into any lease or agreement with any other rental car operator within the Airline Terminal building, that agreement will not contain more favorable terms than this Agreement, unless the same rights, privileges, and more favorable terms are concurrently made available to Concessionaire.

SECTION 50 – ENVIRONMENTAL

Subsection 50.1 Disposal, Use and Storage of Hazardous Materials. Disposal of Hazardous Materials on the Airport is strictly prohibited. Storage and use of Hazardous Materials on the Airport is prohibited, except:

- A. Concessionaire may store and use Hazardous Materials on the Leased Premises in a safe and prudent manner and in accordance with the requirements of all applicable Environmental Laws but only for those kinds and quantities of Hazardous Materials that are normally used in conducting the activities permitted under this Agreement. Storage shall be in an approved Hazardous Materials cabinet or storage container. Concessionaire shall provide Executive Director of Aviation with a copy of any application for a permit for use or storage of Hazardous Materials on the Leased Premises from any regulatory agency responsible for enforcement of Environmental Laws, and shall also a copy of any permit received from such agency; and
- B. Concessionaire may use Hazardous Materials on the Airport other than the Leased Premises only in a safe and prudent manner and in accordance with the requirements of all applicable Environmental Laws but only for those kinds and quantities of Hazardous Materials which are commonly used in conducting the activities permitted under this Agreement.

Subsection 50.2 Liability. Concessionaire shall be solely and fully responsible and liable for:

- A. Storage, use or disposal of Hazardous Materials on the Leased Premises or the Airport, by Concessionaire, Concessionaire's officers, agents, employees, or contractors,
- B. Any Hazardous Material release which is caused by or results from the activities of Concessionaire, Concessionaire's officers, agents, employees, or contractors on the Leased Premises or the Airport.

Subsection 50.3 Prevention of Release. Concessionaire shall take all necessary precautions to prevent its activities from causing any Hazardous Material release to occur on the Leased Premises or the Airport, including, but not limited to any release into soil, groundwater, or City's sewage or storm drainage system.

Subsection 50.4 Obligation to Investigate and Remediate. Concessionaire, at Concessionaire's sole cost and expense, shall promptly investigate and remediate, in accordance with requirements of all applicable Environmental Laws:

- A. Any release or threat of release of Hazardous Material on the Leased Premises or the Airport, including, but not limited to, into soil or groundwater, or City's sewage or storm drainage system which was caused or results in whole or in part from the activities of Concessionaire, Concessionaire's

officers, agents, employees, contractors, permittees or invitees; except that Concessionaire shall have no responsibility for any release or threat of release of Hazardous Material which Concessionaire establishes was caused by the sole negligence or willful misconduct of City, City's officers, agents, employees, contractors or permittees by any third party, or by migration of Hazardous Materials onto the premises from a specifically identifiable source off the use premises. In addition to all other rights and remedies of City hereunder, if Concessionaire does not promptly commence, and diligently pursue to remediate, to the extent required, any such release, or threat of release, of Hazardous Materials for which it has responsibility under this section, City, in its discretion, may pay to have same remediated and Concessionaire shall reimburse City plus a fifteen percent administration fee within fifteen (15) business days of City's demand for payment. The failure to commence investigation and provide City with a schedule for diligent completion of the remediation within thirty (30) days after discovery of such release, or threat of release, of Hazardous Material shall constitute prima facie evidence of failure to promptly commence remediation. The demand for payment by City shall be prima facie evidence that expense was incurred by City.

Subsection 50.5 Records and Inspections.

- A. Concessionaire will maintain a chemical inventory list and material safety data sheets of hazardous materials stored on site in accordance with state and federal regulations. The Concessionaire will also maintain manifests for all hazardous or regulated wastes transported and disposed of off-site.
- B. Upon reasonable notice by City, Concessionaire shall make available for review by City such records pertaining to the use, handling and disposal of any Hazardous Material(s) as Concessionaire is required to maintain under this section.
- C. City shall have the right, under the terms hereof, and upon reasonable notice for exclusive use space, to enter the Leased Premises during the Term hereof to conduct periodic environmental inspections and testing. City shall conduct each inspection or test in a manner that does not unreasonably interfere with Concessionaire's operations.

Subsection 50.6 Concessionaire Obligations upon Termination. Prior to vacating the Leased Premises, and in addition to all other requirements under this Agreement, Concessionaire shall remove any containers of Hazardous Materials placed on the Leased Premises during the Term by Concessionaire or as a result of Concessionaire's use or occupancy of the Leased Premises during the Term and shall demonstrate to City's reasonable satisfaction that such removal is in compliance with all applicable Environmental Laws, including without limitation conducting any environmental audits as may be required by City.

Subsection 50.7 Storm Water.

- A. Notwithstanding any other provisions or terms of this Agreement, Concessionaire acknowledges that certain properties within the Airport, or on City-owned land, are subject to storm water rules and regulations. Concessionaire agrees to observe and abide by such storm water rules and regulations as may be applicable to City's property and Concessionaire's uses thereof.
- B. Concessionaire acknowledges that any storm water discharge permit issued to City may name Concessionaire as a co-permittee. City and Concessionaire both acknowledge that close cooperation is necessary to insure compliance with any storm water discharge permit terms and conditions, as well as to insure safety and to minimize cost of compliance. Concessionaire acknowledges further that it may be necessary to undertake such actions to minimize the exposure of storm water to "significant materials" generated, stored, handled or otherwise used by Concessionaire, as such term may be defined by applicable storm water rules and regulations, by implementing and maintaining "best management practices" as that term may be defined in applicable storm water rules and regulations.
- C. City will provide Concessionaire with written notice of any storm water discharge permit requirements applicable to Concessionaire and with which Concessionaire will be obligated to comply from time-to-time, including, but not limited to: certification of non-storm water discharges; collection of storm water samples; preparation of storm water pollution prevention or similar plans; implementation of best management practices; and maintenance of necessary records. Such written notice shall include applicable deadlines. Concessionaire agrees that within thirty (30) days of receipt of such written notice it shall notify City in writing if it disputes any of the storm water permit requirements it is being directed to undertake. If Concessionaire does not provide such timely notice, Concessionaire will be deemed to assent to undertake such storm water permit requirements. In that event, Concessionaire agrees to undertake, at its sole expense, unless otherwise agreed to in writing between City and Concessionaire, those storm water permit requirements for which it has received written notice from City, and Concessionaire agrees that it will hold harmless and indemnify City for any violations or non-compliance with any such permit requirements.

SECTION 51 – ISRAEL CLAUSE

Concessionaire hereby verifies that it does not boycott Israel and will not boycott Israel during the term of this Agreement. Boycotting Israel is defined in Texas Government Code section 808.001 to mean refusing to deal with, terminating business activities with, or taking any action that is intended to penalize, inflict economic harm on, or limit commercial relations specifically with Israel, or with a person or entity doing business in Israel or in an Israeli-controlled territory, but does not include an action made for

ordinary business purposes.

IN WITNESS WHEREOF, the parties have executed this Agreement in duplicate on this ____ day of _____, 2018.

ATTEST:

CITY OF KILLEEN:

Lucy Aldrich
City Secretary

Ronald L. Olson
City Manager

ATTEST:

EAN Holdings, LLC

(name of signing authority)

(title)

EXHIBIT A1 - COUNTER/OFFICE/QUEUING AREAS

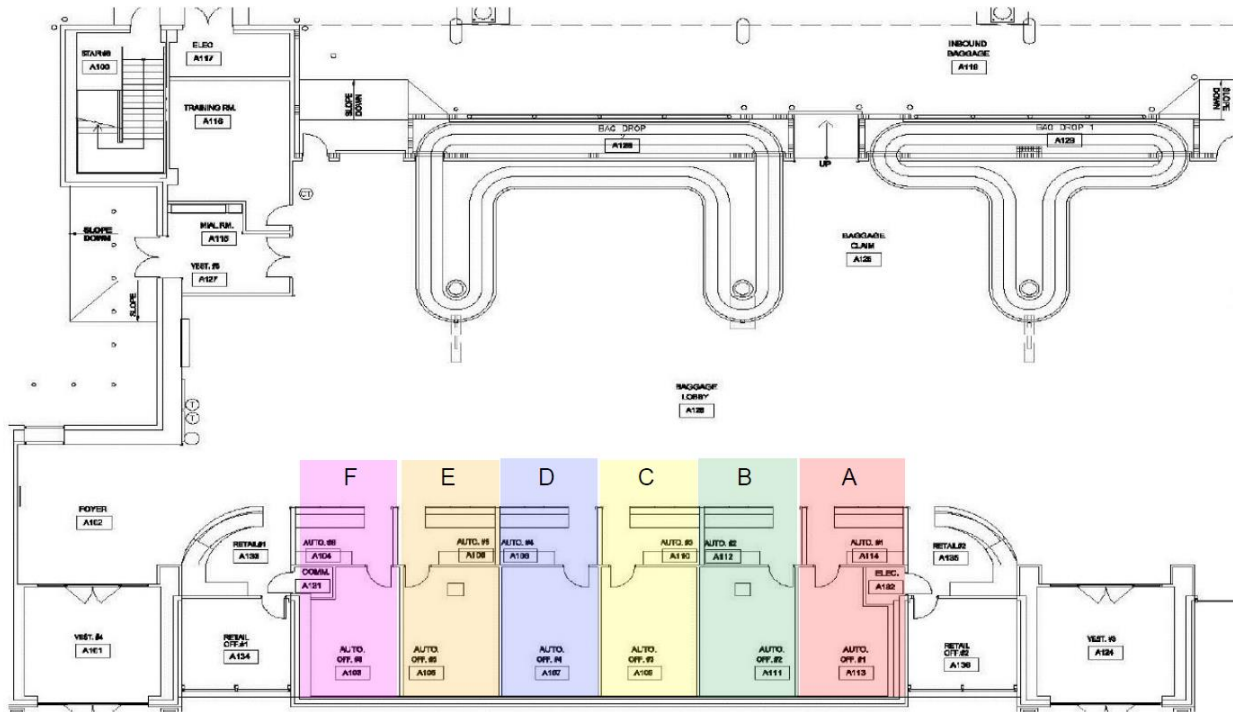

Space	Office	Counter Area	Queuing	Total Square Footage	Counter Length
A	199	107	102	408	12' 9"
B	232	109	103	444	12' 10"
C	232	109	103	444	12' 10"
D	232	109	103	444	12' 10"
E	232	109	103	444	12' 10"
F	199	104	102	405	12' 9"

REVISED EXHIBIT A2 - READY/RETURN BLOCKS AND SERVICE BAYS

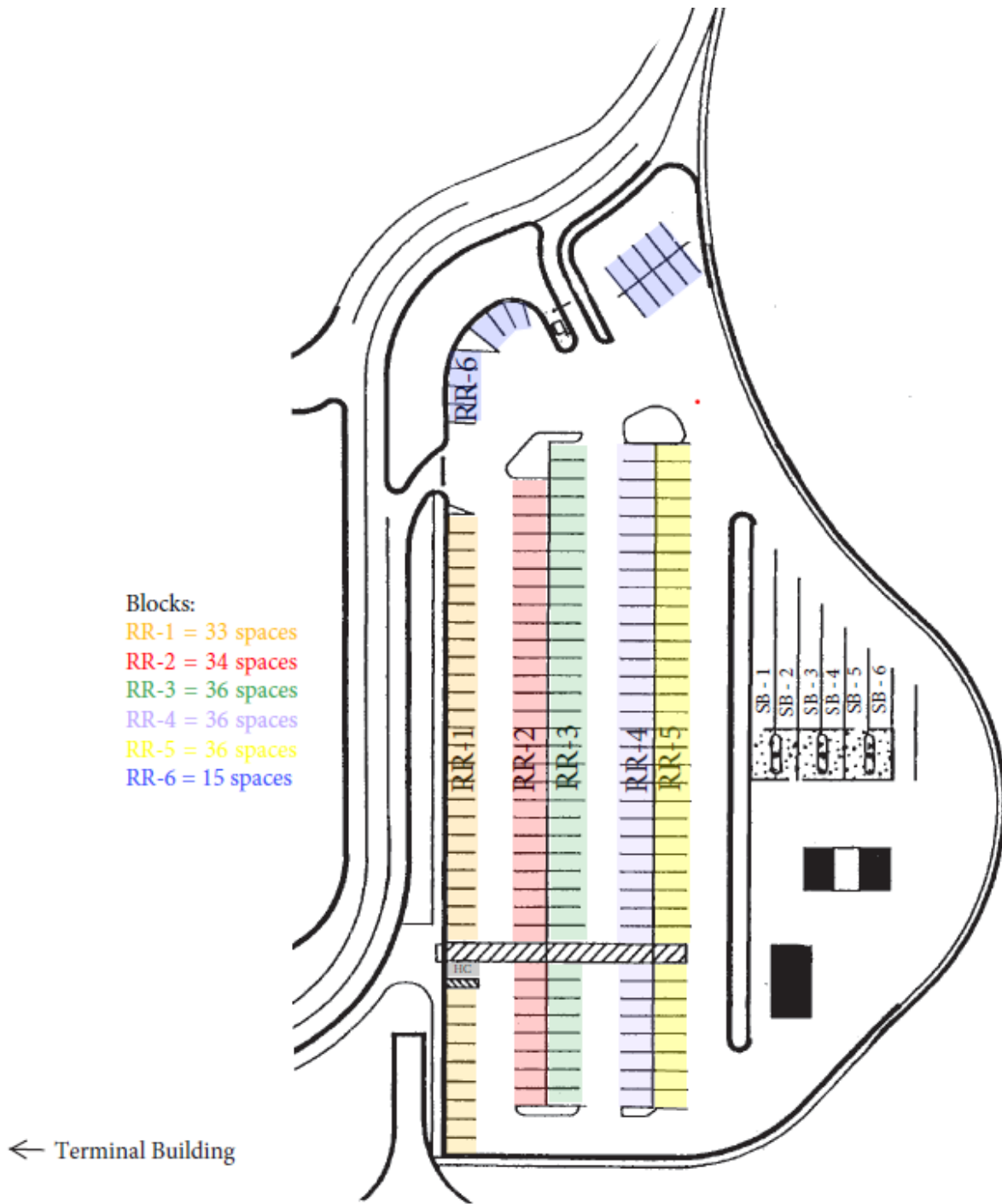

EXHIBIT A3 - STORAGE AREA

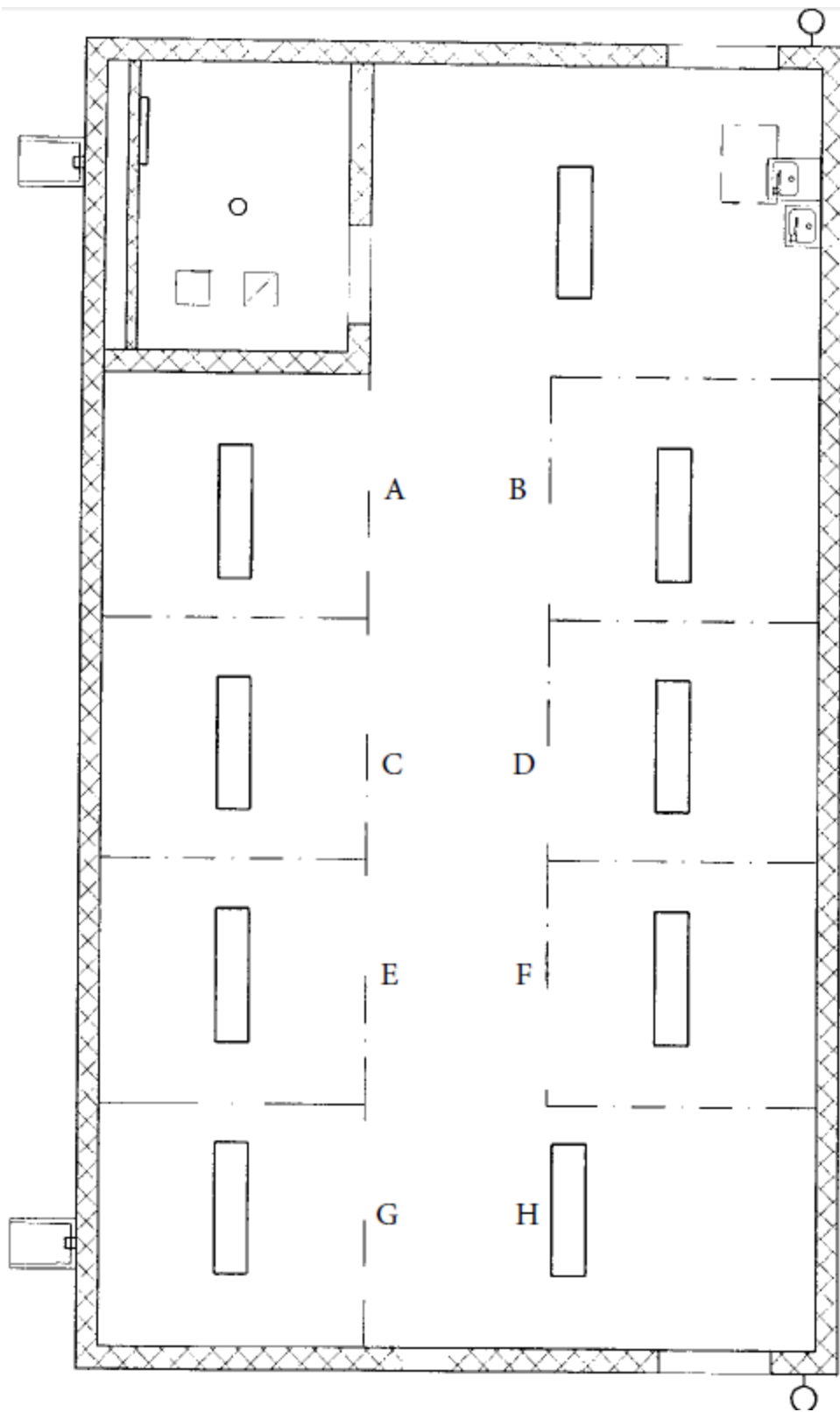

EXHIBIT A4 – OVERFLOW PARKING LANES

RENTAL CAR OVERFLOW PARKING LOT

27 - LANES
Each lane 8'6" x 85'

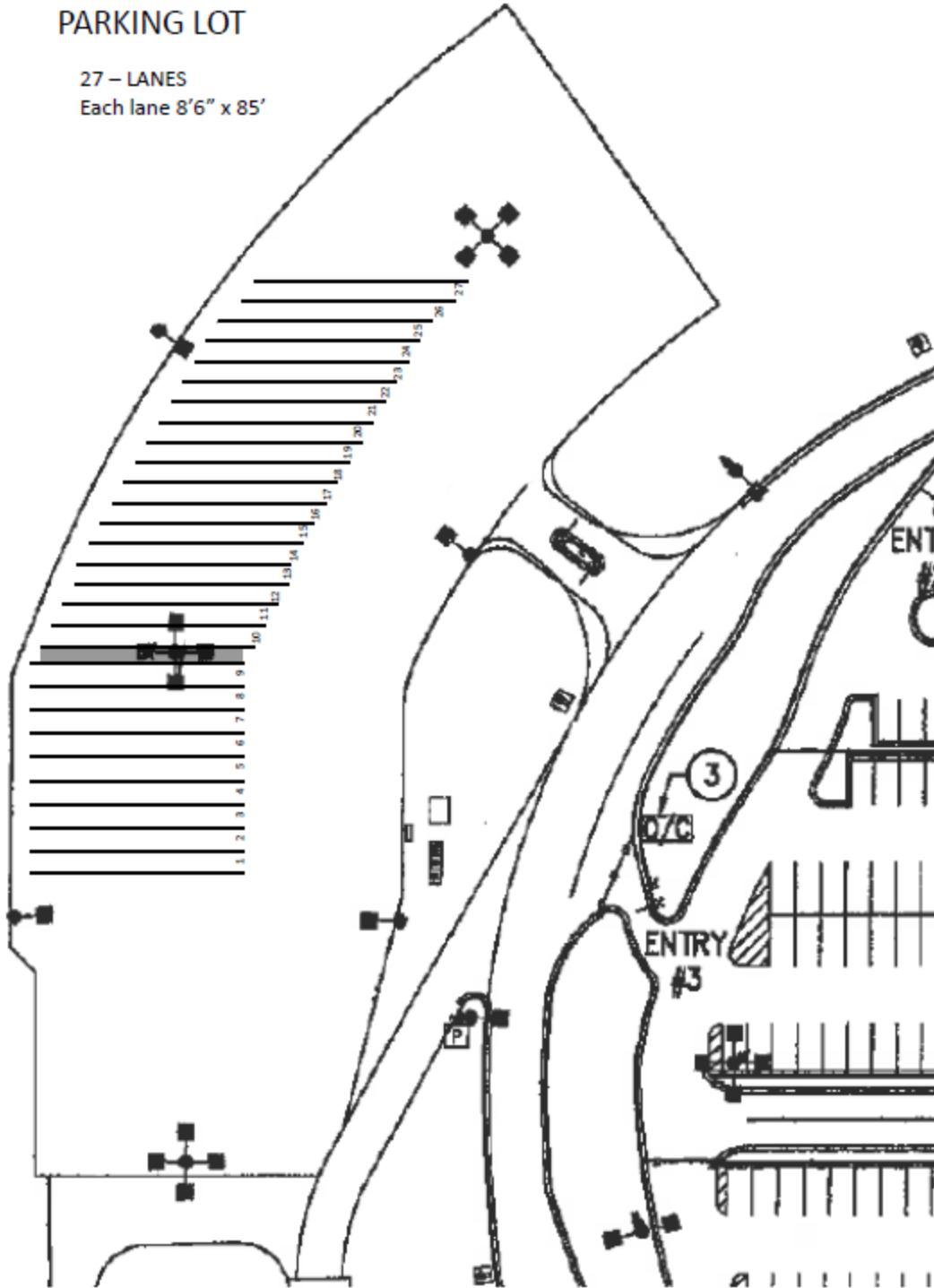

EXHIBIT B

KILLEEN – FORT HOOD REGIONAL AIRPORT
RENTAL CAR MONTHLY REPORT OF GROSS REVENUES
FOR MONTH OF _____

Concessionaire Name: _____

Address: _____

City, State, Zip: _____

Contact Name: _____

Phone # _____

GROSS RENTAL REVENUE: _____

Airport Fee (10%) _____

Less Monthly Guarantee paid 1st of month: _____

(1) Privilege Fee Balance Due: _____

Number of Transaction: _____

Number of Transaction Days: _____

(2) CFC Due (@ \$3.00 per Transaction Day): _____

Amount Due with this report (1) +(2): \$ _____

Concessionaire Official Signing and Certifying accuracy of Information on this report:

Signature _____

Typed Name & Title _____

Date signed _____

REMIT THIS FORM AND PAYMENT TO: City of Killeen Finance Department
Attn: Accounts Receivable
P.O. Box 1329
Killeen, TX 76540

CONCESSION AGREEMENT

NON-EXCLUSIVE RENTAL CAR CONCESSION
Killeen - Fort Hood Regional Airport
Killeen, Texas

between

Killeen - Fort Hood Regional Airport
City of Killeen, Texas

and

The Hertz Corporation

<u>Section</u>	<u>Page</u>
DEFINITIONS	6
SECTION 1 – LEASED PREMISES.....	8
SECTION 2 – TERM	9
SECTION 3 – USES, PRIVILEGES, COBRANDING AND OBLIGATIONS	9
SECTION 4 – RESTRICTIONS ON USES AND PRIVILEGES.....	11
SECTION 5 – PRIVILEGE FEE, RENTS, FEES AND ACCOUNTING RECORDS.....	11
Subsection 5.1 Privilege Fee, Rent and Fees.	11
Subsection 5.2 Statements, Books, and Records; Delinquent Rentals.	16
Subsection 5.3 Audit.....	17
SECTION 6 – INSTALLATION OF IMPROVEMENTS AND DESIGN, FURNISHING, AND EQUIPPING OF PREMISES	17
Subsection 6.1 Building Services	17
Subsection 6.2 Approval of Plans and Specifications; Provision of Drawings.....	17
SECTION 7 – TITLE TO IMPROVEMENTS, STRUCTURAL ALTERATIONS, ETC.	18
Subsection 7.1 Title.....	18
Subsection 7.2 Structural Alterations.....	19
Subsection 7.3 Alterations and Improvements to Airport.....	19
Subsection 7.4 Removal and Demolition.....	19
SECTION 8 – MAINTENANCE OF PREMISES	19
Subsection 8.1 Airport Maintenance Obligations.	19
Subsection 8.2 Concessionaire's Maintenance Obligations.	20
SECTION 9 – LIENS, PAYMENT, AND PERFORMANCE BONDS.....	21
Subsection 9.1 Construction Surety Bond.	21
Subsection 9.2.....	22
Subsection 9.3.....	22

SECTION 10 – OPERATION OF LEASED PREMISES: HOURS AND DELIVERIES	22
Subsection 10.1 Hours of Operation.....	22
Subsection 10.2 Delivery of Goods.	22
Subsection 10.3 Utilities.	22
 SECTION 11 – QUALITY AND CHARACTER OF SERVICE.....	23
Subsection 11.1 Type of Operation.	23
Subsection 11.2 Services to the General Public.....	23
Subsection 11.3 Additional Compliance.	23
Subsection 11.4 Personnel.....	23
 SECTION 12 – NON-DISCRIMINATION.....	24
 SECTION 13 – IDEMNIFICATION AND INSURANCE.....	24
Subsection 13.1 Indemnification.....	24
Subsection 13.2 Concessionaire to Provide General Liability and Automobile Insurance.	25
Subsection 13.3 Concessionaire to Provide Property and Fire Insurance.....	25
Subsection 13.4 Both Concessionaire and City to Carry Fire Insurance.	25
Subsection 13.5 Insurance Certificate.	26
Subsection 13.6 Concessionaire Failure to Provide Certificates.	26
 SECTION 14 – DAMAGE OR DESTRUCTION OF LEASED PREMISES	26
Subsection 14.1 Partial Damage.	26
Subsection 14.2 Extensive Damage.....	26
Subsection 14.3 Complete Destruction.	27
Subsection 14.4 Limits of City's Obligations Defined.....	27
 SECTION 15 – CANCELLATION.....	27
Subsection 15.1 Cancellation by Concessionaire.....	27
Subsection 15.2 Cancellation by City.	28
Subsection 15.3 Termination.	29
Subsection 15.4 Notice of Termination.....	29
 SECTION 16 – NONWAIVER OF RIGHTS.....	29
 SECTION 17 – SURRENDER OF POSSESSION	29
 SECTION 18 – TAXES AND LICENSES	29

SECTION 19 – INSPECTION OF PREMISES 30

SECTION 20 – HOLDING OVER 30

SECTION 21 – QUIET ENJOYMENT 30

SECTION 22 – NO LIENS..... 30

SECTION 23 – SECURITY AGREEMENTS 30

SECTION 24 – AGREEMENT SUBORDINATE TO AGREEMENTS WITH THE
UNITED STATES 30

SECTION 25 – RIGHTS AND PRIVILEGES OF CITY 31

SECTION 26 – ACCESS CONTROL 32

SECTION 27 – NO PERSONAL LIABILITY 33

SECTION 28 – GOVERNING LAW..... 33

SECTION 29 – NOTIFICATION 33

SECTION 30 – SEVERABILITY 34

SECTION 31 – ASSIGNMENT, SUBLET, AND TRANSFER 34

SECTION 32 – NO WAIVER 34

SECTION 33 – CONFLICTS OF INTEREST 34

SECTION 34 – POLITICAL ACTIVITIES..... 34

SECTION 35 – ENTIRE AND SUPERSEDING AGREEMENT 34

SECTION 36 – AMENDMENT	35
SECTION 37 – TIME COMPUTATION	35
SECTION 38 – NOTICES	35
SECTION 39 – CONSTRUCTION.....	35
SECTION 40 – NO THIRD PARTY BENEFICIARY	36
SECTION 41 – COMPLIANCE WITH LAW	36
SECTION 42 – FORCE MAJEURE.....	36
SECTION 43 – GOOD STANDING.....	36
SECTION 44 – INDEPENDENT CONTRACTORS	36
SECTION 45 – GOVERNMENTAL APPROVALS.....	37
SECTION 46 – AUTHORITY.....	37
SECTION 47 – COUNTERPARTS.....	37
SECTION 48 – SURVIVAL.....	37
SECTION 49 – MORE FAVORABLE TERMS.....	37
SECTION 50 – ENVIRONMENTAL.....	37
SECTION 51 – ISRAEL CLAUSE	40
EXHIBIT A1 - COUNTER/OFFICE/QUEUING AREAS	42
EXHIBIT A2 - READY/RETURN BLOCKS AND SERVICE BAYS	43

EXHIBIT A3 – STORAGE AREA..... 43

EXHIBIT A4 – OVERFLOW PARKING LANES..... 44

EXHIBIT B..... 45

RENTAL CAR CONCESSION
Killeen - Fort Hood Regional Airport
Killeen, Texas

THIS CONCESSION AGREEMENT ("**Agreement**"), made and entered into this 1st day of January, 2019, by and between the City of Killeen (the "**City**"), a municipal corporation and existing under the laws of the State of Texas, whose address is 8101 S. Clear Creek Rd, Box C, Killeen, Texas 76549, hereinafter referred to as "City" and "The Hertz Corporation" operating as Hertz, (hereinafter referred to as "**Concessionaire**"), a corporation with its office and address being 8501 Williams Road, Estero, FL 33928, with a mailing address of 8501 Williams Road, Estero, FL 33928.

WITNESSETH:

WHEREAS, City controls, owns, operates, and maintains an airport in the City of Killeen, County of Bell, State of Texas, known as Killeen - Fort Hood Regional Airport (hereinafter referred to as "Airport"), and has the power to grant rights and privileges with respect thereto, and

WHEREAS, the City has determined it to be in the best interests of the public and the City to enter into this Agreement with Concessionaire to provide rental car concession services at the Airport pursuant and subject to the terms and conditions hereunder,

NOW, THEREFORE, THE PARTIES AGREE:

DEFINITIONS

The following terms and phrases shall have the following meanings for purposes of this Agreement:

1. "ACDBE" shall mean airport concession disadvantaged business enterprise as that term is defined by 49 CFR Part 23.
2. "City" shall mean the municipal corporation existing under the laws of the State of Texas which controls, operates, and maintains the Killeen - Fort Hood Regional Airport.
3. "Environmental Law" shall mean any federal, state or local law, rule, regulation, order or requirement relating to protection of human health and safety or the environment.
4. "Executive Director of Aviation" shall mean the Executive Director of Aviation of the City's Airport, or his or her designee.
5. "Gross Revenues" as used herein shall mean, as determined in the reasonable discretion of the City, all amounts charged to its customers by Concessionaire for or in connection with agreements it secures through its operations and business at the

Airport, regardless of whether such amount is actually paid to or received by Concessionaire. Gross Revenues shall include all monies or other consideration of whatsoever nature paid or payable to Concessionaire by customers for all sales made and services performed for cash, credit or consideration in connection with automobile and vehicle rentals or other products or services provided to persons through Concessionaire's operations at the Airport, without regard to the ownership, area, fleet, or location assignment of vehicles and without regard to the manner in which or place at which the vehicles or other products or services are furnished to Concessionaire's customers and without regard to whether the vehicles or other products are returned to the Airport or to some other location.

Gross Revenues shall include anything and everything that is not specifically excluded. The only exclusions from Gross Revenues permitted under this Agreement shall be the specific exclusions set forth below:

- Federal, state, county, city or municipal sales, use, or excise taxes now in effect or hereinafter levied on Concessionaire's operations which are separately stated on customers' rental contracts and collected from customers of Concessionaire;
 - Those fees referred to in this Agreement as Customer Facility Charges, "CFCs" which for the purpose of this Agreement shall include all customer facility charges, authorized pursuant to City Resolution, as may be amended;
 - Amounts received specifically for the actual loss of or damages of vehicles or other property of Concessionaire;
 - Amounts received from the sale of vehicles off-Airport premises; provided, however, any amounts paid in connection with automobile and vehicle rentals or other products or services provided to persons through Concessionaire's operations that are applied to or otherwise reimbursed as a result of the sale of a vehicle shall not be excluded from Gross Revenues; and
 - Reimbursements for amounts actually paid for speeding tickets, parking tickets, red light tickets, tolls and toll violations, and towing and impound fees from its customers to pass through without markup to an independent third party with no amount being retained by Concessionaire. However, any amounts collected above the pass through amount shall be included as Gross Revenue under this Agreement.
6. "Hazardous Material" shall mean any material that, because of its quantity, concentration or physical or chemical characteristics, is deemed by any federal, state or local governmental authority to pose a present or potential hazard to human health or safety or to the environment, and includes any material or substance identified, listed, or defined as a "hazardous waste" "hazardous substance," or

“pollutant” or “contaminant” or term of similar import, or is otherwise regulated pursuant to Environmental Laws, including any asbestos and asbestos-containing materials; petroleum, including crude oil or any fraction thereof, natural gas or natural gas liquids.

7. "Leasehold Improvements" shall mean all improvements and equipment which are affixed to the Leased Premises and which cannot be removed without material damage to the Premises.
8. "Operations Year" shall mean January 1 through December 31 annually.
9. "Personal Property" shall mean all movable property of the Concessionaire not directly related to the rental car operations of the privileges granted hereunder, including, office furniture, office equipment, and office supplies.
10. "Refurbish" or "Refurbishment" shall mean the routine repainting or redecoration of public areas within the Leased Premises, as necessary, including the replacement or repair of worn carpet, tile, furniture, or furnishings.
11. "Rental Car" or "Motor Vehicles" shall mean motor vehicles designed primarily for the carriage of passengers and commonly classified as sedans, coupes, convertibles, station wagons, four-wheel drive vehicles, passenger vans, sport utility vehicles, and pick-up trucks rated one-ton or less. Concessionaire shall not park, store, or rent from Premises any vehicles except Motor Vehicles as defined herein that it owns or rents and are properly available for rental as provided herein.
12. "Terminal Building" shall mean the terminal building at the Airport.
13. "Trade Fixtures" shall mean all non-affixed items, except expendables and Personal Property, which can be removed without damage to the Leased Premises, including cash registers, safes, patron tables and chairs, display fixtures, and the like.
14. "Transaction" shall mean the execution of an agreement or contract for the rental of a Motor Vehicle; or, the payment of funds or completion of a cash or credit transaction for payment for rental of a Motor Vehicle; or delivery of a Motor Vehicle to a customer for use in exchange for cash, credit or any other consideration.
15. "Transaction Day" shall mean each twenty-four (24) hour period or portion thereof, for which a customer of a Rental Car concessionaire rents, or otherwise enters into a similar arrangement for the use of a Motor Vehicle and for which the Rental Car concessionaire collects revenue from the customer. Late returns (after twenty four (24) hours) shall be considered a Transaction Day.

SECTION 1 – LEASED PREMISES

A. City hereby leases to Concessionaire and Concessionaire hereby agrees to

lease from City the following premises, which, collectively, are hereinafter called the "Leased Premises": Four Hundred and Forty Four (444) square feet of counter/office/queuing area "C" in the terminal building, Block "RR-2" the ready return area containing approximately thirty-four (34) ready/return parking spaces outside and adjacent to the terminal building, Service Bay "1" and the associated queuing lane, and Storage Area "B". Said Leased Premises is more particularly shown on **Exhibits A1, A2, and A3** attached hereto and by this reference made a part hereof.

- B. Concessionaire agrees that its Leased Premises have been inspected by Concessionaire and are accepted and will be occupied by Concessionaire on an "as is" basis. The Concessionaire specifically waives any covenants or warranties regarding the Premises, including but not limited to any warranty of suitability and warranty of fitness.

SECTION 2 – TERM

The term of this Agreement is for a five (5) year period commencing on January 1, 2019 and terminating on December 31, 2023 unless sooner terminated or canceled as hereinafter provided.

SECTION 3 – USES, PRIVILEGES, COBRANDING AND OBLIGATIONS

Concessionaire shall have the following uses, privileges, and obligations in connection with its use of the Leased Premises:

- A. The non-exclusive right, privilege, and obligation to conduct and operate a rental car, van or truck rental concession at the Airport. Co-Branding by Concessionaire is limited to two brands per concession space specifically those listed in their submitted proposal. It being understood that no more than two brands under rental car agencies which are owned by the same parent company may operate from any one concession space during the term of this agreement. Concessionaire understands and agrees that it shall not engage in any other business on the Airport under this Agreement.
- B. The right, privilege, and obligation to rent and check-in rental vehicles, including the right to offer for sale related collision damage waiver protection, personal injury and accident insurance, personal effects insurance, and such other travel or vehicle related coverage offered in connection with and incidental to the rental of a vehicle and occupy operations office, storage, and Ready and Return car parking spaces. It is the intent of this Agreement that rental car customers of Concessionaire will operate the vehicle rented only from the ready spaces provided herein, and Concessionaire shall not engage in customer shuttle operations of any kind to, from, or on the Airport. This does not prohibit the picking up of a customer from the Fixed Base Operator (FBO). No trucks larger than ¾ ton pickup type/style will be allowed in the ready lot unless approved in writing in advance by the Executive Director of Aviation.

- C. The non-exclusive right and privilege to wash vehicles rented by Concessionaire under the provisions of this Agreement in the City's car wash.
- D. The right and privilege to service vehicles rented by the Concessionaire under the provisions of this Agreement in the service bay identified in Section 1. Concessionaire shall use the service bay for the following activities only: vehicle automated and hand washing, cleaning, fluid replacement, vacuuming, and related activities as are necessary for preparing its vehicles for rental. No washing or vehicle maintenance may be conducted in the rental car parking lot or overflow parking areas.
- E. The right of ingress and egress to and from the Premises, over Airport roadways, is subject to such reasonable rules and regulations as may be established by Airport as respecting such use and subject to law.
- F. Concessionaire shall install no signs on or about the Premises without the prior written approval of the Executive Director of Aviation, said approval being solely discretionary with the Executive Director of Aviation. For purposes of this Section, signs shall include, but not necessarily be limited to, identification signs, company logos, advertising or promotions, photographs, art displays, and the like. Such signs shall be substantially uniform in size, types and location with those of other concessionaries, and subject to Executive Director of Aviation's approval, Rules and Regulations, and in compliance with all applicable laws and resolutions. No temporary signs or displays shall be permitted on the backwall or the counter surfaces without the prior written approval of the Executive Director of Aviation. Handwritten, or hand lettered signs are prohibited. Concessionaire shall not place or install any racks, stands, trade fixtures, pedestal signs, or other displays of products outside the boundaries of the Leased Premises without the express prior written approval of the Executive Director of Aviation.
- G. The right for Concessionaire's employees, in common with other employees of tenants of the Terminal Building, to use vehicular parking space provided by City, subject to the payment of reasonable charges therefore, as set by the City.
- H. *Airport Concession Disadvantaged Business Enterprise Program*
 - 1. This agreement is subject to the requirements of the U.S. Department of Transportation's regulations, 49 CFR Parts 23 and 26 related to the airport concession disadvantaged business enterprises (ACDBE) program. The concessionaire or contractor agrees that it will not discriminate against any business owner because of the owner's race, color, national origin, or sex in connection with the award or performance of any concession agreement, management contract, or subcontract, purchase or lease agreement, or other agreement covered by 49 CFR Part 23.

2. The concessionaire or contractor agrees to include the above statements in any subsequent concession agreement or contract covered by 49 CFR Part 23, that it enters and cause those businesses to similarly include the statements in further agreements.
3. Each year Concessionaire no later than (90) days following end of each Operational Year shall provide to City the following annual ACDBE information: the name and address of each certified ACDBE with which it has done business during the past year, a description of the nature of the services performed by and/or items purchased from each firm named, and the dollar value of each transaction.

SECTION 4 – RESTRICTIONS ON USES AND PRIVILEGES

The Leased Premises shall be used only for the purposes specified in this Agreement. Concessionaire understands and agrees that City has the right to grant up to five additional privileges under separate agreements for in-terminal rental car operations to other companies.

Prohibited Activities at the service bay include:

- A. Concessionaire shall not utilize the service bay for vehicle storage other than vehicles for rent in the process of being serviced.
- B. Concessionaire shall not utilize the service bay for any maintenance or for the storage of damaged vehicles.
- C. Concessionaire shall not allow its customers or the general public to enter the service bay.
- D. Concessionaire shall not permit its employees to vacuum, wash or fuel their personal vehicles or vehicles not part of the Concessionaire's fleet at the service bay or fueling area.

SECTION 5 – PRIVILEGE FEE, RENTS, FEES AND ACCOUNTING RECORDS

Subsection 5.1 Privilege Fee, Rent and Fees.

- A. *Privilege Fee.* As consideration for the privilege of operating the concession hereunder, Concessionaire shall pay to City each contract year, for the full term of this Agreement, a Privilege Fee. Said Privilege Fee shall be the greater of either the guaranteed Minimum Annual Privilege Fee or the Percentage Fee applicable to Gross Revenue, hereinafter defined, as follows:
 1. Privilege Fee – the greater of either:
 - a. ten percent (10%) of the Concessionaire's annual Gross Revenues ("Percentage Privilege Fee");

OR

b. the respective yearly amount shown below as the Concessionaire's Minimum Annual Guaranteed fee ("MAG"):

January 1, 2019 to December 31, 2019	\$	<u>151,187.00</u>
January 1, 2020 to December 31, 2020	\$	<u>151,287.00</u>
January 1, 2021 to December 31, 2021	\$	<u>151,387.00</u>
January 1, 2022 to December 31, 2022	\$	<u>151,487.00</u>
January 1, 2023 to December 31, 2023	\$	<u>151,587.00</u>

2. Monthly payment shall be the greater of 1/12th of the respective year's MAG or 10% of reported gross revenues for the previous month. The MAG payment shall be paid in advance on the first (1st) day of each month during each Operations Year, until such time as the Concessionaire has paid to the Airport an amount equal to the respective annual MAG identified in Section 5.1(A)(1)(b) above. On or before the 20th of each month the Concessionaire shall provide the Airport with: i) a signed and certified Report of Gross Revenues for the preceding month and ii) payment of any percentage Privilege Fee shown to be due for the preceding month, as designated on Exhibit B, attached hereto and made a part hereof. Once the sum of Privilege Fee payments remitted has reached the MAG in any given Operations Year, the Concessionaire may cease remittance of the 1/12th of the respective year's MAG on the first (1st) day of each month for the remainder of that Operations Year. The Concessionaire shall continue to report and remit each and every month after the annual MAG has been reached the full 10% of reported gross revenues for the previous month.
3. In the event of a major traffic reduction at GRK, during the term of this Agreement, the MAG hereinabove provided for in this Section 5.1(A) above shall be abated for the period of time the condition exists. A major traffic reduction at GRK shall be defined as a twenty five percent (25%) reduction in the number of passengers deplaning on scheduled airline flights at GRK during any period of three (3) consecutive calendar months as compared to the number of such deplaning passengers in the same calendar months during the preceding calendar year.
4. Concessionaire acknowledges that Privilege Fee payments by Concessionaire to City under this Agreement are for Concessionaire's privilege to use the Airport facilities and access the Airport market and are not fees imposed by City upon Concessionaire's customers. City does not require, but will not prohibit, a separate statement of and charge for the Privilege Fee on customer invoices or rental agreements ("Recovery Fee"), provided that such Recovery Fee meets all of the following conditions: (a) such Recovery Fee must be titled "Concession Recovery Fee," "Concession Recoupment Fee" or such other name first approved

by the Executive Director of Aviation in writing; (b) the Recovery Fee must be shown on the customer rental car agreement and invoiced with other Concessionaire charges (i.e. “above the line”); (c) the Recovery Fee as stated on the invoice and charged to the customer shall be no more than 11.11% of Gross Revenues and shall be specifically included in the Definition of Gross Revenues for purposes of remittance to City; (d) Concessionaire shall neither identify, treat, or refer to the Recovery Fee as a tax, nor imply that City is requiring the pass through of such fee; (e) Concessionaire shall comply with all applicable laws, including Federal Trade Commission requirements, any Texas Consumer Protection legislation and any commitment to or contractual obligation by Concessionaire with any governmental agency or officer with authority over Concessionaire’s activities.

B. Rent -

1. Rent for Premises

Concessionaire shall pay to the City, in advance, on the 1st day of each month, one twelfth the following annual rents or the monthly rent as applicable:

- a) For the period commencing January 1, 2019 through December 31, 2019, Concessionaire shall pay the sum of Twenty-five Dollars and Thirty-two Cents (\$25.32) per square foot per annum for Four Hundred and Forty Four (444) square feet of counter/office/queuing position in the Terminal Building. On January 1 of each year for the period of this Agreement, commencing January 1, 2020, the rental amounts for the counter/office/queuing space, shall be adjusted in accordance with the Consumer Price Index – National Index for All Urban Consumers for the previous calendar year. Said adjustment shall be computed as follows:

$$\begin{aligned} &\text{Most recent year's rate x} \\ &\quad (\text{CPI for November of most recent year} / \\ &\quad \text{CPI for November of the next most recent year}) = \text{New Rate} \end{aligned}$$

- b) For the period commencing January 1, 2019 through December 31, 2019, Concessionaire shall pay the sum of Twenty-four Thousand Four Hundred and Eighty Dollars (\$24,480), per annum for Ready Return Block “RR-2” as shown on Exhibit A2. On January 1 of each year for the period of this Agreement, commencing January 1, 2020, the rental amounts for the parking block, shall be adjusted in accordance with the Consumer Price Index – National Index for All Urban Consumers for the previous calendar year, as described above.

- c) For the period commencing January 1, 2019 through December 31, 2019, Concessionaire shall pay the sum of Four Thousand Eight Hundred Dollars (\$4,800), per annum for service bay “1” as shown on Exhibit A2. On January 1 of each year for the period of this Agreement, commencing January 1, 2020, the rental amounts for the service bay, shall be adjusted in accordance with the Consumer Price Index – National Index for All Urban Consumers for the previous calendar year, as described above.
- d) For the period commencing January 1, 2019 through December 31, 2019, Concessionaire shall pay the sum of One Thousand Two Hundred Dollars (\$1,200), per annum for storage area “B” as shown on Exhibit A3. On January 1 of each year for the period of this Agreement, commencing January 1, 2020, the rental amounts for the storage area, shall be adjusted in accordance with the Consumer Price Index – National Index for All Urban Consumers for the previous calendar year, as described above.
- e) If requested by Concessionaire, overflow parking lanes as agreed upon with the Executive Director of Aviation on a month to month basis in the amount of \$150 per lane per month through December 31, 2019. On January 1 of each year for the period of this Agreement, commencing January 1, 2020, the rental amounts for the overflow parking lanes, shall be adjusted in accordance with the Consumer Price Index – National Index for All Urban Consumers for the previous calendar year, as described above. Overflow lanes are shown on Exhibit A4.

C. Additional Fees –

- 1. The Concessionaire shall collect the CFCs on behalf of the Airport and remit to the Airport, in accordance with the City’s CFC resolution, the full amount of the Transaction Day fee collected from each Rental Car customer.
- 2. The Concessionaire shall pay to the City for telephone system/service access to the Internet via a T-1 as follows:

Local service	\$23.50 per line per month
Voice mail	\$4.25 per line per month
Phone rental	\$6.00 per phone per month
Maintenance fee	\$15.50 per line per month

Above telecommunication fees are subject to change as determined by the City. Payment shall be due within thirty (30) days of invoice date.

3. The Concessionaire shall pay to the City a per wash fee of \$2.00 per automated wash. The Concessionaire shall pay to the City, for use of the manual car wash, a rate of \$1.25 per 5 minute session.

Car wash fees are subject to change as determined by the City with advance written notice. Payment shall be due within thirty (30) days of invoice date.

4. The Concessionaire shall pay to the City, based on actual gallons of fuel pumped, a per gallon fuel rate equal to the City's purchase price of the fuel plus \$0.15 cents, as may be adjusted by the City with advance written notice.

Payment shall be due within thirty (30) days of invoice date.

5. If the Concessionaire's bid reflected the operation of two brands in its concession, Concessionaire shall pay to the City a fee of One Thousand Dollars (\$1,000) per month which shall be paid in advance on the first (1st) of each month.
6. Additional fees may include charges for special items or activities including, but not limited to, employee parking, monthly electronic access card fees, badging fees, and disposal of debris left in service bay area and assigned parking areas. The City may assess reasonable, non-discriminatory and cost-recovery based charges for these special items or activities. All new charges will be reviewed with Concessionaire prior to implementation. Other charges payable by Concessionaire shall be paid by Concessionaire to City no later than thirty (30) days following receipt by Concessionaire of billing therefor.
7. Concessionaire shall be charged, at the current short term parking rate, for any of its vehicles found to be parked in a parking space not specifically leased by the Concessionaire or without the approval of the Executive Director of Aviation.

- D. Any and all payments due to the City by Concessionaire shall be remitted to the following address:

City of Killeen Finance Department
Attn: Accounts Receivable
P.O. Box 1329
Killeen, TX 76540

- E. Year End Adjustments to Privilege Fees, Rents and Fees.

In the event the amount of payments made during the preceding Operations Year exceeds the total of any payments due for such Operations Year, the

excess payment shall be credited against the payments for the next Operations Year, except that any excess payment during the final Operations Year of this Agreement will be returned to the Concessionaire within thirty (30) days after the Airport's acceptance of the final Certified Statement described in this Section. Concessionaire shall submit separate system generated reports for each brand name operated.

Subsection 5.2 Statements, Books, and Records; Delinquent Rentals.

- A. Monthly Statements; Books and Records. Within twenty (20) days after the close of each calendar month of the term of this Agreement, Concessionaire shall submit to City, in such detail and on the statement form designated as Exhibit B or as may reasonably be specified by City, certain information, including but not limited to, the number of Transactions executed during the preceding month, the number of Transaction Days Motor Vehicles were rented during the preceding month, and the statement of its Gross Revenues during the preceding month upon which the percentage payments to City set forth in Subsection 5.1 A(1) are to be computed, and said Exhibit B statement to be signed by a responsible accounting officer of Concessionaire. City reserves the right to change the form of the monthly statement and to require the submission by Concessionaire of other information pertaining to the Gross Revenues hereunder, and Concessionaire agrees to change the form of its statements to that requested by City and to provide any such additional information City may reasonably request. Concessionaire shall keep full and accurate books and records showing all of its Gross Revenues hereunder, and City shall have the right, through its representatives and at reasonable times, at its own expense, to inspect, examine, copy, and audit such books and records, including State of Texas sales tax return records. Concessionaire hereby agrees that all such books and records will be made available to City for at least three (3) years following the period covered by such books and records.
- B. Annual Certified Statements. Each year during the term of this Agreement, Concessionaire shall provide to City a written statement, certified by an independent Certified Public Accountant, to City stating that in his or her opinion the Percentage Fees paid by Concessionaire to City during the preceding year pursuant to this Agreement were made in accordance with the terms of this Agreement. Said statement shall be submitted by Concessionaire, to be received by City within ninety (90) days of the end of each contract year. Such statement shall also contain a list of the Gross Revenues, by month, as shown on the books and records of Concessionaire and which were used to compute the Percentage Fee payments made to City during the period covered by said statement.
- C. Delinquent Rentals and Fees. Without waiving any other right or action available to City in the event of default in the payment of charges or fees payable to City, pursuant to this Agreement, a late fee of one and a half percent (1.5%) of the total amount due will be assessed to the Concessionaire if payments

prescribed above are not received by the dates prescribed therein. An additional one and a half percent (1.5%) of the outstanding amount will be assessed each month that all or a portion of the Concessionaire's obligations remain unpaid.

Subsection 5.3 Audit. City reserves the right to audit Concessionaire's books and records pertaining to the Leased Premises, at its own expense, at any time for the purpose of verifying the Gross Revenues, Privilege Fee and CFC calculation hereunder for any period three (3) years prior to such audit. If, however, as a result of such audit, it is established that Concessionaire has understated the Gross Revenues received from all operations at the Leased Premises by two percent (2%) or more (after the deductions and exclusions herein), the entire expense of said audit shall be borne by Concessionaire. Any additional Privilege Fee due shall forthwith be paid by Concessionaire to City with interest thereon at one and one-half percent (1.5%) per month from the date such additional Privilege Fee became due.

SECTION 6 – INSTALLATION OF IMPROVEMENTS AND DESIGN, FURNISHING, AND EQUIPPING OF PREMISES

Subsection 6.1 Building Services

- A. City Improvements and Services. City shall initially insure and provide occupancy of the Leased Premises to Concessionaire with said Leased Premises meeting all federal, state and local code requirements for the operation of a rental car concession. City shall provide and maintain water, sewer, general lighting, electrical power, heating and air-conditioning, and telephone system/service access to the Internet via a T-1 for the Terminal Building. Heating and air conditioning, electrical service, and telephone system/service access to the Internet via T-1 are provided to the Leased Premises only. If Concessionaire requires additional lighting, electrical power, water, or adjustments to the air-conditioning system or telephone system, such additional improvements or services shall be subject to the prior written approval of Executive Director of Aviation, and any such approved improvements or services shall be made at Concessionaire's expense.
- B. Concessionaire's Right to Additional Services. Concessionaire shall have the right, at its own expense, to request and receive additional services or systems, provided that any such services or systems shall require the written approval of Executive Director of Aviation before installation.

Subsection 6.2 Approval of Plans and Specifications; Provision of Drawings.

- A. General. Any improvements to be made to or upon the Leased Premises by Concessionaire, and any subsequent alterations or additions to such improvements, shall be subject to the prior written approval of Executive Director of Aviation. Full and complete plans and specifications for all work, facilities, improvements, and finishes, and the time required to complete same, shall be submitted to and receive the written approval of Executive

Director of Aviation before any work or construction is commenced, which shall not be unreasonably withheld or delayed. First-class standards of design and construction shall be complied with in connection with all such work, facilities, and improvements; and all construction shall conform to the general architectural requirements of Executive Director of Aviation as established for each improvement program. Two (2) copies of plans for all improvements or subsequent changes therein or alterations thereof shall be given to Executive Director of Aviation for review prior to commencement of construction; after final approval by Executive Director of Aviation, Executive Director of Aviation shall return to Concessionaire one (1) approved copy for Concessionaire's records and shall retain one (1) approved copy as an official record thereof.

- B. Improvements Conform to Statutes, Ordinances, Etc. All improvements, furniture, fixtures, equipment, and finishes, including the plans and specifications therefore, constructed or installed by Concessionaire, its agents, or contractors, shall conform in all respects to applicable statutes, ordinances, building codes, and rules and regulations, and public bidding laws. Any approval given by City shall not constitute a representation or warranty as to such conformity; responsibility therefore shall at all times remain with Concessionaire.
- C. Approvals Extend to Architectural and Aesthetic Matters. Approval of City shall extend to and include architectural and aesthetic matters and City reserves the right to reasonably reject any layout or design proposals submitted and to require Concessionaire to resubmit any such layout or design proposals until they meet Executive Director of Aviation approval.
- D. Disapprovals. In the event of disapproval by City of any portion of any plans or specifications, Concessionaire shall promptly submit necessary modifications and revisions thereof for approval by Executive Director of Aviation. City agrees to act promptly upon such plans and specifications and upon requests for approval of changes or alterations in said plans or specifications. No substantial changes or alterations shall be made in said plans or specifications after initial approval by City, and no alterations or improvements shall be made to or upon the Leased Premises without the prior written approval of Executive Director of Aviation.
- E. Provision of As-Built Drawings. Upon completion of any construction project, Concessionaire shall provide City two (2) completed sets of as-built drawings in reproducible form as specified by City. Concessionaire agrees that, upon the request of City, Concessionaire will inspect the Leased Premises jointly with City to verify the as-built drawings.

SECTION 7 – TITLE TO IMPROVEMENTS, STRUCTURAL ALTERATIONS, ETC.

Subsection 7.1 Title. All improvements made to the Leased Premises by

Concessionaire, and any additions and alterations thereto made by Concessionaire, shall be and remain the property of Concessionaire until the termination of this Agreement (whether by expiration of the term, cancellation, forfeiture or otherwise), at which time said improvements, except for Trade Fixtures, personal property, and expendables, shall become the property of City, at no cost to City.

Subsection 7.2 Structural Alterations. Concessionaire shall make no structural alterations to the Leased Premises without the prior written consent of Executive Director of Aviation.

Subsection 7.3 Alterations and Improvements to Airport. Concessionaire acknowledges that from time to time City may undertake construction, repair, or other activities related to the operation, maintenance and repair of the Terminal Building which may temporarily affect Concessionaire's operations hereunder. Concessionaire agrees to accommodate City in such matters, even though Concessionaire's own activities may be inconvenienced, and Concessionaire agrees that no liability shall attach to City, its members, employees, or agents by reason of such inconvenience or impairment. It is agreed that in the event such activities of City substantially impair the operations of Concessionaire under this Agreement, the Minimum Privilege Fee shall be waived during such period of substantial impairment, with what constitutes "substantial impairment" being reasonably determined by Executive Director of Aviation after consultation with Concessionaire. Concessionaire agrees that if relocation is required that Concessionaire shall move its operations as reasonably directed by Executive Director of Aviation.

Subsection 7.4 Removal and Demolition. Concessionaire shall not remove or demolish, in whole or in part, any Leasehold Improvements upon the Leased Premises without the prior written consent of City which may, at its sole discretion, condition such consent upon the obligation of Concessionaire, at Concessionaire's cost, to replace the same by an improvement specified in such consent.

SECTION 8 – MAINTENANCE OF PREMISES

Subsection 8.1 Airport Maintenance Obligations.

- A. General Maintenance and Operation. City agrees that it will, with reasonable diligence, maintain, operate, and keep in good repair the Airport, including the Terminal Building and all appurtenances, facilities, and services now or hereafter connected therewith. Airport shall keep the car rental parking lot and the overflow parking area in suitable repair, and provide general lighting for these areas.
- B. Structural Maintenance. City shall provide, or cause to be provided, structural maintenance of the Terminal Building.
- C. Maintain Access. City shall, throughout the term of this Agreement, maintain all airport-owned roads on the Airport giving access to the Terminal Building

in good and adequate condition for use by cars and trucks and shall maintain free and uninterrupted access to the Terminal Building over said road at all times. City reserves the right to reasonably restrict access to the Terminal Building area for automobile deliveries during peak activity periods.

- D. Car Wash. City will maintain and inspect the car wash facilities as recommended by the manufacturer including routine maintenance of the car wash for normal activities, wear and tear. Normal and routine maintenance of roofs, walls, utility infrastructure, building mechanical systems and structural building components will be performed by City. Wash soaps, rinses, brushes, hoses, and utilities will be provided by the City. City has the exclusive authority to stop the use of the car wash for maintenance and inspections as is necessary, at City's sole discretion, without damage or liability to Concessionaire. City will take reasonable action to notify Concessionaire for closure of the car wash.
- E. Telephone System/Service Access to the Internet via a T-1. The Airport shall furnish telephone system/service access to the Internet via a T-1. Rates for these services will be in accordance with Section 5.1(C). A letter of agreement or other suitable document will be executed between the Airport's Executive Director of Aviation or his/her designated representative and the local designated representative of the Concessionaire to document exactly which services are agreed to between the two parties. Airport reserves the right to change or terminate said telephone and/or internet service at some point during the term of this Agreement. Airport will provide at least a ninety (90) day notice to Concessionaire of any service changes and assist in facilitating replacement services via a local communication provider.

Subsection 8.2 Concessionaire's Maintenance Obligations.

- A. Concessionaire's General Obligations. Except for maintenance of the Terminal Building, Car Wash, and Telephone System, as provided in Subsection 8.1, Concessionaire shall be obligated, without cost to City, to maintain the Leased Premises and every part thereof in good appearance, repair, and safe condition. Concessionaire shall maintain and repair all Leasehold Improvements on the Leased Premises and all furnishings, fixtures, and equipment therein, whether installed by Concessionaire or by others, including repainting or redecorating as necessary, and replacing or repairing worn carpet, tile, fixtures, or furnishings. All such maintenance and repairs shall be at least of quality equal to the original in materials and workmanship, and all work, including paint colors, shall be subject to the prior written approval of Executive Director of Aviation. Concessionaire shall be obligated, without cost to City, to provide custodial service to Leased Premises. Concessionaire shall be responsible for the replacement cost of lost keys and floor finish restoration.
- B. Hazardous Conditions. Upon discovery, Concessionaire shall immediately

give oral notice to Airport of any hazardous or potentially hazardous conditions in the Leased Premises or in the Terminal Building. Any hazardous or potentially hazardous condition in the Leased Premises shall be corrected immediately upon receipt of oral notice from the Executive Director of Aviation. At the direction of said Director, Concessionaire shall close the Leased Premises until such hazardous or potentially hazardous condition is removed.

- C. **Trash and Refuse.** City shall provide, at no cost to Concessionaire, a container for the adequate sanitary handling of all trash and other refuse caused as a result of the operation of the Leased Premises. Concessionaire shall be responsible for disposal of its own trash accumulations by depositing it in the nearest exterior trash dumpster on a daily basis. Concessionaire will regularly inspect exterior areas assigned to them and will remove all trash and debris. Failure to do so will result in the City completing this task and a fee assessed to the Concessionaire for the service. Trash receptacles inside the terminal building are for customer use only. Piling of boxes, cartons, barrels, or other similar items in view of a public area is prohibited. Concessionaire shall keep any areas used for trash and garbage storage prior to removal from Airport in a reasonably clean and orderly condition so as not to unduly attract rodents, pests, or birds, or create an offensive odor. Concessionaire also agrees to participate in the City's recycling program by depositing all recyclable products in the appropriate outside recycling containers in lieu of the trash dumpster.
- D. **Transporting Trash and Refuse.** In transporting trash and refuse from the Leased Premises, Concessionaire shall ensure that trash is not strewn around while taking refuse to the dump site. Such disposal shall take place during hours as may be approved by the City.
- E. **Damage to Equipment.** Concessionaire will be responsible for the cost of replacement equipment deemed to be damaged by their employees due to negligence.

SECTION 9 – LIENS, PAYMENT, AND PERFORMANCE BONDS

Subsection 9.1 Construction Surety Bond. Concessionaire shall not allow any liens or encumbrances to be attached to the Leased Premises. Prior to the commencement of any construction or alteration hereunder which exceeds \$10,000 in cost, Concessionaire or its contractor shall furnish to City, and without expense to City, a surety bond, issued by a surety company licensed to transact business in the State of Texas and satisfactory to and approved by City with Concessionaire's contractor or contractors as principals, in a sum not less than one hundred percent (100%) of the total cost of the contract or contracts for the construction or alteration of the improvements and facilities mentioned herein. Said bond shall guarantee the prompt payment to all persons supplying labor, materials, provisions, supplies, and equipment used directly or indirectly by said

contractor, subcontractor(s), and suppliers in the prosecution of the work provided for in said construction contract and shall protect City from any liability, losses, or damages arising there from.

Subsection 9.2 Compliance with Federal Aviation Regulations, 14 CFR Part 139, and Transportation Security Administration security requirements 49 CFR Part 1542. Concessionaire agrees to comply with Federal Aviation Regulations, and 1542 (Airport Security), U.S. Army requirements, and the City's policies as outlined in City's approved Operations Plan and Airport Security Plan. Concessionaire further agrees that any fines levied upon the City or Concessionaire through enforcement of these regulations because of acts by Concessionaire's employees, agents, suppliers, guests, or patrons shall be borne by Concessionaire to the extent said acts contributed to said fines.

Subsection 9.3 Security. During the term of this Agreement, the City shall require the Operator to deliver (and thereafter maintain current for the entire term of this Agreement) an instrument of security in a form satisfactory to the City, in its sole discretion, in the amount of twenty-five percent (25%) of Concessionaire's Minimum Annual Guarantee for each year hereunder, in order to secure the performance of all of Concessionaire's obligations under this Agreement, including without limitation, the payment of all the percentages, minimums, fees, charges and costs set out herein. Said security may be in the form of a bond.

SECTION 10 – OPERATION OF LEASED PREMISES: HOURS AND DELIVERIES

Subsection 10.1 Hours of Operation. Concessionaire shall actively operate in the Leased Premises and shall use a business-like operation therein. The Concessionaire shall be open to serve the public seven (7) days per week and hours of operation shall be such that passengers of flights arriving or departing from the terminal will be accommodated. In no event shall the hours of operation be curtailed to an extent that the service contemplated under this Agreement shall be diminished. Except as otherwise stated herein, the hours of service shall be determined in light of changing public demands and airline operating schedules. Concessionaire may advise the Executive Director of Aviation of Concessionaire's analysis of the optimum arrangements, but the final determination shall be made by the Executive Director of Aviation based on their analysis of necessary service to the public.

Subsection 10.2 Delivery of Goods. Concessionaire shall arrange for the timely delivery of all motor vehicles and supplies, at such times, in such locations(s), and by such routes as determined by City. Concessionaire shall abide by all Transportation Security Administration (TSA) requirements for parking of motor vehicles near the terminal building.

Subsection 10.3 Utilities.

A. City shall provide the Leased Premises with heat and air-conditioning to keep

the Leased Premises at reasonable temperatures for the conduct of Concessionaire's activities. City shall have the right to set, monitor, adjust and restrict thermostat settings to levels it determines to be appropriate.

- B. City shall provide electricity to the Leased Premises by means of wiring installations, and Concessionaire shall make such connections as required and permitted by building code. At no time shall Concessionaire's use of electric current exceed the capacity of the wiring installation in place.

SECTION 11 – QUALITY AND CHARACTER OF SERVICE

Subsection 11.1 Type of Operation. Concessionaire shall maintain and operate the concession privileges granted hereunder in an orderly, proper, and first-class manner, which, in the sole judgment of Executive Director of Aviation, does not unduly annoy, disturb, or offend others at the Airport.

Subsection 11.2 Services to the General Public. Concessionaire understands and agrees that its operation at the Airport necessitates the rendering of public services such as giving directions, and generally assisting the public.

Subsection 11.3 Additional Compliance. Concessionaire shall comply with all applicable governmental laws, ordinances, and regulations in the conduct of its operations under this Agreement.

Subsection 11.4 Personnel.

- A. General. Concessionaire shall maintain a sufficient number of properly trained personnel to ensure that all customers of Concessionaire receive prompt and courteous service. All such personnel, while on or about the Leased Premises, shall be polite, clean, appropriately attired, and neat in appearance. Clothing will be neat and clean and present a professional appearance. Executive Director of Aviation shall have the right to object to the demeanor, conduct, and appearance of any employee of Concessionaire, or any of its invitees or those doing business with it, whereupon Concessionaire shall take all steps necessary to remedy the cause of the objection. Concessionaire will ensure that its counter is staffed at all times during the posted hours of operation.
- B. Manager. The management, maintenance, and operation of the Leased Premises and the concession conducted thereon shall be at all times during the term hereof under the supervision and direction of an active, qualified, competent, and experienced manager, who shall at all times be authorized to represent and act for Concessionaire. Concessionaire shall cause such manager to be available during normal business hours, and Concessionaire will at all times during the absence of such manager assign, or cause to be assigned, a qualified subordinate to assume and be directly responsible for the carrying out of his or her duties.

SECTION 12 – NON-DISCRIMINATION

This agreement is subject to the requirements of the U.S. Department of Transportation's regulations, 49 CFR Part 23, pursuant to law, it is unlawful and Concessionaire agrees not to willfully refuse to employ, to discharge, or to discriminate against any person otherwise qualified because of race, color, religion, sex, sexual orientation, age, disability, national origin or ancestry, lawful source of income, marital status, creed, or familial status; not to discriminate for the same reason in regard to tenure, terms, or conditions of employment, not to deny promotion or increase in compensation solely for these reasons; not to adopt or enforce any employment policy which discriminates between employees on account of race, color, religion, sex, creed, age, disability, national origin or ancestry, lawful source of income, marital status or familial status; not to seek such information as to any employee as a condition of employment; not to penalize any employee or discriminate in the selection of personnel for training, solely on the basis of race, color, religion, sex, sexual orientation, age, disability, national origin or ancestry, lawful source of income, marital status, creed or familial status.

Concessionaire shall include or cause to be included in each subcontract covering any of the services to be performed under this Agreement a provision similar to the above paragraph, together with a clause requiring such insertion in further subcontracts that may in turn be made.

SECTION 13 – IDEMNIFICATION AND INSURANCE

Subsection 13.1 Indemnification. To the fullest extent allowable by law, Concessionaire hereby indemnifies and shall defend and hold harmless, at Concessionaire's expense, City, its elected and appointed officials, committee members, officers, employees or authorized representatives or volunteers, from and against any and all suits, actions, legal or administrative proceedings, claims, demands, damages, liabilities, losses, interest, attorney's fees (including in-house counsel legal fees), costs and expenses of whatsoever kind, character or nature whether arising before, during, or after completion of the Agreement hereunder and in any manner directly or indirectly caused or contributed to in whole or in part, by reason of any act, omission, fault, or negligence, whether active or passive of Concessionaire, or of anyone acting under its direction or control or on its behalf in connection with or incident to the performance of this Agreement, regardless if liability without fault is sought to be imposed on City. Concessionaire's aforesaid indemnity and hold harmless agreement shall not be applicable to any liability caused by the negligent or willful misconduct of City, its elected and appointed officials, officers, employees or authorized representatives or volunteers. Nothing in this Agreement shall be construed as City waiving its statutory limitation and/or immunities as set forth in the applicable Texas Statutes or other applicable law. This indemnity provision shall survive the termination or expiration of this Agreement.

Concessionaire shall reimburse City, its elected and appointed officials, officers,

employees or authorized representatives or volunteers for any and all legal expenses and costs incurred by each of them in connection therewith or in enforcing the indemnity herein provided. Concessionaire's obligation to indemnify shall not be restricted to insurance proceeds, if any, received by City, its elected and appointed officials, officers, employees or authorized representatives or volunteers.

To the extent allowed by law, except for damage or injury caused by the willful or negligent act or omission of Concessionaire, its agents or employees, City shall indemnify, defend and save Concessionaire, its agents, representatives, and employees from any and all lawsuits, claims, loss and damages of any nature whatsoever, including damage to property of any Concessionaire and the injury, including death, of employees, agents, or customers of Concessionaire, arising either directly or indirectly out of any operations of the City hereunder, except lawsuits, claims, loss and damages arising out of the sole negligence of the Concessionaire, their employees, or agents.

Subsection 13.2 Concessionaire to Provide General Liability and Automobile Insurance. Concessionaire shall, at its sole expense, obtain and maintain in effect at all times during this Agreement the following insurance coverage:

- A. Commercial General Liability Insurance of not less than \$5,000,000 per occurrence for bodily injury, personal injury and property damage;
- B. Automobile Insurance of not less than \$5,000,000 per occurrence;
- C. To the extent that Concessionaire employs any employees or as otherwise required by law, Workers' Compensation and Employers' Liability Insurance with Texas statutory limits.

Subsection 13.3 Concessionaire to Provide Property and Fire Insurance. Concessionaire, at its own expense, shall insure all Leasehold Improvements and furnishings, fixtures and equipment for fire, extended coverage, vandalism, and malicious mischief. Such insurance shall be in an amount equal to the full insurable replacement value of such improvements. All property insurance policies shall contain loss payable endorsements in favor of the parties as their respective interests may appear hereunder and shall contain a waiver of subrogation provision in favor of the City. Concessionaire and City agree that any payments received by either from such insuring companies by reason of loss under such policy or policies shall be applied toward repair and reconstruction of said Leasehold Improvements and repair or replacement of leasehold improvements, furnishings, fixtures and equipment.

Subsection 13.4 Both Concessionaire and City to Carry Fire Insurance. It is understood that both Concessionaire and City carry insurance in the form of fire, extended coverage, vandalism, and malicious mischief (hereinafter called "Insurance Coverage") on the leased structural part of the premises, permanent improvements and loss of income, (in the case of City) and on Leasehold Improvements, furniture, furnishings, equipment, inventory and loss of income, (in the case of Concessionaire), and said Insurance Coverage authorizes a waiver of subrogation between City and

Concessionaire, and the parties wish to enter into such waiver of subrogation to the extent of the said Insurance Coverage; therefore, to the extent that City collects under its Insurance Coverage, City waives any and all claims against Concessionaire, its agents, servants, and employees, for loss or damage to City's property resulting from risks included in said Insurance Coverage; and, to the extent that Concessionaire collects under its Insurance Coverage, Concessionaire waives any and all claims against City, its agents, servants, and employees, for loss or damage to Concessionaire's property resulting from risks included in said Insurance Coverage. If this waiver by the parties shall render fully any such insurance policy or shall result in the denial of coverage for a party under such policy, then the provision paragraph shall be deemed to be null and void.

Subsection 13.5 Insurance Certificate. A certificate evidencing insurance required by Subsection 13.2 and 13.3, and listing the City of Killeen as additional insured, excluding Workers' Compensation and Property and Fire Insurance, shall be filed with City prior to the commencement of construction, furnishing and equipping of Leasehold Improvements by Concessionaire upon the Leased Premises, and such certificate shall provide that such Insurance Coverage will not be canceled or reduced without at least thirty (30) days prior written notice to City. Prior to the expiration of any such policy, a certificate showing that such Insurance Coverage has been renewed shall be filed with City. If such Insurance Coverage is canceled or reduced, Concessionaire shall within fifteen (15) days after receipt of written notice from City of such cancellation or reduction in coverage, file with City a certificate showing that the required insurance has been reinstated or provided through another insurance company or companies.

Subsection 13.6 Concessionaire Failure to Provide Certificates. In the event that Concessionaire shall at any time fail to furnish City with the certificate or certificates required under this Section, City, upon written notice to Concessionaire of its intention so to do, shall have the right to obtain the required insurance, at the cost and expense of Concessionaire, and Concessionaire agrees to promptly reimburse City for the cost thereof, plus fifteen percent (15%) thereof for administrative overhead.

SECTION 14 – DAMAGE OR DESTRUCTION OF LEASED PREMISES

Subsection 14.1 Partial Damage. If all or a portion of the Leased Premises is partially damaged by fire, explosion, the elements, public enemy, or other casualty, but not rendered untenable, the same will be repaired with due diligence by City subject to the limitations of Subsection 14.4; provided, however, to the extent that such damage or destruction is not covered by insurance, Concessionaire shall be responsible for reimbursing City for the cost and expenses insured in such repair to the extent that the damage is caused by the negligent act or omission of Concessionaire, its sublessees, agents, or employees.

Subsection 14.2 Extensive Damage. If the damages referred to in Subsection 14.1 shall be so extensive as to render the Terminal Building Premises untenable, but capable of being repaired in thirty (30) days, the same shall be repaired with due

diligence by City subject to the limitations of Subsection 14.4; and the charges payable herein for the MAG and Rent under Section 5.1 shall abate from the time of such damage or destruction until such time as the said Leased Premises are fully restored and certified by City's Engineers as ready for occupancy; provided, however, the said fees and charges will not abate and to the extent that such damage or destruction is not covered by insurance, Concessionaire shall be responsible for reimbursing City for the cost and expenses incurred in such repair to the extent that the damage is caused by the negligent act or omission of Concessionaire, its sublessees, agents, or employees.

Subsection 14.3 Complete Destruction. In the event the Terminal Building Premises are completely destroyed by fire, explosion, the elements, the public enemy, or other casualty, or so damaged that they are untenable and cannot be replaced for more than thirty (30) days, City shall undertake the repair, replacement, and reconstruction of said Leased Premises; and charges payable herein for the MAG and Rent under Section 5.1, shall abate as of the time of such damage or destruction until such time as the said Premises are fully restored and certified by City's Executive Director of Aviation as ready for occupancy; provided, however, the said fees and charges will not abate and to the extent that such damage or destruction is not covered by insurance, Concessionaire shall be responsible for reimbursing City for the costs and expenses incurred in said repair to the extent that the damage is caused by the negligent act or omission of Concessionaire, its sublessees, agents, or employees; provided further, however, if within twelve (12) months after the time of such damage or destruction said Leased Premises shall not have been repaired or reconstructed, Concessionaire may cancel this Agreement in its entirety. Rents payable for the leased areas in the Terminal Building and/or Ready/Return Block will only abate if the City is unable to provide alternative space for Concessionaire to conduct its business.

Subsection 14.4 Limits of City's Obligations Defined. It is understood that, in the application of the foregoing Subsections, City's obligations shall be limited to repair or reconstruction of the Leased Premises to the same extent and of equal quality as obtained at the commencement of operations hereunder, subject to funding and appropriation. Redecoration and replacement of furniture, fixtures, equipment, and supplies shall be the responsibility of Concessionaire and any such redecoration and refurbishing/re-equipping shall be of equivalent quality to that originally installed hereunder.

SECTION 15 – CANCELLATION

Subsection 15.1 Cancellation by Concessionaire. Concessionaire may cancel this Agreement and terminate all its obligations hereunder upon or after the happening of one or more of the following events and provided that Concessionaire is not in default in the payment of any fees or charges to City:

- A. The abandonment of the Airport as an airline terminal or the removal of all certificated passenger airline service from the Airport for a period of no less than thirty (30) consecutive days.

- B. The inability of Concessionaire to use the Airport for a period of longer than ninety (90) days, because of the issuance of any order, rule, or regulation by any competent governmental authority or court having jurisdiction over Concessionaire or City, preventing Concessionaire from operating its business; provided, however, that such inability or such order, rule, or regulation is not primarily due to any fault of Concessionaire.
- C. The material breach by City in the performance of any covenant or agreement herein required to be performed by City and the failure of City to remedy such breach for a period of sixty (60) days after receipt from Concessionaire of written notice to remedy the same.

Subsection 15.2 Cancellation by City. City may cancel this Agreement and terminate all of its obligations hereunder at any time that City is not in default, upon or after the happening of any of the following events:

- A. Concessionaire shall file a voluntary petition in bankruptcy; or
- B. Proceedings in bankruptcy shall be instituted against Concessionaire and Concessionaire is thereafter adjudicated bankrupt pursuant to such proceedings; or
- C. A court shall take jurisdiction of Concessionaire and its assets pursuant to proceedings brought under the provisions of any federal reorganization act; or
- D. A receiver of Concessionaire's assets shall be appointed; or
- E. Concessionaire voluntarily abandons its conduct of its business at the Airport for a period of thirty (30) days, except if such is due to a labor strike or labor dispute in which Concessionaire is involved; or
- F. Any assignment is made by Concessionaire for the benefit of its creditors; or
- G. The material breach by Concessionaire of any of the covenants or agreements herein contained and the failure of Concessionaire to remedy such breach as hereinafter provided. In this regard it is understood that nonpayment of fees or charges hereunder is a material breach. In the event of such material breach, City shall give to Concessionaire notice in writing to correct such breach and if such breach shall continue for fifteen (15) days after the receipt of such notice by Concessionaire, City may, after the lapse of said fifteen (15) day period, cancel this Agreement, without forfeiture, waiver, or release of City's rights to any sum of money due or to become due under the provisions of this Agreement.
- H. The lawful assumption by the United States Government, or any authorized agency thereof, of the operation, control or use of the Airport and facilities, or any substantial part or parts thereof, in such manner as to substantially

restrict Concessionaire, for a period of at least thirty (30) days, from its Airport operation.

Subsection 15.3 Termination. Should an early termination of this Agreement occur pursuant to the terms of Subsection 15.2 hereof, City shall have the right to re-enter the Leased Premises, make repairs as necessary, and enter into another agreement for the Leased Premises and privileges, or any part thereof, for the remainder of the term hereof.

Subsection 15.4 Notice of Termination. If any of the events enumerated in Subsections 15.1 and 15.2 shall occur and after due notice the defaulting party has failed to cure or correct same, the complaining party may, at any time thereafter during the continuance of said default, terminate this Agreement by notice in writing, such cancellation and termination to be effective upon the date specified in such notice.

SECTION 16 – NONWAIVER OF RIGHTS

Continued performance by either party hereto pursuant to the terms of this Agreement after a default of any of the terms, covenants, and conditions herein contained to be performed, kept, or observed by the other party hereto shall not be deemed a waiver of any right to cancel this Agreement for any subsequent default; and no waiver of any such default shall be construed or act as a waiver of any subsequent default.

SECTION 17 – SURRENDER OF POSSESSION

Concessionaire shall, upon termination of this Agreement or cancellation, quit and deliver up the Leased Premises and privileges to City peaceably and quietly, with the Leased Premises being in as good order and condition as the same now are or may be hereafter improved by Concessionaire or City, reasonable use and wear thereof excepted. In addition to any lien provided by Texas law, City shall have a specific lien on all property of Concessionaire, and related equipment on the Leased Premises as security for nonpayment. Concessionaire shall have the right to remove all of its trade fixtures and equipment installed or placed by it at its own expense, in, on or about the Premises; subject however, to any valid lien which City may have thereon for unpaid charges or fees. Provided however, the City will not claim or have a lien of any kind, be it contractual or statutory, on or against Concessionaire's motor vehicles for non-payment of any rent or fees due under the Agreement, or for any default of Concessionaire or any other reason, and the City hereby waives all such liens available to the City.

SECTION 18 – TAXES AND LICENSES

Concessionaire shall obtain and pay for all licenses or permits necessary or required by law for the construction of improvements, the installation of equipment and furnishings, and any other licenses necessary for the conduct of its operations hereunder.

SECTION 19 – INSPECTION OF PREMISES

City or its duly authorized representatives, or agents, and other persons for it, may enter upon said Leased Premises at any and all reasonable times during the term of this Agreement for the purpose and conditions hereof or for any other purpose incidental to rights of City.

SECTION 20 – HOLDING OVER

Should Concessionaire holdover said Leased Premises after this Agreement has terminated in any manner, Concessionaire shall continue such holding over only at sufferance to City. In the event of such holding over, Concessionaire shall pay to the City the amounts specified in Subsection 5.1, the amounts being the amounts in effect immediately prior to the commencement of such holdover.” All other terms and conditions in such holdover shall be the same as herein provided.

SECTION 21 – QUIET ENJOYMENT

City agrees that Concessionaire, upon payment of the fees and charges and all other payments to be paid by Concessionaire under the terms of this Agreement, and upon observing and keeping the agreements and covenants of this Agreement on the part of Concessionaire to be observed and kept, shall lawfully and quietly hold, occupy, and enjoy the Leased Premises during the term of this Agreement.

SECTION 22 – NO LIENS

Concessionaire shall pay for all labor done or materials furnished in the repair, replacement, development, or improvement of the Premises by Concessionaire, and shall keep said Leased Premises and Concessionaire's possessory interest therein free and clear of any lien or encumbrance of any kind whatsoever created by Concessionaire's act or omission.

SECTION 23 – SECURITY AGREEMENTS

City shall provide, or cause to be provided, during the term of this Agreement, all proper and appropriate public fire and police protection similar to that afforded to other Landside tenants or licensees at the Airport, and it will issue and enforce rules and regulations with respect thereto for all portions of the Airport. Concessionaire shall comply with the Airport Security Plan and shall have the right, but shall not be obligated, to provide such additional or supplemental public protection as it may desire, but such right, whether or not exercised by Concessionaire, shall not in any way be construed to limit or reduce the obligations of City hereunder.

SECTION 24 – AGREEMENT SUBORDINATE TO AGREEMENTS WITH THE UNITED STATES

This Agreement is subject and subordinate to the terms, reservations, restrictions, and

conditions of any existing or future agreements between the City and the United States, the execution of which has been or may be required as a condition precedent to the transfer of federal rights or property to the City for Airport purposes, and the expenditure of federal funds for the extension, expansion, or development of the Killeen - Fort Hood Regional Airport. Should the effect of such Agreement with the United States government be to take any of the property under lease or substantially destroy the commercial value of such improvements, City shall terminate this Agreement.

SECTION 25 – RIGHTS AND PRIVILEGES OF CITY

- A. City shall have the right to enforce, and adopt from time to time, reasonable rules and regulations, which Concessionaire agrees to observe and obey, with respect to the use of the Airport, Airport Terminal Building and appurtenances, provided that such rules and regulations shall not be inconsistent with safety, current rules and regulations of the FAA, and any future changes prescribed from time to time by the FAA.
- B. The City Manager or designee is hereby designated as its official representative for the enforcement of all provisions in this Agreement with full power to represent City with dealings with Concessionaire in connection with the rights herein granted.
- C. All actions relating to policy determination, modification of this Agreement, termination of this contract, and any similar matters affecting the terms of this Agreement shall emanate from the City Council, their successors or assigns.
- D. The Executive Director of Aviation or designee may enter upon the Leased Premises, now or hereafter leased to Concessionaire hereunder, at any reasonable time, for any purpose necessary, incidental to, or connected with, the performance of its obligations hereunder, or in the exercise of its governmental functions.
- E. City reserves the right to further plan, develop, improve, remodel and/or reconfigure the Airport, including the Leased Premises and existing vehicle and pedestrian traffic patterns, as the City deems appropriate, regardless of the desires or views of Concessionaire, and without interference or hindrance.
- F. City hereby reserves for the use and benefit of the public, the right of aircraft to fly in the airspace overlying the land herein leased, together with the right of said aircraft to cause such noise as may be inherent in the operation of aircraft landing at, taking off from, or operating on or in the vicinity of Killeen - Fort Hood Regional Airport, and the right to pursue all operations of the Killeen - Fort Hood Regional Airport.
- G. City reserves the right to take any action it considers necessary to protect the aerial approaches of the Airport against obstruction, together with the right to prevent Concessionaire from erecting, or permitting to be erected, any

building or other structure on the Airport, which, in the opinion of the City, would limit the usefulness of the Airport, or constitute a hazard to aircraft.

- H. City may from time to time increase the size or capacity of any such Public Aircraft Facilities or Passenger Terminal Building or Common Use Portion of the Airport or make alterations thereto or reconstruct or relocate them or modify the design and type of construction thereof or close them or any portions of them, either temporarily or permanently, provided notice is given to Concessionaire.
- I. This Agreement at any time may be reopened for renegotiation if Federal Aviation Administration (FAA) Airport Certification (FAR Part 139), Transportation Security Administration (TSA) Security Requirements (49 CFR, Part 1542), or U.S. Army regulations result in major expenditures to City due to Concessionaire's tenancy on the Killeen - Fort Hood Regional Airport. If said renegotiation is desired, written notice must be given to Concessionaire sixty (60) days prior to such renegotiations.
- J. City reserves the right to relocate the Leased Premises upon the completion of any Terminal area remodeling or expansion. City will not be liable for the costs associated with the moving or reinstallation of Concessionaire's equipment. In the event the City requires a move by the Concessionaire, the City will reimburse actual out-of-pocket costs associated with the relocation as approved in advance subject to a maximum amount as established by the City.

SECTION 26 – ACCESS CONTROL

- A. Concessionaire shall upon termination of this agreement return all issued keys and access cards to City. If all issued keys and access cards are not returned to City at the termination of this Agreement Concessionaire shall pay to City cost to re-core premises locks and cut new keys at the rate set at the time of such re-core and to pay for any lost access cards.
- B. Concessionaire is responsible for all keys and access cards issued to employees of Concessionaire. Concessionaire is responsible to insure every employee that has regular duty at the Airport is submitted for airport electronic access cards appropriate for that employee and that all employee data remains current. The Concessionaire will notify the appropriate representative of the Airport by telephone or other appropriate means as soon as possible following the termination of any employee, but will do so in writing no later than the end of the next working day after the employee's last day of employment at the Airport. The Concessionaire is further responsible for returning the employee's electronic access cards no later than three (3) working days after the last day of employment at the Airport. Any lost electronic access cards must be reported in writing to the Airport's representative as soon as possible, but no later than the end of the next

working day from the date of the loss. Concessionaire is responsible for any charges or damages incurred by the use of electronic access cards issued to its employees unless more than 24 hours (excluding weekends and City of Killeen recognized holidays) have passed from the time the Concessionaire provides written notification to the Airport's representative to cancel any access these electronic access cards allow. A monthly fee will be charged for active employee electronic access cards and for lost cards at the current rates adopted by the City.

- C. Concessionaire may not install additional locks or change locks to Leased Premises without the written approval of the Executive Director of Aviation.

SECTION 27 – NO PERSONAL LIABILITY

Under no circumstances shall any trustee, officer, official, commissioner, Director, member, partner or employee of City have any personal liability arising out of this Agreement, and Concessionaire shall not seek or claim any such personal liability.

SECTION 28 – GOVERNING LAW

This Agreement and all questions and issues arising in connection herewith shall be governed by and construed in accordance with the laws of the State of Texas. Venue for any action arising out of or in any way related to this Agreement shall be exclusively in Bell County, Texas. Each party waives its right to challenge venue.

SECTION 29 – NOTIFICATION

Concessionaire shall:

- A. As soon as possible and in any event within a reasonable period of time after the occurrence of any default, notify City in writing of such default and set forth the details thereof and the action which is being taken or proposed to be taken by Concessionaire with respect thereto.
- B. Promptly notify City of the commencement of any litigation or administrative proceeding that would cause any representation and warranty of Concessionaire contained in this Agreement to be untrue.
- C. Notify City, and provide copies, immediately, upon receipt, of any notice, pleading, citation, indictment, complaint, order or decree from any federal, state or local government agency or regulatory body, asserting or alleging a circumstance or condition that requires or may require a financial contribution by Concessionaire or any guarantor or an investigation, clean-up, removal, remedial action or other response by or on the part of Concessionaire or any guarantor under any environmental laws, rules, regulations, ordinances or which seeks damages or civil, criminal or punitive penalties from or against Concessionaire or any guarantor for an alleged violation of any environmental

laws, rules, regulations or ordinances.

SECTION 30 – SEVERABILITY

The provisions of this Agreement are severable. If any provision or part of this Agreement or the application thereof to any person or circumstance shall be held by a court of competent jurisdiction to be invalid or unconstitutional for any reason, the remainder of this Agreement and the application of such provision or part thereof to other persons or circumstances shall not be affected thereby.

SECTION 31 – ASSIGNMENT, SUBLET, AND TRANSFER

Concessionaire shall not assign, sublet, or transfer its interests or obligations under the provisions of this Agreement without the prior written consent of City, which shall not be unreasonably withheld or delayed. This Agreement shall be binding on the heirs, successors, and assigns of each party hereto. Concessionaire shall provide not less than forty-five (45) days advance written notice of any intended assignment, sublet or transfer.

SECTION 32 – NO WAIVER

The failure of any party to insist, in any one or more instance, upon performance of any of the terms, covenants, or conditions of this Agreement shall not be construed as a waiver, or relinquishment of the future performance of any such term, covenant, or condition by any other party hereto but the obligation of such other party with respect to such future performance shall continue in full force and effect.

SECTION 33 – CONFLICTS OF INTEREST

Concessionaire covenants that it presently has no interest and shall not acquire any interest, direct or indirect, which would conflict in any manner or degree with the performance of its services hereunder. Concessionaire further covenants that in the performance of this Agreement no person having any conflicting interest shall be employed. Any interest on the part of Concessionaire or its employee must be disclosed to City.

SECTION 34 – POLITICAL ACTIVITIES

Concessionaire shall not engage in any political activities while in performance of any and all services and work under this Agreement.

SECTION 35 – ENTIRE AND SUPERSEDING AGREEMENT

This writing, all Exhibits hereto, and the other documents and agreements referenced herein, constitute the entire Agreement between the parties with respect to the subject matter hereof, and all prior agreements, correspondences, discussions and understandings of the parties (whether written or oral) are merged herein and made a

part hereof. This Agreement, however, shall be deemed and read to include and incorporate such minutes, approvals, plans, and specifications, as referenced in this Agreement, and in the event of a conflict between this Agreement and any action of City, granting approvals or conditions attendant with such approval, the specific action of City shall be deemed controlling.

SECTION 36 – AMENDMENT

This Agreement shall be amended only by formal written supplementary amendment. No oral amendment of this Agreement shall be given any effect. All amendments to this Agreement shall be in writing executed by both parties.

SECTION 37 – TIME COMPUTATION

Any period of time described in this Agreement by reference to a number of days includes Saturdays, Sundays, and any state or national holidays. Any period of time described in this Agreement by reference to a number of business days does not include Saturdays, Sundays or any state or national holidays. If the date or last date to perform any act or to give any notices is a Saturday, Sunday or state or national holiday, that act or notice may be timely performed or given on the next succeeding day which is not a Saturday, Sunday or state or national holiday.

SECTION 38 – NOTICES

NOTICES. Any notice, demand, certificate or other communication under this Agreement shall be given in writing and deemed effective: a) when personally delivered; b) three (3) days after deposit within the United States Postal Service, postage prepaid, certified, return receipt requested; or c) one (1) business day after deposit with a nationally recognized overnight courier service, addressed by name and to the party or person intended as follows:

To the City: Killeen - Fort Hood Regional Airport
Attn: Executive Director of Aviation
8101 S. Clear Creek Rd, Box C
Killeen, TX 76549

Copy to: Attn. City Attorney
City of Killeen
101 N. College St., 1st Floor
Killeen, TX 76541

To the Concessionaire: The Hertz Corporation
8501 Williams Road
Estero, FL 33928

The parties may designate other addresses from time to time in writing. Concessionaire must provide a valid new address for notices within ten (10) days if the above address becomes invalid.

SECTION 39 – CONSTRUCTION

This Agreement shall be construed without regard to any presumption or rule requiring

construction against the party causing such instrument to be drafted. This Agreement shall be deemed to have been drafted by the parties of equal bargaining strength. The captions appearing at the first of each numbered section of this Agreement are inserted and included solely for convenience but shall never be considered or given any effect in construing this Agreement with the duties, obligations, or liabilities of the respective parties hereto or in ascertaining intent, if any questions of intent should arise. All terms and words used in this Agreement, whether singular or plural and regardless of the gender thereof, shall be deemed to include any other number and any other gender as the context may require.

SECTION 40 – NO THIRD PARTY BENEFICIARY

Nothing contained in this Agreement, nor the performance of the parties hereunder, is intended to benefit, nor shall inure to the benefit of, any third party.

SECTION 41 – COMPLIANCE WITH LAW

The parties shall comply in all material respects with any and all applicable federal, state and local laws, regulations and ordinances.

SECTION 42 – FORCE MAJEURE

City shall not be responsible to Concessionaire and Concessionaire shall not be responsible to City for any resulting losses and it shall not be a default hereunder if the fulfillment of any of the terms of this Agreement is delayed or prevented by revolutions or other civil disorders, wars, acts of enemies, strikes, fires, floods, acts of God, adverse weather conditions, legally required environmental remedial actions, industry-wide shortage of materials, or by any other cause not within the control of the party whose performance was interfered with, and which exercise of reasonable diligence, such party is unable to prevent, whether of the class of causes hereinabove enumerated or not, and the time for performance shall be extended by the period of delay occasioned by any such cause.

SECTION 43 – GOOD STANDING

Concessionaire affirms that it is a company duly formed and validly existing and in good standing under the laws of the State of Texas and has the power and all necessary licenses, permits and franchises to own its assets and properties and to carry on its business. Concessionaire is duly licensed or qualified to do business and is in good standing in the State of Texas and in all other jurisdictions in which failure to do so would have a material adverse effect on its business or financial condition.

SECTION 44 – INDEPENDENT CONTRACTORS

The parties, their employees, agents, volunteers, and representative shall be deemed independent contractors of each other and shall in no way be deemed as a result of this Agreement to be employees of the other. The parties, their employees, agents,

volunteers, and representatives are not entitled to any of the benefits that the other provides for its employees. The parties shall not be considered joint agents, joint venturers, or partners.

SECTION 45 – GOVERNMENTAL APPROVALS

Concessionaire acknowledges that various of the specific undertakings of City described in this Agreement may require approvals from the City of Killeen City Council, City of Killeen bodies, and/or other public bodies, some of which may require public hearings and other legal proceedings as conditions precedent thereto. Concessionaire further acknowledges that this Agreement is subject to appropriation by the Killeen City Council. City's obligation to perform under this Agreement is conditioned upon obtaining all such approvals in the manner required by law. City cannot assure that all such approvals will be obtained, however, it agrees to use good faith efforts to obtain such approvals on a timely basis.

SECTION 46 – AUTHORITY

The persons signing this Agreement warrant that they have the authority to sign as, or on behalf of, the party for whom they are signing.

SECTION 47 – COUNTERPARTS

This Agreement may be executed in one or more counterparts, all of which shall be considered but one and the same agreements and shall become effective when one or more counterparts have been signed by each of the parties and delivered to the other party.

SECTION 48 – SURVIVAL

All express representations, indemnifications and limitations of liability included in this Agreement will survive its completion or termination for any reason.

SECTION 49 – MORE FAVORABLE TERMS

In the event the City shall enter into any lease or agreement with any other rental car operator within the Airline Terminal building, that agreement will not contain more favorable terms than this Agreement, unless the same rights, privileges, and more favorable terms are concurrently made available to Concessionaire.

SECTION 50 – ENVIRONMENTAL

Subsection 50.1 Disposal, Use and Storage of Hazardous Materials. Disposal of Hazardous Materials on the Airport is strictly prohibited. Storage and use of Hazardous Materials on the Airport is prohibited, except:

- A. Concessionaire may store and use Hazardous Materials on the Leased Premises in a safe and prudent manner and in accordance with the requirements of all applicable Environmental Laws but only for those kinds and quantities of Hazardous Materials that are normally used in conducting the activities permitted under this Agreement. Storage shall be in an approved Hazardous Materials cabinet or storage container. Concessionaire shall provide Executive Director of Aviation with a copy of any application for a permit for use or storage of Hazardous Materials on the Leased Premises from any regulatory agency responsible for enforcement of Environmental Laws, and shall also a copy of any permit received from such agency; and
- B. Concessionaire may use Hazardous Materials on the Airport other than the Leased Premises only in a safe and prudent manner and in accordance with the requirements of all applicable Environmental Laws but only for those kinds and quantities of Hazardous Materials which are commonly used in conducting the activities permitted under this Agreement.

Subsection 50.2 Liability. Concessionaire shall be solely and fully responsible and liable for:

- A. Storage, use or disposal of Hazardous Materials on the Leased Premises or the Airport, by Concessionaire, Concessionaire's officers, agents, employees, or contractors,
- B. Any Hazardous Material release which is caused by or results from the activities of Concessionaire, Concessionaire's officers, agents, employees, or contractors on the Leased Premises or the Airport.

Subsection 50.3 Prevention of Release. Concessionaire shall take all necessary precautions to prevent its activities from causing any Hazardous Material release to occur on the Leased Premises or the Airport, including, but not limited to any release into soil, groundwater, or City's sewage or storm drainage system.

Subsection 50.4 Obligation to Investigate and Remediate. Concessionaire, at Concessionaire's sole cost and expense, shall promptly investigate and remediate, in accordance with requirements of all applicable Environmental Laws:

- A. Any release or threat of release of Hazardous Material on the Leased Premises or the Airport, including, but not limited to, into soil or groundwater, or City's sewage or storm drainage system which was caused or results in whole or in part from the activities of Concessionaire, Concessionaire's officers, agents, employees, contractors, permittees or invitees; except that Concessionaire shall have no responsibility for any release or threat of release of Hazardous Material which Concessionaire establishes was caused by the sole negligence or willful misconduct of City, City's officers, agents, employees, contractors or permittees by any third party, or by migration of Hazardous Materials onto the premises from a specifically identifiable source

off the use premises. In addition to all other rights and remedies of City hereunder, if Concessionaire does not promptly commence, and diligently pursue to remediate, to the extent required, any such release, or threat of release, of Hazardous Materials for which it has responsibility under this section, City, in its discretion, may pay to have same remediated and Concessionaire shall reimburse City plus a fifteen percent administration fee within fifteen (15) business days of City's demand for payment. The failure to commence investigation and provide City with a schedule for diligent completion of the remediation within thirty (30) days after discovery of such release, or threat of release, of Hazardous Material shall constitute prima facie evidence of failure to promptly commence remediation. The demand for payment by City shall be prima facie evidence that expense was incurred by City.

Subsection 50.5 Records and Inspections.

- A. Concessionaire will maintain a chemical inventory list and material safety data sheets of hazardous materials stored on site in accordance with state and federal regulations. The Concessionaire will also maintain manifests for all hazardous or regulated wastes transported and disposed of off-site.
- B. Upon reasonable notice by City, Concessionaire shall make available for review by City such records pertaining to the use, handling and disposal of any Hazardous Material(s) as Concessionaire is required to maintain under this section.
- C. City shall have the right, under the terms hereof, and upon reasonable notice for exclusive use space, to enter the Leased Premises during the Term hereof to conduct periodic environmental inspections and testing. City shall conduct each inspection or test in a manner that does not unreasonably interfere with Concessionaire's operations.

Subsection 50.6 Concessionaire Obligations upon Termination. Prior to vacating the Leased Premises, and in addition to all other requirements under this Agreement, Concessionaire shall remove any containers of Hazardous Materials placed on the Leased Premises during the Term by Concessionaire or as a result of Concessionaire's use or occupancy of the Leased Premises during the Term and shall demonstrate to City's reasonable satisfaction that such removal is in compliance with all applicable Environmental Laws, including without limitation conducting any environmental audits as may be required by City.

Subsection 50.7 Storm Water.

- A. Notwithstanding any other provisions or terms of this Agreement, Concessionaire acknowledges that certain properties within the Airport, or on City-owned land, are subject to storm water rules and regulations. Concessionaire agrees to observe and abide by such storm water rules and

regulations as may be applicable to City's property and Concessionaire's uses thereof.

- B. Concessionaire acknowledges that any storm water discharge permit issued to City may name Concessionaire as a co-permittee. City and Concessionaire both acknowledge that close cooperation is necessary to insure compliance with any storm water discharge permit terms and conditions, as well as to insure safety and to minimize cost of compliance. Concessionaire acknowledges further that it may be necessary to undertake such actions to minimize the exposure of storm water to "significant materials" generated, stored, handled or otherwise used by Concessionaire, as such term may be defined by applicable storm water rules and regulations, by implementing and maintaining "best management practices" as that term may be defined in applicable storm water rules and regulations.
- C. City will provide Concessionaire with written notice of any storm water discharge permit requirements applicable to Concessionaire and with which Concessionaire will be obligated to comply from time-to-time, including, but not limited to: certification of non-storm water discharges; collection of storm water samples; preparation of storm water pollution prevention or similar plans; implementation of best management practices; and maintenance of necessary records. Such written notice shall include applicable deadlines. Concessionaire agrees that within thirty (30) days of receipt of such written notice it shall notify City in writing if it disputes any of the storm water permit requirements it is being directed to undertake. If Concessionaire does not provide such timely notice, Concessionaire will be deemed to assent to undertake such storm water permit requirements. In that event, Concessionaire agrees to undertake, at its sole expense, unless otherwise agreed to in writing between City and Concessionaire, those storm water permit requirements for which it has received written notice from City, and Concessionaire agrees that it will hold harmless and indemnify City for any violations or non-compliance with any such permit requirements.

SECTION 51 – ISRAEL CLAUSE

Concessionaire hereby verifies that it does not boycott Israel and will not boycott Israel during the term of this Agreement. Boycotting Israel is defined in Texas Government Code section 808.001 to mean refusing to deal with, terminating business activities with, or taking any action that is intended to penalize, inflict economic harm on, or limit commercial relations specifically with Israel, or with a person or entity doing business in Israel or in an Israeli-controlled territory, but does not include an action made for ordinary business purposes.

IN WITNESS WHEREOF, the parties have executed this Agreement in duplicate on this ____ day of _____, 2018.

ATTEST:

CITY OF KILLEEN:

Lucy Aldrich
City Secretary

Ronald L. Olson
City Manager

ATTEST:

The Hertz Corporation

(name of signing authority)

(title)

EXHIBIT A1 - COUNTER/OFFICE/QUEUING AREAS

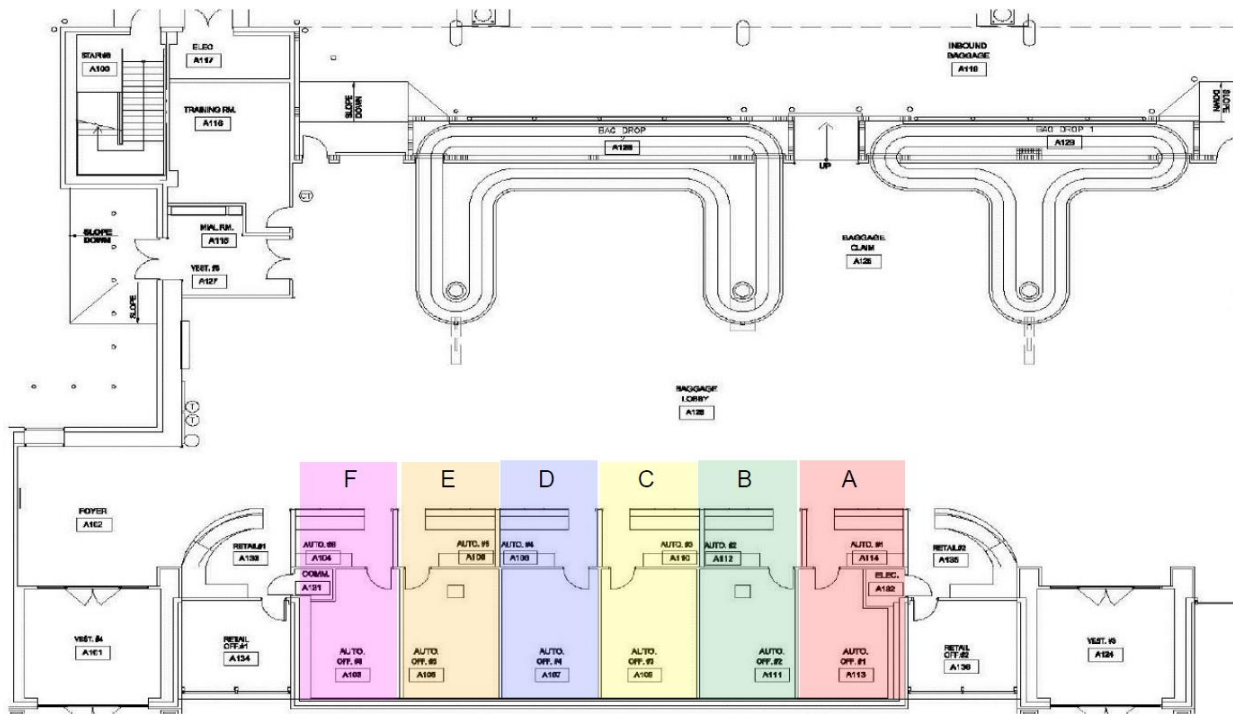

Space	Office	Counter Area	Queuing	Total Square Footage	Counter Length
A	199	107	102	408	12' 9"
B	232	109	103	444	12' 10"
C	232	109	103	444	12' 10"
D	232	109	103	444	12' 10"
E	232	109	103	444	12' 10"
F	199	104	102	405	12' 9"

REVISED EXHIBIT A2 - READY/RETURN BLOCKS AND SERVICE BAYS

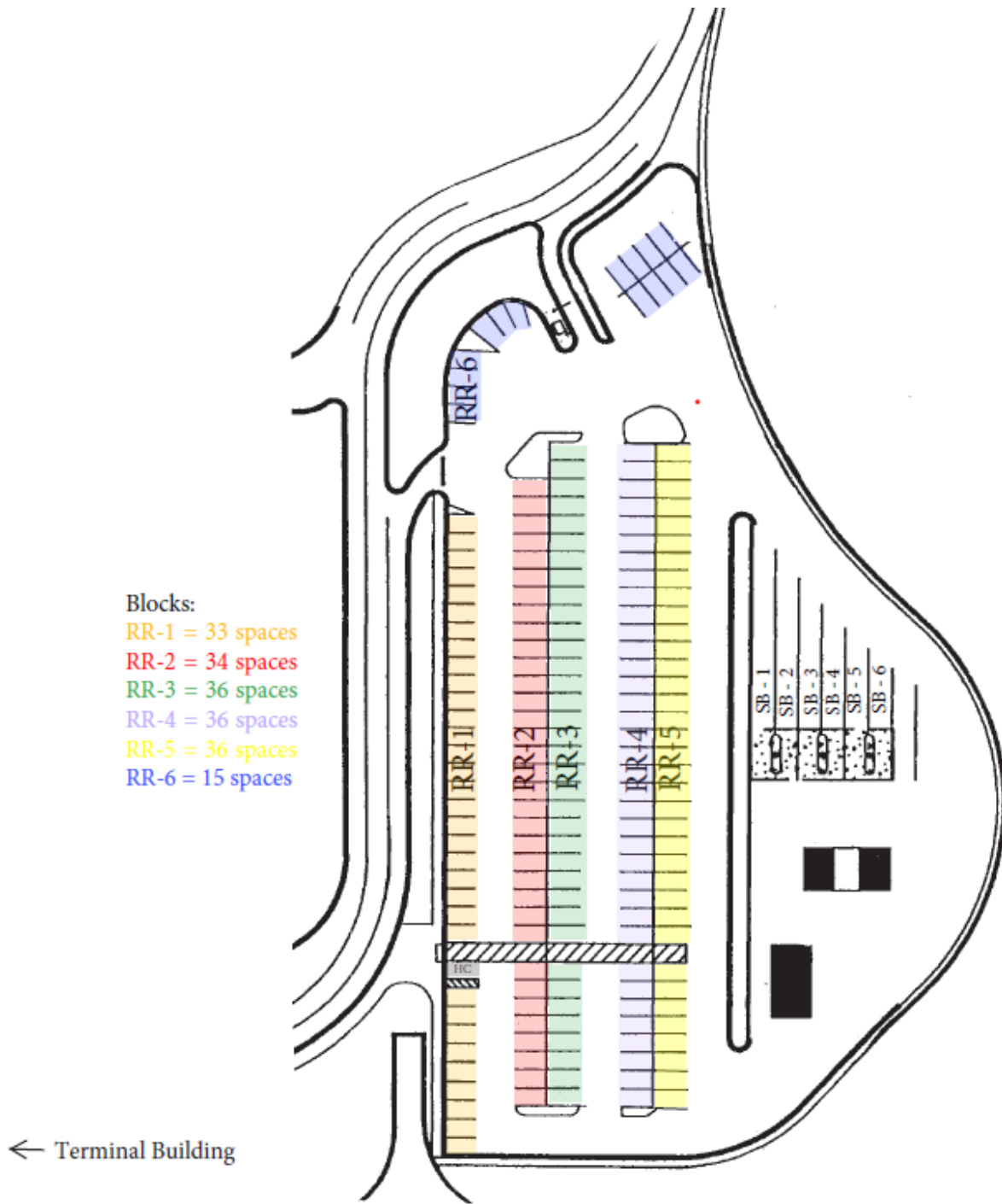

EXHIBIT A3 - STORAGE AREA

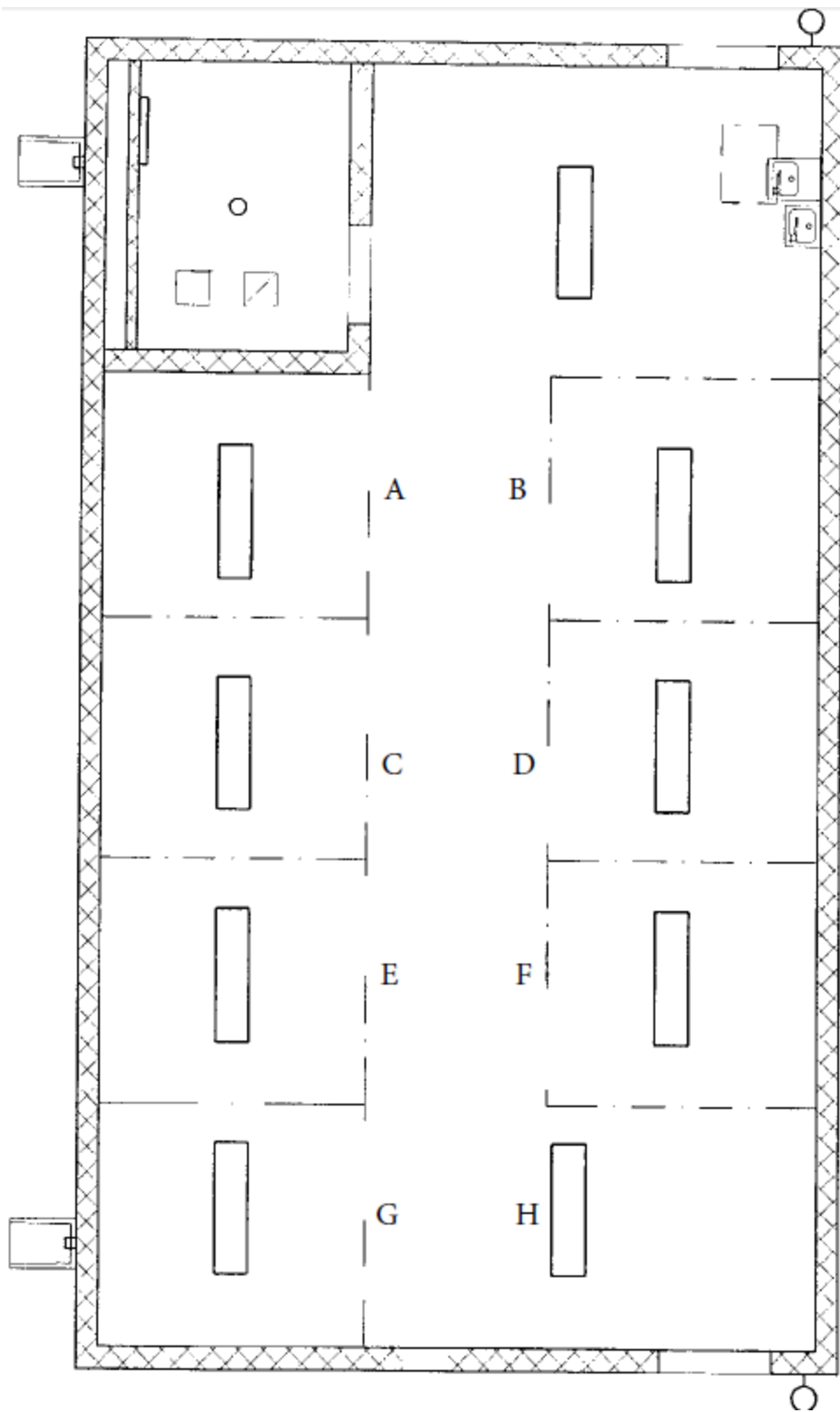

EXHIBIT A4 – OVERFLOW PARKING LANES

RENTAL CAR OVERFLOW
PARKING LOT

27 - LANES
Each lane 8'6" x 85'

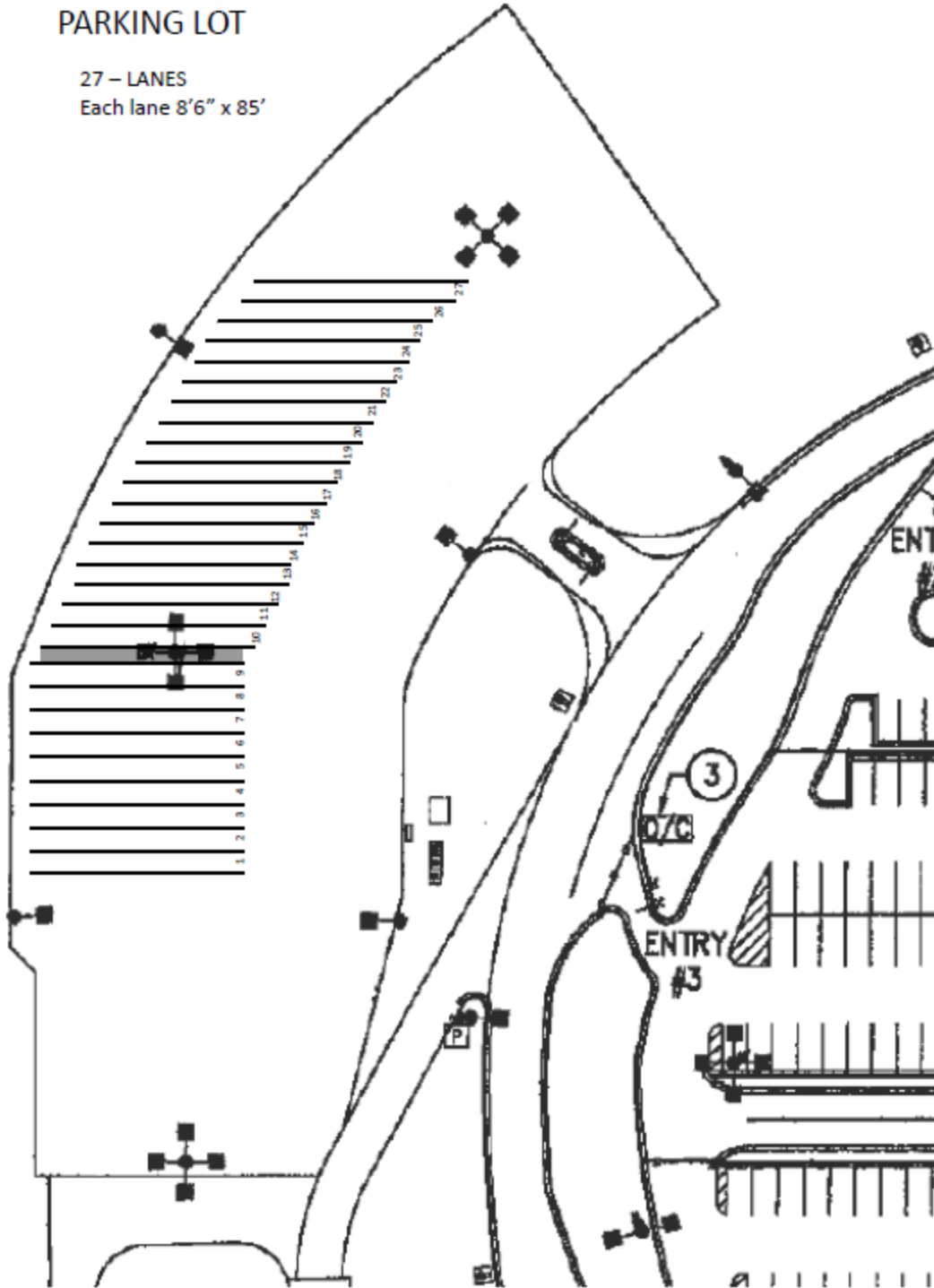

EXHIBIT B

KILLEEN – FORT HOOD REGIONAL AIRPORT
RENTAL CAR MONTHLY REPORT OF GROSS REVENUES
FOR MONTH OF _____

Concessionaire Name: _____

Address: _____

City, State, Zip: _____

Contact Name: _____

Phone # _____

GROSS RENTAL REVENUE: _____

Airport Fee (10%) _____

Less Monthly Guarantee paid 1st of month: _____

(1) Privilege Fee Balance Due: _____

Number of Transaction: _____

Number of Transaction Days: _____

(2) CFC Due (@ \$3.00 per Transaction Day): _____

Amount Due with this report (1) +(2): \$ _____

Concessionaire Official Signing and Certifying accuracy of Information on this report:

Signature _____

Typed Name & Title _____

Date signed _____

REMIT THIS FORM AND PAYMENT TO: City of Killeen Finance Department
Attn: Accounts Receivable
P.O. Box 1329
Killeen, TX 76540

CERTIFICATE OF INTERESTED PARTIES

FORM 1295

1 of 1

Complete Nos. 1 - 4 and 6 if there are interested parties.
Complete Nos. 1, 2, 3, 5, and 6 if there are no interested parties.

OFFICE USE ONLY CERTIFICATION OF FILING

1 Name of business entity filing form, and the city, state and country of the business entity's place of business.

Avis Budget Car Rental, LLC
Parsippany, NJ United States

Certificate Number:
2018-428133

Date Filed:
11/27/2018

2 Name of governmental entity or state agency that is a party to the contract for which the form is being filed.

The City of Killeen

Date Acknowledged:

3 Provide the identification number used by the governmental entity or state agency to track or identify the contract, and provide a description of the services, goods, or other property to be provided under the contract.

973-496-3441
Car Rental

4	Name of Interested Party	City, State, Country (place of business)	Nature of interest (check applicable)	
			Controlling	Intermediary
	NA, NA	NA, TX United States	X	X

5 Check only if there is NO Interested Party.

6 UNSWORN DECLARATION

My name is Anne D Morrison, and my date of birth is 9/22/61.

My address is 6 Sylvan Way (street), Parsippany (city), NJ (state), 07054 (zip code), USA (country).

I declare under penalty of perjury that the foregoing is true and correct.

Executed in Morris County, State of NJ, on the 12 day of Nov, 2018.
(month) (year)

Signature of authorized agent of contracting business entity
(Declarant)

CERTIFICATE OF INTERESTED PARTIES

FORM 1295

1 of 1

Complete Nos. 1 - 4 and 6 if there are interested parties.
Complete Nos. 1, 2, 3, 5, and 6 if there are no interested parties.

OFFICE USE ONLY CERTIFICATION OF FILING

Certificate Number:
2018-421009

Date Filed:
10/31/2018

Date Acknowledged:

1 Name of business entity filing form, and the city, state and country of the business entity's place of business.

The Hertz Corporation
Estero, FL United States

2 Name of governmental entity or state agency that is a party to the contract for which the form is being filed.

City of Killeen, Dept. of Aviation

3 Provide the identification number used by the governmental entity or state agency to track or identify the contract, and provide a description of the services, goods, or other property to be provided under the contract.

Bid 19-06
Rental Car Concession

4	Name of Interested Party	City, State, Country (place of business)	Nature of interest (check applicable)	
			Controlling	Intermediary

5 Check only if there is NO Interested Party.



6 UNSWORN DECLARATION

My name is Stephen Blum, and my date of birth is January 6, 1967.

My address is 8501 Williams Road, Estero, FL, 33928, USA.
(street) (city) (state) (zip code) (country)

I declare under penalty of perjury that the foregoing is true and correct.

Executed in Lee County, State of Florida, on the 13th day of November, 20 18.
(month) (year)

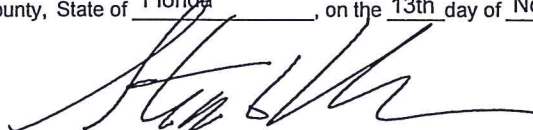

Signature of authorized agent of contracting business entity
(Declarant)

CERTIFICATE OF INTERESTED PARTIES

FORM 1295

1 of 1

Complete Nos. 1 - 4 and 6 if there are interested parties.
 Complete Nos. 1, 2, 3, 5, and 6 if there are no interested parties.

**OFFICE USE ONLY
 CERTIFICATION OF FILING**

Certificate Number:
 2018-423741

Date Filed:
 11/08/2018

Date Acknowledged:

1 Name of business entity filing form, and the city, state and country of the business entity's place of business.

EAN Holdings, LLC d/b/a Enterprise Rent-A-Car
 Austin, TX United States

2 Name of governmental entity or state agency that is a party to the contract for which the form is being filed.

City of Killeen, Texas

3 Provide the identification number used by the governmental entity or state agency to track or identify the contract, and provide a description of the services, goods, or other property to be provided under the contract.

Bid No. 19-06
 Non-Exclusive Rental Car Concession - Killeen-Fort Hood Regional Airport

4	Name of Interested Party	City, State, Country (place of business)	Nature of interest (check applicable)	
			Controlling	Intermediary
	Enterprise Holdings, Inc.	St. Louis, MO United States	X	
	Nicholson, Pamela M.	St. Louis, MO United States	X	
	Short, Rick A.	St. Louis, MO United States	X	
	Taylor, Andrew C.	St. Louis, MO United States	X	
*Please refer to Tab 4.A for a full list of Bidder's Officers and additional information.				

5 Check only if there is NO Interested Party.

6 UNSWORN DECLARATION

My name is Howard Zaroff, and my date of birth is 5-29-1964

My address is 4210 South Congress Avenue, Austin, TX, 78745, USA
(street) (city) (state) (zip code) (country)

I declare under penalty of perjury that the foregoing is true and correct.

Executed in Travis County, State of Texas, on the 8 day of November, 2018.
(month) (year)

 Signature of authorized agent of contracting business entity
(Declarant)

CERTIFICATE OF INTERESTED PARTIES

FORM 1295

1 of 1

Complete Nos. 1 - 4 and 6 if there are interested parties.
Complete Nos. 1, 2, 3, 5, and 6 if there are no interested parties.

OFFICE USE ONLY CERTIFICATION OF FILING

1 Name of business entity filing form, and the city, state and country of the business entity's place of business.

Clearwater Transportation, Ltd
Killeen, TX United States

Certificate Number:
2018-425090

Date Filed:
11/13/2018

2 Name of governmental entity or state agency that is a party to the contract for which the form is being filed.

City of Killeen

Date Acknowledged:

3 Provide the identification number used by the governmental entity or state agency to track or identify the contract, and provide a description of the services, goods, or other property to be provided under the contract.

Bid 19-06
Car Rental Service

4	Name of Interested Party	City, State, Country (place of business)	Nature of interest (check applicable)	
			Controlling	Intermediary

5 Check only if there is NO Interested Party.

6 UNSWORN DECLARATION

My name is W. Renee Mitchell, and my date of birth is 11/21/1960

My address is 12505 Crystal Creek, Buda, TX, 78610, US.
(street) (city) (state) (zip code) (country)

I declare under penalty of perjury that the foregoing is true and correct.

Executed in Bexar County, State of Texas, on the 12 day of November, 2018.
(month) (year)



Signature of authorized agent of contracting business entity
(Declarant)

CERTIFICATE OF INTERESTED PARTIES

FORM 1295

1 of 1

Complete Nos. 1 - 4 and 6 if there are interested parties.
 Complete Nos. 1, 2, 3, 5, and 6 if there are no interested parties.

OFFICE USE ONLY CERTIFICATION OF FILING

1 Name of business entity filing form, and the city, state and country of the business entity's place of business.

EAN Holdings, LLC d/b/a Alamo Rent A Car and National Car Rental
 Austin, TX United States

Certificate Number:
 2018-423732

Date Filed:
 11/08/2018

2 Name of governmental entity or state agency that is a party to the contract for which the form is being filed.

City of Killeen, Texas

Date Acknowledged:

3 Provide the identification number used by the governmental entity or state agency to track or identify the contract, and provide a description of the services, goods, or other property to be provided under the contract.

Bid No. 19-06
 Non-Exclusive Rental Car Concession - Killeen-Fort Hood Regional Airport

4	Name of Interested Party	City, State, Country (place of business)	Nature of interest (check applicable)	
			Controlling	Intermediary
	Enterprise Holdings, Inc.	St. Louis, MO United States	X	
	Nicholson, Pamela M.	St. Louis, MO United States	X	
	Short, Rick A.	St. Louis, MO United States	X	
	Taylor, Andrew C.	St. Louis, MO United States	X	
*Please refer to Tab 4.A for a full list of Bidder's Officers and additional information.				

5 Check only if there is NO Interested Party.

6 UNSWORN DECLARATION

My name is Howard Zaroff, and my date of birth is 5-29-1964.

My address is 4210 South Congress Avenue, Austin, TX, 78745, USA.
(street) (city) (state) (zip code) (country)

I declare under penalty of perjury that the foregoing is true and correct.

Executed in Travis County, State of Texas, on the 8 day of November, 2018.
(month) (year)

 Signature of authorized agent of contracting business entity
 (Declarant)



RENTAL CAR LEASE AGREEMENTS WITH KILLEEN FORT HOOD REGIONAL AIRPORT

RS-18-106

December 4, 2018

Rental Car Lease Agreements

2

- KFHRA has national brand rental car operators
 - ▣ Lease vehicles to customers and businesses
 - ▣ Operating at KFHRA since 2004

- Bid 19-06
 - ▣ Released in October 2018
 - ▣ Responses in November 2018
 - ▣ Five (5) responders
 - Avis Budget
 - Clearwater Transportation
 - EAN Holdings (Enterprise)
 - EAN Holdings (Alamo/National)
 - The Hertz Corporation

Rental Car Lease Agreements

3

- Agreement
 - ▣ Five (5) years
 - ▣ No extensions

- Annual revenue anticipated
 - ▣ \$800,000 in base rents and fees (annual CPI increase)
 - ▣ \$450,000 customer facility charges

Rental Car Lease Agreements

4

- Alternatives:
 - ▣ Approve the agreements
 - ▣ Do not approve the agreements

- Staff supports alternative 1
 - ▣ Provides continued excellent service to customers
 - ▣ Provides a consistent line of business revenue for KFHRA

Recommendation

5

- Approve the Rental Car Agreements with the aforementioned companies and authorize the City Manager or designee to execute same as well as any and all amendments as allowed per federal, state, or local law.



City of Killeen

Legislation Details

File #: RS-18-107 **Version:** 1 **Name:** 2019 State Legislative Priorities & Principles
Type: Resolution **Status:** Resolutions
File created: 11/19/2018 **In control:** City Council Workshop
On agenda: 12/4/2018 **Final action:**
Title: Consider a memorandum/resolution adopting the 2019 State Legislative Priorities and Principles.
Sponsors: City Council, Communications
Indexes:
Code sections:
Attachments: [Staff Report](#)
[State Legislative Priorities and Principles 2019](#)
[Presentation](#)

Date	Ver.	Action By	Action	Result
------	------	-----------	--------	--------



STAFF REPORT

DATE: December 4, 2018
TO: Ronald L. Olson, City Manager
FROM: Hilary Shine, Executive Director of Communications
SUBJECT: Adoption of 2019 State Legislative Priorities and Principles

BACKGROUND AND FINDINGS:

City of Killeen Governing Standards and Expectations sets forth direction that state legislative principles shall be adopted by City Council to guide representation of City interests at the state level.

A formal list of state legislative principles has been developed to enumerate general positions of support and opposition that can be applied to proposed legislation during the legislative process.

A formal list of state legislative priorities has been developed to enumerate actions we will pursue during the upcoming legislative session.

The adopted 2019 State Legislative Priorities and Principles document will be provided to state representatives of the City of Killeen and other legislators or agencies with an interest in issues that affect the City. It will also be provided to our state lobbyist to guide their work on our behalf.

THE ALTERNATIVES CONSIDERED:

Alternatives considered: (1) adopt 2019 State Legislative Priorities and Principles; (2) do not adopt 2019 State Legislative Priorities and Principles.

Which alternative is recommended? Why?

Staff recommends alternative 1. Adoption of 2019 State Legislative Priorities and Principles complies with City of Killeen Governing Standards and Expectations Section 2-10 and provides the framework for representing the City's interests at the state government level.

CONFORMITY TO CITY POLICY:

Yes

FINANCIAL IMPACT:

No

What is the amount of the expenditure in the current fiscal year? For future years?

None

Is this a one-time or recurring expenditure?

N/A

Is this expenditure budgeted?

N/A

If not, where will the money come from?

N/A

Is there a sufficient amount in the budgeted line-item for this expenditure?

N/A

RECOMMENDATION:

Staff recommends that City Council approve adoption of the 2019 State Legislative Priorities and Principles.

DEPARTMENTAL CLEARANCES:

Legal

ATTACHED SUPPORTING DOCUMENTS:

State Legislative Priorities and Principles 2019



CITY OF KILLEEN

State Legislative Priorities and Principles

2019

Action Priorities

- The City of Killeen will seek full reimbursement from the State of Texas for lost revenue due to state-granted veterans exemptions.
- The City of Killeen will oppose any extension of state veterans exemptions that is not fully funded by the State of Texas.

Guiding Principles

- The City of Killeen supports legislation that would provide benefit to military communities.
- The City of Killeen supports legislation that would provide local relief for disproportionate impacts of state exemptions and programs.
- The City of Killeen supports legislation that would provide transportation funding for local projects.
- The City of Killeen supports legislation that would provide funding for local park, trail or public grounds projects.
- The City of Killeen supports legislation that would be beneficial to Texas A&M University-Central Texas, Central Texas College and/or Killeen Independent School District.
- The City of Killeen opposes legislation that would remove or limit local control or preempt local authority.
- The City of Killeen opposes legislation that would be detrimental to current or potential City revenue.
- The City of Killeen opposes legislation that would impose unfunded mandates.
- The City of Killeen opposes legislation that would erode zoning authority.
- The City of Killeen opposes legislation that would be detrimental to local economic development efforts.
- The City of Killeen opposes legislation that would create an adverse impact by imposing environmental or water restrictions or regulations.



ADOPTION OF 2019 STATE LEGISLATIVE PRIORITIES AND PRINCIPLES

RS-18-107

December 4, 2018

Legislative Principles Background

- Council's Governing Standards and Expectations Section 2-10 sets forth direction that City Council will adopt state legislative principles.
- Legislative principles serve as a guide for representing the City's interests at the state level.
- Staff developed a draft for Council's consideration.
- Upon approval, the document will be provided to state representatives of Killeen and other state officials and agencies with an interest in issues that affect our community. It will also be provided to our lobbyist.

Proposed State Action Priorities

3

□ Action Priorities

- The City of Killeen will seek full reimbursement from the State of Texas for lost revenue due to state-granted veterans exemptions.
- The City of Killeen will oppose any extension of state veterans exemptions that is not fully funded by the State of Texas.

Proposed State Guiding Principles

4

□ Guiding Principles

▣ Support legislation that:

- Benefits military communities
- Provides relief for disproportionate impact
- Provides transportation/park funding
- Benefits KISD, CTC or TAMU-CT

▣ Oppose legislation that:

- Limits local control or authority
- Would be detrimental to current or future revenue
- Imposes unfunded mandates
- Erodes zoning authority
- Would be detrimental to economic development

Alternatives Considered

- Alternatives Considered
 - ▣ 1. Adopt 2019 State Legislative Priorities and Principles as drafted
 - ▣ 2. Adopt an alternate version
 - ▣ 3. Do not adopt 2019 State Legislative Priorities and Principles

- Staff recommends alternative No. 1
 - ▣ Adoption complies with Governing Standards and Expectations and provides the framework for representing the City's interests at the state level.

Recommendation

6

- Staff recommends that City Council adopt 2019 State Legislative Priorities and Principles.



City of Killeen

Legislation Details

File #: RS-18-108 **Version:** 1 **Name:** Water and Sewer Supply Items
Type: Resolution **Status:** Resolutions
File created: 11/19/2018 **In control:** City Council Workshop
On agenda: 12/4/2018 **Final action:**
Title: Consider a memorandum/resolution awarding Bid No. 19-04 for a Water and Sewer supply items purchase agreement with ACT Pipe and Supply, Ferguson Waterworks, and Zenner USA.
Sponsors: Water & Sewer
Indexes: Water Division Supply Items
Code sections:
Attachments: [Staff Report](#)
[Bid Tab Sheet](#)
[Certificate of Interested Parties](#)
[Presentation](#)

Date	Ver.	Action By	Action	Result
------	------	-----------	--------	--------



STAFF REPORT

DATE: December 4, 2018
TO: Ronald L. Olson, City Manager
FROM: David A. Olson, Executive Director of Public Works
SUBJECT: Authorize the Award of BID 19-04 - Water and Sewer Supply Items

BACKGROUND AND FINDINGS:

Notice was advertised Sunday October 28, 2018, and Sunday November 4, 2018, in the Killeen Daily Herald that the City of Killeen will receive sealed bids for the annual contract for water and sewer supply items. These items are used by the Water & Sewer Division of Public Works throughout the year to operate and maintain the water distribution system and sanitary sewer collection system. On Wednesday, November 14, 2018 at 3:15 p.m. bids were opened and read aloud on the 2nd floor RM# 215 at Building E 802 N. 2nd Street Killeen, Texas 76541.

Bidders	Total Price
ACT Pipe and Supply	455,093.50
Ferguson Waterworks	623,046.00
Zenner Performance Meters, Inc.	132,974.25 partial bid
Thirkettle Corp dba Aqua Metrics Sales Co	139,139.00 partial bid

Bid 19-04 tabulation contains an itemized list of all supply items with the corresponding bid submissions received per vendor. Johnson Supply Company whom previously bid on 19-04 Water and Sewer Supply Items retracted their bid as of November 19, 2018.

THE ALTERNATIVES CONSIDERED:

1. Purchasing agent can request for individual orders per item, cost and quantity under \$3,000.00.
2. Purchasing agent is required to request for multiple quotes per orders totaling over \$3,000.00 - \$49,999. Requiring a 3 Quote process and Purchase Order to be generated per requirements by the State of Texas.
3. Award a purchase agreement for the FY 2019-2020 under BID 19-04 Water and Sewer Supply Item in the estimated amount \$250,000.00 to approve vendors per individual item, quantity, unit cost and extended price.

Which alternative is recommended? Why?

Alternative 3 is recommended because:

1. This alleviates the need for individual orders or multiple quotes for each purchase request under/over \$3,000.00 on items required to maintain City of Killeen Water Distribution Lines and Customer Services.
2. Locks in price per unit cost and extended prices, saving the City of Killeen from possible increased item costs throughout FY 2019-2020 based on market fluctuation.

CONFORMITY TO CITY POLICY:

Authorizing Purchase Agreements between The City of Killeen and ACT Pipe and Supply, Ferguson Waterworks, Zenner USA per BID 19-04 Water and Sewer Supply Items, conforms to all State and City purchasing policies.

FINANCIAL IMPACT:

What is the amount of the expenditure in the current fiscal year? For future years?

The expenditure amount for the warehouse supply items is approximately \$250,000.00 and will be charged to 550-0000-120.09-00, 550-3410-436.60-65, 550-3410-436.60-75, 550-3410-436.60-70. This amount of expenditure is available in fiscal year 2019 and 2020.

Is this expenditure budgeted? If not, where will the money come from?

This expenditure is budgeted.

Is there a sufficient amount in the budgeted line-item for this expenditure?

Yes, there is a sufficient amount in the budgeted line-item for this expenditure.

RECOMMENDATION:

Staff recommends that the following vendors are awarded the corresponding bids and that the City Manager is expressly authorized to execute any and all changes within the amounts set by state and local law.

Section 1

Items 1-2: Ferguson Waterworks is the lowest bidder on these items. They met all bid requirements. Staff recommends that these items be awarded to Ferguson Waterworks.

Items 3-10: ACT Pipe and Supply is the lowest bidder on these items. They met all bid requirements. Staff recommends that these items be awarded to ACT Pipe and Supply.

Section 2

Items 1-3: Zenner Performance Meters, Inc. is the lowest bidder on these items. They met all bid requirements. Staff recommends that these items be awarded to Zenner Performance Meters, Inc.

Item 4: Ferguson Waterworks is the lowest bidder on these items. They met all bid requirements. Staff recommends that these items be awarded to Ferguson Waterworks.

Item 5: ACT Pipe and Supply is the lowest bidder on these items. They met all bid requirements. Staff recommends that these items be awarded to ACT Pipe and Supply.

Section 3

Items 1-19: ACT Pipe and Supply is the lowest bidder on these items. They met all bid requirements. Staff recommends that these items be awarded to ACT Pipe and Supply.

DEPARTMENTAL CLEARANCES:

Public Works

Finance

City Attorney

ATTACHED SUPPORTING DOCUMENTS:

Bid Tab Sheet

Certificate of Interested Parties

1-FIRE HYDRANTS & TUBING

Description	Qty	U.O.M	VENDOR ACT PIPE & SUPPLY		VENDOR AQUA METRIC		VENDOR FERGUSON		VENDOR JOHNSON LAB & SUPPLY		
			Unit Price	Extended Price	Unit Price	Extended Price	Unit Price	Extended Price	Unit Price	Extended Price	
1. ¾" Endopure Poly Tubing/300' Rolls	10,200	Ft.	.24	2,448 ⁰⁰	No Bid		.21	2,142 ⁰⁰	No Bid		
2. 1" Endopure Poly Tubing/300' Rolls	30,000	Ft.	.41	12,300 ⁰⁰	No Bid		.34	10,200 ⁰⁰			
3. 3' Fire Hydrant	5	Ea	1,420	7,100 ⁰⁰	No Bid		1,554 ³⁰	7,771 ⁵⁰			
4. 3 ½' Fire Hydrant	5	Ea	1,447 ⁵⁰	7,237 ⁵⁰	No Bid		1,592 ⁴⁰	7,962 ⁰⁰			
5. 4' Fire Hydrant	5	Ea	1,475 ⁰⁰	7,375 ⁰⁰	No Bid		1,630 ⁰²	8,150 ¹⁰			
6. 4 ½' Fire Hydrant	5	Ea	1,507 ⁵⁰	7,537 ⁵⁰	No Bid		1,668 ¹⁵	8,340 ⁷⁵			
7. 5' Fire Hydrant	5	Ea	1,540	7,700 ⁰⁰	No Bid		1,705 ⁷⁴	8,528 ⁷⁰			
8. 5 ½' Fire Hydrant	5	Ea	1,560 ⁰⁰	7,800 ⁰⁰	No Bid		1,743 ⁸⁵	8,719 ²⁵			
9. 6' Fire Hydrant	2	Ea	1,590 ⁰⁰	3,180 ⁰⁰	No Bid		1,781 ⁴⁵	3,562 ⁹⁰			
10. 7' Fire Hydrant	2	Ea	1,650 ⁰⁰	3,300 ⁰⁰	No Bid		1,857 ¹⁵	3,714 ³⁰		No Bid	

2-METERS & METER BOXES

Description	Qty		VENDOR ACT PIPE & SUPPLY		VENDOR AQUA METRIC		VENDOR FERGUSON		VENDOR JOHNSON LAB & SUPPLY	
			Unit Price	Extended Price	Unit Price	Extended Price	Unit Price	Extended Price	Unit Price	Extended Price
1. 5/8 x 3/4" positive displacement residential meters (threaded)	2500		N/A		39.23 ^{12"}	98,075 ^{12"} 150,025	44.25	110,625 ⁰⁰		No Bid
2. 1" positive displacement meters (threaded)	100		N/A		84.13 150.74	8,413 15,074	152 ⁰⁰	15,200 ⁰⁰		
3. 1 1/2" Compound meters with flange ends	25		N/A		874 ⁰⁴	17,430 ⁸⁰	391 ¹¹	9,777 ⁷⁵		
4. 2" Compound meters with flange ends	25		N/A		1,008 ⁵¹	20,190 ²⁰	575 ¹²	14,378 ⁰⁰		
5. Small Plastic Water Meter Box D1300 STD plastic, rectangular, black box with black plastic lid and plastic reader 12" x 17" x 12" or 12" H x 12 5/16" W x 17 9/16" L	2000		15.45	30,900 ⁰⁰		No Bid	15.65	31,300 ⁰⁰		No Bid

3-BRASS SADDLES AND FITTINGS

Description	Qty	U.O.M	VENDOR ACT PIPE & SUPPLY		VENDOR AQUA METRIC		VENDOR FERGUSON		VENDOR JOHNSON LAB & SUPPLY	
			Unit Price	Extended Price	Unit Price	Extended Price	Unit Price	Extended Price	Unit Price	Extended Price
1. 6" x 3/4" C-900 Hinged Tapping Saddle with cc Thread	300	Ea	36.05	10,815 ⁰⁰		No Bid	36.90	11,070 ⁰⁰	38.50	11,550
2. 6" x 1" C-900 Hinged Tapping Saddle with cc Thread	1500	Ea	36.05	54,075			36.95	55,425 ⁰⁰	38 ⁵⁰	57,750

3. 8" x 3/4" C-900 Hinged Tapping Saddle with cc Thread	200	Ea	50.56	10,112 ⁰⁰	No Bid	51 ⁶⁵	10,330 ⁰⁰	53 ⁸⁹	10,778
4. 8" x 1" C-900 Hinged Tapping Saddle with cc Thread	500	Ea	50.56	25,280 ⁰⁰		51.70	25,350 ⁰⁰	53 ²⁹	26,945
5. 3/4" Ball Angle Stop Reduced Port Q-nut compression by Meter Nut w/Lock Wing	2000	Ea	31.75	63,500 ⁰⁰		32 ³⁵	64,700	34 ¹⁰	68,200
6. 3/4" x 5/8" x 2 1/2" Meter Coupling	2500	Ea	6.99	17,475 ⁰⁰		7 ¹⁰	17,750	7 ⁴⁸	18,700
7. 3/4" x 3/4" x 1" Tee (Q-nut compression)	1000	Ea	33.90	33,900 ⁰⁰		34 ²⁵	34,250 ⁰⁰	36 ¹⁴	36,140
8. 3/4" Corp. stop (ball valve) Q-nut by cc Thread Male	500	Ea	34 ⁸⁴	17,420 ⁰⁰		35 ⁰⁰	17,600 ⁰⁰	25 ¹¹	12,555
9. 1" Corp. Stop (ball valve) Q-nut by cc Thread Male	1500	Ea	45 ³⁶	68,790		46 ³⁵	69,525 ⁰⁰	37 ⁹⁷	56,955
10. 2" Corp. Stop (ball valve) Q-nut by cc Thread Male	75	Ea	169 ⁵⁰	12,712 ⁰⁰		173 ⁵⁰	13,012 ⁵⁰	181 ⁰⁵	13,573 ⁷⁵
11. 2" Angle Stop (ball valve) Q-nut by 2" Meter Flange w/Lock Wing	75	Ea	139 ⁵⁰	10,462 ⁰⁰		245 ³⁵	18,401 ²⁵	256 ⁰³	19,200 ²⁵
12. 1" Angle Stop Ball Valve Q-nut Compression by 1" Meter Nut w/Lock Wing	50	Ea	82 ⁰⁵	4,102 ⁰⁰		83 ⁸⁰	4,190 ⁰⁰	87 ⁴²	4,391 ⁰⁰ 4,371
13. 1 1/2" Corp. Stop (ball valve) Q-nut by cc Thread Male	25	Ea	102 ⁷⁷	2,569 ²⁵		104 ⁹⁰	2,622 ⁵⁰	109 ⁴⁷	2,736 ⁷⁵
14. 1 1/2" Angle Stop (ball valve) Q-nut by 1 1/2" Meter Flange w/Lock Wing	25	Ea	189 ²¹	4,730 ²⁵		193 ³⁰	4,832 ⁵⁰	201 ⁷⁰	5,042 ⁵⁰
15. 3/4" Stainless Steel Inserts	3,000	Ea	1.12	3,360 ⁰⁰		1.17	3,510	1 ¹⁸	3,540
16. 1" Stainless Steel Inserts	5,000	Ea	1.17	5,850 ⁰⁰		1.25	6,250 ⁰⁰	1 ²⁶	6,300
17. 3/4" 3 Part Union Q-nut Compression Ends	200	Ea	14.04	2,808 ⁰⁰		14 ³⁵	2,870 ⁰⁰	14 ⁹⁸	2,996 ⁰⁰
18. 1" 3 Part Union Q-nut Compression Ends	150	Ea	16.05	2,407 ⁵⁰	No Bid	16 ⁴⁰	2,460 ⁰⁰	17 ¹²	2,568
19. 3/4" Ball Angle Stop Reduced Port Flare by Meter Nut w/Lock Wing	250	Ea	31 ³⁹	7,847 ⁵⁰		32 ¹⁰	8,025	33 ⁴⁷	8,367 ⁵⁰

1-FIRE HYDRANTS & TUBIING

			<u>VENDOR</u>		<u>VENDOR</u>		<u>VENDOR</u>		<u>VENDOR</u>	
			ZENNER USA							
<u>Description</u>	<u>Qty</u>	<u>U.O.M</u>	<u>Unit Price</u>	<u>Extended Price</u>	<u>Unit Price</u>	<u>Extended Price</u>	<u>Unit Price</u>	<u>Extended Price</u>	<u>Unit Price</u>	<u>Extended Price</u>
1. ¾" Endopure Poly Tubing/300' Rolls	10,200	Ft.	No Bid							
2. 1" Endopure Poly Tubing/300' Rolls	30,000	Ft.								
3. 3' Fire Hydrant	5	Ea								
4. 3 ½' Fire Hydrant	5	Ea								
5. 4' Fire Hydrant	5	Ea								
6. 4 ½' Fire Hydrant	5	Ea								
7. 5' Fire Hydrant	5	Ea								
8. 5 ½' Fire Hydrant	5	Ea								
9. 6' Fire Hydrant	2	Ea								
10. 7' Fire Hydrant	2	Ea	No Bid							

2-METERS & METER BOXES

			<u>VENDOR</u>		<u>VENDOR</u>		<u>VENDOR</u>		<u>VENDOR</u>	
			ZENNER USA							
<u>Description</u>	<u>Qty</u>		<u>Unit Price</u>	<u>Extended Price</u>	<u>Unit Price</u>	<u>Extended Price</u>	<u>Unit Price</u>	<u>Extended Price</u>	<u>Unit Price</u>	<u>Extended Price</u>
1. 5/8 x 3/4" positive displacement residential meters (threaded)	2500		33 ⁸⁰	84,500						
2. 1" positive displacement meters (threaded)	100		80 ¹³	8,013 ⁰⁰						
3. 1 1/2" Compound meters with flange ends	25		223 ²⁴	5,581 ⁰⁰						
4. 2" Compound meters with flange ends	25		1,395 ²¹	34,880 ²⁵						
5. Small Plastic Water Meter Box D1300 STD plastic, rectangular, black box with black plastic lid and plastic reader 12" x 17" x 12" or 12" H x 12 5/16" W x 17 9/16" L	2000		No Bid							

3-BRASS SADDLES AND FITTINGS

			<u>VENDOR</u>		<u>VENDOR</u>		<u>VENDOR</u>		<u>VENDOR</u>	
			ZENNER USA							
<u>Description</u>	<u>Qty</u>	<u>U.O.M</u>	<u>Unit Price</u>	<u>Extended Price</u>	<u>Unit Price</u>	<u>Extended Price</u>	<u>Unit Price</u>	<u>Extended Price</u>	<u>Unit Price</u>	<u>Extended Price</u>
1. 6" x 3/4" C-900 Hinged Tapping Saddle with cc Thread	300	Ea	No Bid							
2. 6" x 1" C-900 Hinged Tapping Saddle with cc Thread	1500	Ea	No Bid							
3. 8" x 3/4" C-900 Hinged Tapping Saddle with cc Thread	200	Ea	No Bid							

4. 8" x 1" C-900 Hinged Tapping Saddle with cc Thread	500	Ea	<i>No Bid</i>								
5. 3/4" Ball Angle Stop Reduced Port Q-nut compression by Meter Nut w/Lock Wing	2000	Ea									
6. 3/4" x 5/8" x 2 1/2" Meter Coupling	2500	Ea									
7. 3/4" x 3/4" x 1" Tee (Q-nut compression)	1000	Ea									
8. 3/4" Corp. stop (ball valve) Q-nut by cc Thread Male	500	Ea									
9. 1" Corp. Stop (ball valve) Q-nut by cc Thread Male	1500	Ea									
10. 2" Corp. Stop (ball valve) Q-nut by cc Thread Male	75	Ea									
11. 2" Angle Stop (ball valve) Q-nut by 2" Meter Flange w/Lock Wing	75	Ea									
12. 1" Angle Stop Ball Valve Q-nut Compression by 1" Meter Nut w/Lock Wing	50	Ea									
13. 1 1/2" Corp. Stop (ball valve) Q-nut by cc Thread Male	25	Ea									
14. 1 1/2" Angle Stop (ball valve) Q-nut by 1 1/2" Meter Flange w/Lock Wing	25	Ea									
15. 3/4" Stainless Steel Inserts	3,000	Ea									
16. 1" Stainless Steel Inserts	5,000	Ea									
17. 3/4" 3 Part Union Q-nut Compression Ends	200	Ea									
18. 1" 3 Part Union Q-nut Compression Ends	150	Ea									
19. 3/4" Ball Angle Stop Reduced Port Flare by Meter Nut w/Lock Wing	250	Ea		<i>No Bid</i>							

CERTIFICATE OF INTERESTED PARTIES

FORM 1295

1 of 1

Complete Nos. 1 - 4 and 6 if there are interested parties.
 Complete Nos. 1, 2, 3, 5, and 6 if there are no interested parties.

**OFFICE USE ONLY
 CERTIFICATION OF FILING**

Certificate Number:
 2018-426976

Date Filed:
 11/19/2018

Date Acknowledged:

1 Name of business entity filing form, and the city, state and country of the business entity's place of business.
 Aqua-Metric Sales Company
 Selma, TX United States

2 Name of governmental entity or state agency that is a party to the contract for which the form is being filed.
 City of Killeen Water & Sewer

3 Provide the identification number used by the governmental entity or state agency to track or identify the contract, and provide a description of the services, goods, or other property to be provided under the contract.
 Bid Number 19-04
 Water and Sewer and Supply Items

4	Name of Interested Party	City, State, Country (place of business)	Nature of interest (check applicable)	
			Controlling	Intermediary
	Kohan, Scott	Selma, TX United States		X
	Segarra, Kristy	Selma, TX United States		X
	Cartwright, Michael	Selma, TX United States		X
	Aqua-Metric Sales Company	Selma, TX United States		X

5 Check only if there is NO Interested Party.

6 UNSWORN DECLARATION

My name is Mike Cartwright, and my date of birth is 05/14/1955.

My address is 16914 Alamo Parkway, Selma, TX, 78154, USA.
(street) (city) (state) (zip code) (country)

I declare under penalty of perjury that the foregoing is true and correct.

Executed in Guadalupe County, State of Texas, on the 19 day of November, 2018.
(month) (year)

Signature of authorized agent of contracting business entity
 (Declarant)

CERTIFICATE OF INTERESTED PARTIES

FORM 1295

1 of 1

Complete Nos. 1 - 4 and 6 if there are interested parties.
Complete Nos. 1, 2, 3, 5, and 6 if there are no interested parties.

OFFICE USE ONLY CERTIFICATION OF FILING

Certificate Number:
2018-426926

Date Filed:
11/19/2018

Date Acknowledged:

1 Name of business entity filing form, and the city, state and country of the business entity's place of business.

Zenner Performance Meters, Inc.
Addison, TX United States

2 Name of governmental entity or state agency that is a party to the contract for which the form is being filed.

City of Killeen

3 Provide the identification number used by the governmental entity or state agency to track or identify the contract, and provide a description of the services, goods, or other property to be provided under the contract.

Bid No. 19-04
Water & Sewer Supply Items

4	Name of Interested Party	City, State, Country (place of business)	Nature of interest (check applicable)	
			Controlling	Intermediary
	Sanders, Richard	Addison, TX United States		X

5 Check only if there is NO Interested Party.

6 UNSWORN DECLARATION

My name is Richard Sanders, and my date of birth is December 21, 1949.

My address is 1903 Pearson Crossing, Keller, TX, 76248, USA.
(street) (city) (state) (zip code) (country)

I declare under penalty of perjury that the foregoing is true and correct.

Executed in Dallas County, State of Texas, on the 19th day of November, 2018.
(month) (year)

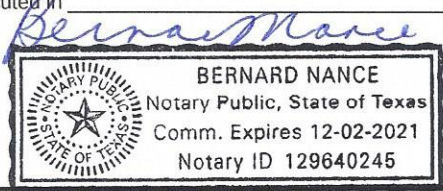

Richard Sanders
Signature of authorized agent of contracting business entity (Declarant)

CERTIFICATE OF INTERESTED PARTIES

FORM 1295

1 of 1

Complete Nos. 1 - 4 and 6 if there are interested parties.
 Complete Nos. 1, 2, 3, 5, and 6 if there are no interested parties.

OFFICE USE ONLY CERTIFICATION OF FILING

1 Name of business entity filing form, and the city, state and country of the business entity's place of business.

FERGUSON
 TYLER, TX United States

Certificate Number:
 2018-426904

Date Filed:
 11/19/2018

Date Acknowledged:

2 Name of governmental entity or state agency that is a party to the contract for which the form is being filed.

CITY OF KILLEEN

3 Provide the identification number used by the governmental entity or state agency to track or identify the contract, and provide a description of the services, goods, or other property to be provided under the contract.

19-04
 WATER & SEWER SUPPLY

4	Name of Interested Party	City, State, Country (place of business)	Nature of interest (check applicable)	
			Controlling	Intermediary

5 Check only if there is NO Interested Party.

6 UNSWORN DECLARATION

My name is FERGUSON, and my date of birth is 05/25/1986.

My address is 7982 US HWY 69 N, TYLER, TX, 75706.
(street) (city) (state) (zip code) (country)

I declare under penalty of perjury that the foregoing is true and correct.

Executed in SMITH County, State of TX, on the 19 day of NOVEMBER ~~2018~~, 2018.
(month) (year)

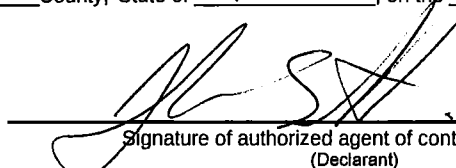
 Signature of authorized agent of contracting business entity
 (Declarant)

CERTIFICATE OF INTERESTED PARTIES

FORM 1295

1 of 1

Complete Nos. 1 - 4 and 6 if there are interested parties.
 Complete Nos. 1, 2, 3, 5, and 6 if there are no interested parties.

OFFICE USE ONLY CERTIFICATION OF FILING

1 Name of business entity filing form, and the city, state and country of the business entity's place of business.

ACT Pipe and Supply
 Temple, TX United States

Certificate Number:
 2018-427174

Date Filed:
 11/20/2018

2 Name of governmental entity or state agency that is a party to the contract for which the form is being filed.

CITY OF KILLEEN

Date Acknowledged:

3 Provide the identification number used by the governmental entity or state agency to track or identify the contract, and provide a description of the services, goods, or other property to be provided under the contract.

19-04
 WATER SUPPLIES

4	Name of Interested Party	City, State, Country (place of business)	Nature of interest (check applicable)	
			Controlling	Intermediary

5 Check only if there is NO Interested Party.

6 UNSWORN DECLARATION

My name is _____, and my date of birth is _____.

My address is _____, _____, _____, _____, _____.
(street) (city) (state) (zip code) (country)

I declare under penalty of perjury that the foregoing is true and correct.

Executed in _____ County, State of _____, on the ____ day of _____, 20____.
(month) (year)

 Signature of authorized agent of contracting business entity
 (Declarant)



BID 19-04 WATER & SEWER SUPPLY ITEMS

RS-18-108

December 4, 2018

Background

- Notice for bid was advertised for the annual contract Bid 19-04 for Water and Sewer Supply items.
- On Wednesday, November 14, 2018 at 3:15 p.m. bids were opened and read aloud.
- These items are used by the Water & Sewer Division of Public Works throughout the year to operate and maintain the water distribution system and sewer collection system.
- The estimated expenditure for the warehouse supply items is approximately \$265,000 and this expenditure is available in fiscal year 2019 and 2020.
- Johnson Supply Company has retracted their bid as of November 19, 2018.

Alternatives

3

- Request individual purchase orders for each item.
- Purchase using a 3 quote system multiple times per year for various items.
- Award a purchase agreement for up to \$265,000 to approve vendors and lock in prices.

Recommendation

- Staff recommends that the following vendors are awarded the corresponding bids and that the City Manager is expressly authorized to execute any and all changes within the amounts set by state and local law.
 - ACT Pipe and Supply – Section 1, Items 3-10; Section 2, Item 5; & Section 3, Items 1-19
 - Ferguson Waterworks – Section 1, Items 1-2; & Section 2, Item 4
 - Zenner Performance Meters – Section 2, Items 1-3



City of Killeen

Legislation Details

File #: OR-18-017 **Version:** 1 **Name:** Street Maintenance Fee Ordinance
Type: Ordinance **Status:** Ordinances
File created: 11/27/2018 **In control:** City Council Workshop
On agenda: 12/4/2018 **Final action:**
Title: Consider an ordinance amending Chapter 25, Streets, Sidewalks, and Miscellaneous Public Places by establishing a Street Maintenance Fund and providing for collection of street maintenance fees.
Sponsors: Public Works Department
Indexes:
Code sections:
Attachments: [Staff Report](#)
[Ordinance](#)
[Presentation](#)

Date	Ver.	Action By	Action	Result
------	------	-----------	--------	--------



STAFF REPORT

DATE: December 4, 2018

TO: Ronald L. Olson, City Manager

FROM: David A. Olson, Executive Director of Public Works

SUBJECT: Ordinance establishing a Street Maintenance Fund and providing for the collection of street maintenance fees

BACKGROUND AND FINDINGS:

On October 23, 2018 the City Council re-engaged in a discussion surrounding the funding of street maintenance. City staff through the basis of both third party and in house studies developed the following departmental needs:

Category	FY 2019 Budget	Cost per Lane Mile	Recommended Adjustment	Cost per Lane Mile
Personnel Services	\$2,500,566	\$1,141	\$0	\$1,141
Materials & Supplies	629,727	287	0	287
Street Light Electricity	750,000	342	0	342
Pavement Treatments	330,000	151	1,639,402	899
Pavement Markings	92,311	42	0	42
Signals & Traffic Control	86,650	40	0	40
Total	\$4,389,254	\$2,003	\$1,639,402	\$2,751

After thorough discussion and consideration by City Council, staff was directed to provide an ordinance establishing a street maintenance fee to increase revenues as necessary to provide the recommended adjustment to the pavement treatment budget. This ordinance also establishes a special revenue fund, Street Maintenance Fund, to ensure the funds collected are used for street maintenance activities. Furthermore, it sets the recovery rate of the street maintenance fee at 26.35% of the current system cost or \$1.70 per month per single family equivalent.

While the ordinance will become effective immediately, the implementation phase will take approximately 6 months to properly integrate the new fee into the billing system. The collection of this fee will start in the July 2019 billing cycle.

THE ALTERNATIVES CONSIDERED:

The alternatives considered are as follows:

1. Reconsider the previous motion of direction regarding street maintenance funding and continue discussion on the topic.
2. Adopt the ordinance establishing a Street Maintenance Fund and Street Maintenance Fee.

Which alternative is recommended? Why?

Alternative 2 is recommended because this alternative was selected by a motion of direction during a City Council workshop on November 13, 2018.

CONFORMITY TO CITY POLICY:

This conforms to all state, federal, and local policies.

FINANCIAL IMPACT:

What is the amount of the expenditure in the current fiscal year? For future years?

This item is estimated to generate a revenue of \$1,639,402 annually.

Is this a one-time or recurring expenditure?

This is a recurring revenue.

Is this expenditure budgeted?

This revenue is not contained in the adopted budget.

If not, where will the money come from?

N/A

Is there a sufficient amount in the budgeted line-item for this expenditure?

N/A

RECOMMENDATION:

City staff recommends that the City Council approve the ordinance amending Chapter 25, Streets, Sidewalks, and Miscellaneous Public Places by establishing a Street Maintenance Fund and providing for collection of street maintenance fees.

DEPARTMENTAL CLEARANCES:

Public Works
Finance
City Attorney

ATTACHED SUPPORTING DOCUMENTS:

Ordinance

AN ORDINANCE AMENDING CHAPTER 25, STREETS, SIDEWALKS, AND MISCELLANEOUS PUBLIC PLACES BY ESTABLISHING A STREET MAINTENANCE FUND AND PROVIDING FOR COLLECTION OF STREET MAINTENANCE FEES; PROVIDING FOR EXEMPTIONS AND ADJUSTMENTS FROM STREET MAINTENANCE FEES; PROVIDING A REPEALER CLAUSE; PROVIDING FOR A SEVERABILITY CLAUSE; PROVIDING FOR A SAVINGS CLAUSE; PROVIDING FOR A PENALTY; PROVIDING FOR PUBLICATION AND AN EFFECTIVE DATE.

WHEREAS, the City of Killeen, Texas is a home-rule city acting under its charter adopted by the electorate pursuant to Article XI, Section 5 of the Texas Constitution and Chapter 9 of the Local Government Code; and,

WHEREAS, the City Council of the City of Killeen deems the continued operation and functionality of the City’s transportation infrastructure to be of vital importance to the protection of the public health, safety, and welfare of its citizens; and,

WHEREAS, the City of Killeen has determined that in order to protect the citizenry from the deterioration of the quality and safety of the road system which they rely upon and use on a regular basis and to provide a properly maintained road system, it is necessary and in the best interest of the public health and safety to establish a Street Maintenance Fund; and,

WHEREAS, the City of Killeen will establish a schedule of Street Maintenance fees; and,

WHEREAS, the City of Killeen will offer the street maintenance service on nondiscriminatory, reasonable and equitable terms,

NOW THEREFORE, BE IT ORDAINED BY THE CITY COUNCIL OF THE CITY OF KILLEEN, TEXAS:

SECTION I. That Chapter 25, Article VII of the City of Killeen Code of Ordinances is hereby amended by adding the following sections to read as follows:

ARTICLE VII. STREET MAINTENANCE FEE

Sec. 25-225. Definitions.

In this Article:

Benefitted property means a residence; a business; or a lot or parcel on which improvements have been constructed and that generates motor vehicle trips.

Monthly street maintenance cost per unit means the annual cost of street maintenance and operations including related materials, supplies, contracted treatments, pavement, concrete, signs, signals, marking, salaries, and equipment, and not including capital expenses such as existing debt, divided by the total number of single family equivalents divided by twelve months. The total number of single-family equivalents is total units within the City multiplied by each corresponding single-family equivalent.

Non-residential benefitted property means benefitted property not defined as residential benefitted property under this article. Non-residential property shall include, but not be limited to, property being used for the following purposes: commercial, industrial, institutional, lodging, medical, office, or religious.

Residential benefitted property means a single-family residence, modular home, townhouse, two-family housing, multi-family housing, mobile home, travel trailer, or manufactured home.

Street Maintenance fee means the fee established by this article.

Transportation system means the structures, streets, rights-of-way, bridges, alleys, and other facilities within the city limits that are dedicated to the use of vehicular traffic; the maintenance and repair of those facilities; and the operation and administration of such maintenance and repair.

Unit means a unit of measurement equaling:

- (a) Residential benefitted property: 1 per dwelling unit; OR

(b) Non-residential benefitted property: 1 per 1,000 square feet of improvements designated as living area/floor area as applicable in the records of the Bell County Appraisal District; OR

(c) Hotel/Motel: 1 per room; OR

(d) Self-Service Car Wash: 1 per stall.

Single-Family Equivalent is the equivalent number of trips per any other land use to single-family land use and is the principle basis of service measurement derived from trip generation rates, pass by percentages, and trip lengths published by the Institute of Transportation Engineers. The single-family equivalents of the following uses per unit are:

1. Single-Family Detached Housing Dwelling Unit	1.00
2. Multi-Family Housing (Low-Rise) Dwelling Unit	0.57
3. Multi-Family Housing (Mid-Rise) Dwelling Unit	0.44
4. Mobile Home Dwelling Unit	0.47
5. Assisted Living 1,000 SF GFA	0.49
6. Intermodal Truck Terminal 1,000 SF GFA	2.31
7. General Light Industrial 1,000 SF GFA	0.78
8. Industrial Park 1,000 SF GFA	0.49
9. Manufacturing 1,000 SF GFA	0.83
10. Warehousing 1,000 SF GFA	0.23
11. Mini-Warehouse 1,000 SF GFA	0.21
12. Hotel Room	0.50
13. Motel / Other Lodging Facilities Room	0.31
14. Multipurpose Recreational Facility 1,000 SF GFA	2.84
15. Bowling Alley 1,000 SF GFA	0.92
16. Adult Cabaret 1,000 SF GFA	2.32
17. Ice Skating Rink 1,000 SF GFA	1.05
18. Health/Fitness Club 1,000 SF GFA	2.74
19. Athletic Club 1,000 SF GFA	4.99
20. Recreational Community Center 1,000 SF GFA	1.83
21. Elementary School 1,000 SF GFA	1.01
22. Middle School/Junior High School 1,000 SF GFA	0.88
23. High School 1,000 SF GFA	0.72
24. Private School (K-8) 1,000 SF GFA	4.83
25. Junior / Community College 1,000 SF GFA	1.37
26. Church 1,000 SF GFA	0.24
27. Mosque 1,000 SF GFA	2.09
28. Day Care Center 1,000 SF GFA	4.60
29. Museum 1,000 SF GFA	0.13
30. Nursing Home 1,000 SF GFA	0.44
31. Clinic 1,000 SF GFA	2.42
32. Animal Hospital/Veterinary Clinic 1,000 SF GFA	1.83
33. General Office Building 1,000 SF GFA	0.85
34. Corporate Headquarters Building 1,000 SF GFA	1.03
35. Single Tenant Office Building 1,000 SF GFA	1.26

36. Medical-Dental Office Building 1,000 SF GFA	2.56
37. Office Park 1,000 SF GFA	0.98
38. Construction Equipment Rental Store 1,000 SF GFA	0.82
39. Building Materials and Lumber Store 1,000 SF GFA	1.70
40. Free-Standing Discount Superstore 1,000 SF GFA	2.53
41. Variety Store 1,000 SF GFA	3.72
42. Free-Standing Retail Store 1,000 SF GFA	2.79
43. Hardware/Paint Store 1,000 SF GFA	1.63
44. Nursery (Garden Center) 1,000 SF GFA	4.01
45. Shopping Center 1,000 SF GLA	2.07
46. New and Used Car Sales 1,000 SF GFA	2.38
47. Recreational Vehicle Sales 1,000 SF GFA	0.61
48. Automobile Parts Sales 1,000 SF GFA	2.22
49. Tire Store 1,000 SF GFA	2.28
50. Tire Superstore 1,000 SF GFA	1.20
51. Supermarket 1,000 SF GFA	4.88
52. Convenience Market (Open 24 Hours) 1,000 SF GFA	19.85
53. Convenience Market w/ Gasoline Pumps 1,000 SF GFA	13.83
54. Discount Supermarket 1,000 SF GFA	5.46
55. Home Improvement Superstore 1,000 SF GFA	1.11
56. Office Supply Superstore 1,000 SF GFA	2.29
57. Discount Home Furnishing Superstore 1,000 SF GFA	1.30
58. Department Store 1,000 SF GFA	1.13
59. Apparel Store 1,000 SF GFA	3.40
60. Pharmacy/Drugstore w/o Drive-through window 1,000 SF GFA	3.30
61. Pharmacy/Drugstore w/ Drive-through window 1,000 SF GFA	4.33
62. Furniture Store 1,000 SF GFA	0.20
63. Walk-In Bank 1,000 SF GFA	3.05
64. Drive-In Bank 1,000 SF GFA	5.31
65. Hair Salon 1,000 SF GFA	0.43
66. Drinking Place 1,000 SF GFA	3.83
67. Sit Down Restaurant 1,000 SF GFA	2.58
68. High Turnover (Sit-Down) Restaurant 1,000 SF GFA	3.29
69. Fast Food Restaurant without Drive-Thru Window 1,000 SF GFA	8.38
70. Fast Food Restaurant with Drive-Thru Window 1,000 SF GFA	9.66
71. Coffee/Donut Shop without Drive-through Window 1,000 SF GFA	2.36
72. Coffee/Donut Shop with Drive-Thru Window 1,000 SF GFA	2.82
73. Quick Lubrication Vehicle Shop 1,000 SF GFA	4.14
74. Automobile Care Center 1,000 SF GFA	1.48
75. Automobile Parts & Service Center 1,000 SF GFA	1.00
76. Self-Service Car Wash Stall	0.49
77. Automated Car Wash 1,000 SF GFA	1.00

User or utility customer means the person who is responsible for the payment of charges on a City utility meter for a benefitted property.

Sec. 25-226. Creation of Street Maintenance Special Revenue Fund.

A separate fund, within the City's fund structure, shall be created as of the effective date of the ordinance, known as the Street Maintenance Special Revenue Fund, for the purpose of maintenance of the transportation system.

Such street maintenance revenues shall be used only for maintenance and operations costs of the transportation system. Money from sources other than the Street Maintenance fee may be deposited in the Street Maintenance Special Revenue Fund. An expenditure from the Street Maintenance Special Revenue Fund need not specifically relate to the property of a particular user from whom the Street Maintenance fee was collected.

Section 25-227. Administration; Calculation of Street Maintenance Costs; Review.

The City Manager, or designee, shall be responsible for the administration of this ordinance including, but not limited to, creating a policy for the administration of the Street Maintenance Fund and the Street Maintenance fee; enacting any procedures necessary for the administration of the Street Maintenance fees and the consideration of petitions for exemption or adjustment; developing maintenance programs; and establishing transportation system criteria and standards for the operation of maintenance of the transportation system.

The estimated annual cost of the City's street maintenance and operations is \$6,221,640. The total single-family equivalents within the City limits equal 80,077.56. The monthly street maintenance cost per unit is \$6.47. ($\$6,221,640/80,077.56/12 \text{ months} = \6.47)

The annual street maintenance and operations costs and total single-family equivalents above shall be reviewed annually and updated as needed. A road condition survey shall be conducted every three years.

Section 25-228. Findings.

The City Council finds and determines the following:

- (1) It is appropriate that a benefitted property pay the prorated annual cost of the maintenance of the transportation system that can reasonably be attributed to the benefitted property.
- (2) The number of motor vehicle trips generated by a benefitted property may reasonably be used to estimate the prorated cost of the maintenance of the transportation system attributable to a benefitted property.
- (3) The size and use of a property may reasonably be used to estimate the number of motor vehicle trips generated by and single-family equivalent associated with the property.

- (4) Based on the best available data, the method of imposing the Street Maintenance fee reasonably prorates the cost of maintenance of the transportation system among benefitted properties.
- (5) If available, appraisal district property tax records may be relied on to determine the size of nonresidential benefitted property.
- (6) It is reasonable and equitable to derive trip generation rates or single-family equivalents for residential and nonresidential benefitted property as determined and published by the Institute of Transportation Engineers.
- (7) It is reasonable and equitable to assume that each utility meter in the service area serves a benefitted property.
- (8) It is reasonable to calculate the single-family equivalent and the monthly street maintenance cost components based on a representative year.
- (9) For purposes of this article, a property's use does not depend on the property's zoning. If a property fits more than one (1) category of land use, the City Manager, or designee, shall assign a composite single-family equivalent which will be calculated by combining the single-family equivalents for the existing land uses in percentages corresponding to the percentage of property used for each land use.

Sec. 25-229. Fee Established.

The city council hereby establishes a Street Maintenance fee intended to fund approximately 26.35 percent of annual street maintenance and operations costs. The Street Maintenance fee shall be calculated as provided herein and be paid by each City of Killeen utility customer within the city limits of Killeen, Texas.

Sec. 25-230. Calculation of Fee.

The Street Maintenance fee shall be calculated using the following formula:

$$\frac{\text{Monthly Street Maintenance Cost per unit} \times \text{Number of Units} \times \text{Single-Family Equivalent}}{\text{x Percentage Funded by Fee}} = \text{Monthly Bill}$$

For example, a similarly situated customer shall pay an amount equal to the following each month:

Single-family: $\$6.47 \times 1 \text{ unit} \times 1 \times .2635 = \1.70

Multifamily (Low-Rise): $\$6.47 \times 4 \text{ units} \times .57 \times .2635 = \3.89

Shopping Center: $\$6.47 \times 20 \text{ units (1 per 1,000 sq. ft.)} \times 2.07 \times .2635 = \70.58

Sec. 25-231. Allocation.

If one benefitted property is served by multiple meters or where one meter serves multiple benefitted properties, the City Manager, or designee, may determine the allocation of the fee among the users by any reasonable method that takes into account the relative contribution of each to traffic generation. In the absence of better information, the City Manager, or designee, may allocate the fee equally among the users.

Sec. 25-232. Exemptions.

- (A) This article does not apply to property owned by the City.
- (B) This article does not apply to a property that is vacant. The City Manager, or designee, may adopt any reasonable method to determine whether a property is vacant.
- (C) A user entitled to an exemption under this section must notify the City Manager, or designee, of the applicable exemption. A fee paid before the City Manager, or designee, is notified of an exemption may not be refunded.

Sec. 25-233. Adjustments.

- (A) A user may apply to the City Manager, or designee, for an adjustment in the user's monthly Street Maintenance fee if:
 - (1) the user disputes the category of land use used in calculating the fee for the owner's benefitted property; or
 - (2) the user believes the fee has been calculated in error.
- (B) The City Manager, or designee, may adjust the Street Maintenance fee for a user who has applied for an adjustment under this section according to best professional judgment.
- (C) A user who disagrees with a determination of the City Manager, or designee, under this section may apply for a hearing. The City Manager shall designate a hearing officer with authority to hold the hearing. The user requesting the hearing shall have the burden of proof to show by a preponderance of evidence that the adjustment should be granted. On completion of the hearing, the hearing officer shall recommend a disposition of the matter to the City Manager who may revise or reinstate the original determination.

Sec. 25-234. Billing and Payment.

- (A) Bills or statements for the Street Maintenance fee shall be rendered by the City for all properties subject to the fee. Bills shall be payable when rendered and shall be

considered as received by the customer/owner, whether actually received or not, when deposited in the United States mail, postage prepaid, addressed to the utility customer.

- (B) Bills shall be rendered monthly, and subject to late charges.
- (C) Bills shall be for services for the preceding month.
- (D) Street Maintenance fees shall be billed with the City's water and wastewater billings and shall be identified separately on the bill as a Street Maintenance fee.

Sec. 25-235. Recovery of Unpaid Fees; Enforcement.

The City may recover a Street Maintenance fee that is not paid when due in an action at law.

Sec. 25-236. Liability.

This article does not imply that a benefitted property will be free from inadequately maintained roads, and does not create additional duties on the part of the City. This article does not waive the City's immunity under any law.

SECTION II. That all ordinances or resolutions or parts of ordinances or resolutions in conflict with the provisions of this ordinance are hereby repealed to the extent of such conflict.

SECTION III. That should any section or part of any section, paragraph or clause of this ordinance be declared invalid or unconstitutional for any reason, it shall not invalidate or impair the validity, force or effect of any other section or sections or part of a section or paragraph of this ordinance.

SECTION IV. That the Code of Ordinances of the City of Killeen, Texas, as amended, shall remain in full force and effect, save and except as amended by this ordinance.

SECTION V. That this ordinance shall be effective on December 12, 2018.

PASSED AND APPROVED at a regular meeting of the City Council of the City of Killeen, Texas, this 11th day of December, 2018, at which meeting a quorum was present, held in accordance with the provisions of V.T.C.A., Government Code, §551.001 *et seq.*

APPROVED

Jose L. Segarra, MAYOR

ATTEST:

APPROVED AS TO FORM:

Lucy C. Aldrich, CITY SECRETARY

Kathryn H. Davis, CITY ATTORNEY

ORD _____

Date: _____



STREET MAINTENANCE FEE

OR-18-017

December 4, 2018

Background

2

- City Council was briefed on Street Maintenance Funding on October 23, November 6, and November 13.
- On November 13, City Council directed staff to prepare an ordinance establishing a Street Maintenance Fee and Street Maintenance Fund to collect approximately \$1.6M annually.
- This ordinance establishes a street maintenance fee for \$1.70 per SFE per month.

Formula

3

- $MMC \times N \times SFE \times \% \text{ Funded} = \text{Monthly Bill}$
 - ▣ $MMC = \text{Monthly Maintenance Cost per Unit } (\$6.47)$
 - ▣ $N = \text{Number of Units}$
 - 1 SF Home, 1,000 SF gross floor area, 1 stall (car wash), 1 room (hotel/motel)
 - ▣ $SFE = \text{Single Family Equivalent}$
 - Comparison of the traffic generated by a use to a typical single family home
 - Defined in Section 25-225
 - ▣ $\% \text{ Funded} = \text{amount to be recovered by fee } (26.35\% \text{ of } \$6,221,640 \text{ or } \$1,639,402)$
 - ▣ $\text{Monthly Bill} = \text{Amount due on a monthly basis}$

Implementation

4

- Ordinance will be effective immediately upon adoption.
- The implementation process will take approximately six (6) months.
 - Develop standard operating procedures for new accounts, billing, appeals, etc.
 - Data transfer for +/-50,000 accounts.
 - Create coding module for billing system.
 - Ensure proper land use codes have been assigned.
 - Allow citizens and businesses an opportunity to plan accordingly for the new fee.
- The collection of the fee will begin in July 2019.

Alternatives

5

- Reconsider the previous motion of direction regarding street maintenance funding and continue discussion on the topic.
- Adopt the ordinance establishing a Street Maintenance Fund and Street Maintenance Fee.

Recommendation

6

- City staff recommends that the City Council approve the ordinance amending Chapter 25, Streets, Sidewalks, and Miscellaneous Public Places by establishing a Street Maintenance Fund and providing for collection of street maintenance fees.



City of Killeen

Legislation Details

File #: PH-18-037 **Version:** 1 **Name:** Zoning 18-23
Type: Ordinance/Public Hearing **Status:** Public Hearings
File created: 11/16/2018 **In control:** City Council Workshop
On agenda: 12/4/2018 **Final action:**

Title: HOLD a public hearing and consider an ordinance by Reece's Creek Group, L.C. (Case #Z18-23) to rezone Lots 3A-8A, Block 3, University Village, Second Amendment and Lots 10-13, Block 3, University Village, from University District ("UD") with a Conditional Use Permit (C.U.P.) for "RT-1" (Residential Townhouse Single-Family District) to University District ("UD") with a Conditional Use Permit (C.U.P.) for "R-2" (Two-Family Residential District). The properties are addressed as 6700, 6702, 6704, 6706, 6708 and 6710 Student Union Drive and 6701, 6703, 6705 and 6707 University Village Way, Killeen, Texas.

Sponsors: Planning & Development Dept

Indexes:

Code sections:

Attachments: [Staff Report](#)
[Zoning Map and Notification Area](#)
[Minutes](#)
[Ordinance](#)
[Pharr vs Tippitt](#)
[Amending Plat Exhibit](#)
[Presentation](#)

Date	Ver.	Action By	Action	Result
------	------	-----------	--------	--------



STAFF REPORT

DATE: December 4, 2018

TO: Ronald L. Olson, City Manager

FROM: Dr. Ray Shanaa, AICP, Exec. Dir. of Planning and Development Services

SUBJECT: Zoning Case #Z18-23 University District ("UD") with a Conditional Use Permit (C.U.P.) for "RT-1" (Residential Townhouse Single-Family District) to University District ("UD") with a Conditional Use Permit (C.U.P.) for "R-2" (Two-Family Residential District)

Background and Findings

This request is submitted by Reece's Creek Group, L.C. to rezone Lots 3A-8A, Block 3, University Village, Second Amendment and Lots 10-13, Block 3, University Village, from University District ("UD") with a Conditional Use Permit (C.U.P.) for "RT-1" (Residential Townhouse Single-Family District) to University District ("UD") with a Conditional Use Permit (C.U.P.) for "R-2" (Two-Family Residential District). The properties are addressed as 6700, 6702, 6704, 6706, 6708 and 6710 Student Union Drive and 6701, 6703, 6705 and 6707 University Village Way, Killeen, Texas.

University District Descriptions:

- (a) A building or premises in the University District shall only be used for uses permitted in the "B-2" district, subject to the provisions of this division, and for the following purposes:
- (1) Bank, savings and loan or other financial institution excluding credit access businesses as defined by the Texas Finance Code.
 - (2) Hospital, home or center for the acute or chronic ill, or assisted living facility.
 - (3) Household appliance sales and repair service, no outside storage.
 - (4) Retail bakery or confectionery: engaged in preparation, baking, cooking, selling and delivery of products.
 - (5) Business day care.
 - (6) Bowling alleys.
 - (7) Cleaning or laundry (self-service).
 - (8) Cleaning or laundry, (pick-up station).
 - (9) Florist, garden shop, greenhouse or nursery office (retail): no growing of plants, shrubs or trees out-of-doors on premises; no outside display or storage unless behind the required front yard or the actual setback of the principal building, whichever is greater.
 - (10) General food products, retail sales, such as supermarkets, butcher shops, dairy stores, seafood sales or health food sales.
 - (11) Cafeteria or catering service.
 - (12) Office, general business.
 - (13) Restaurant or café (with drive-thru or dine in service).
 - (14) Tennis, swim club, health club or gym.

- (15) Small animal clinic or pet grooming shop.
 - (16) Hotel or motel.
 - (17) Job printing.
 - (18) Gasoline service station, auto laundry, car wash, or oil / lube service station.
 - (19) Retail sales of new auto parts: no outside storage.
 - (20) A customarily incidental use: sale of beer and/or wine for off-premises consumption only shall be considered a customarily incident use in this district.
 - (21) Theaters of general release.
 - (22) A restaurant permitted to offer alcoholic beverages for sale operating under the rules and regulations promulgated by the Texas Alcoholic Beverage Commission, as amended, and in accordance with chapter 31, division 16, restaurant and alcohol sales district, as amended.
 - (23) Package stores operating under the rules and regulations promulgated by the Texas Alcoholic Beverage Commission, as amended, and in accordance with chapter 31, division 12A, district B-3A, local business and alcohol sales district, as amended.
 - (24) Mixed-use development, being located nine hundred fifty (950) feet to one thousand five hundred (1,500) feet east of the east right-of-way of State Highway 195, and for a distance of approximately seventy-six hundred (7,600) feet south of the intersection of State Highway 195 and State Highway 201, for the commercial and residential use of a building, set of buildings, or neighborhood, where the first floor is designed, constructed and used for commercial use only while allowing access to residential uses.
 - (25) Art gallery, book store or library.
- (b) Any conflict between this district and the districts incorporated herein, or the regulations provided by the other districts, shall be resolved so that the most stringent provision shall control.

Two- Family Residential District Descriptions:

- (a) Uses. A building or premises in a district "R-2" Two-Family Residential District shall be used only for the following purposes:
- (1) Any use permitted in district "R-1".
 - (2) Two-Family dwellings.

Additionally, Section 31-441 of the Killeen Code of Ordinances provides for a Conditional Use Permit (C.U.P.) that states that the City Council by an affirmative majority vote may by ordinance grant a Conditional Use Permit as provided in section 31-456 of this chapter for any residential or business land use for a specific parcel in the overlay district and may impose appropriate conditions and safeguards to assure that these land uses are compatible with and appropriate for locations adjacent to the future four-year university. Conditional use permits granted shall be considered permanent provided the property owner remains in continuous compliance with any conditions or safeguards imposed.

Property Specifics

Applicant / Property Owner: Reece's Creek Group, L.C.

Property Location: The properties are addressed as 6700, 6702, 6704, 6706, 6708 and 6710 Student Union Drive and 6701, 6703, 6705 and 6707 University Village Way, Killeen, Texas.

Legal Description: Lots 3A-8A, Block 3, University Village, Second Amendment and Lots 10-13, Block 3, University Village.

Zoning/ Plat Case History:

- The property was rezoned from University District ("UD") to University District ("UD") with a Conditional Use permit (C.U.P.) for "RT-1" (Residential Townhouse Single-Family District) on August 28, 2012, per Ordinance No. 12-057.
- The properties addressed as 6700, 6702, 6704, 6706, 6708 and 6710 Student Union Drive were most recently replatted as Lots 3A-8A, Block 3, University Village, Second Amendment, which was filed for record on December 19, 2016 as Plat #155, Plat Records of Bell County, Texas. The properties addressed as 6701, 6703, 6705 and 6707 University Village Way are platted as Lots 10-13, Block 3, University Village, which was filed for record on November 29, 2012 in Cabinet D, Slide 376C, 376D, Plat Records of Bell County, Texas.

Character of the Area: The University Village community consists of townhomes and duplexes.

Existing Land Use(s) on the Property: The property is vacant.

Historic Properties: None

Community Infrastructure and Environmental Assessment

Water, Sewer and Drainage Services: Adequate potable water and sanitary sewer capacity is currently available to the tract.

Provider: City of Killeen

Within Service Area: Yes

Transportation (existing conditions): Both Student Union Drive and University Village Way are built as 60' local streets.

Proposed Improvements: No additional right-of-way improvements are proposed at this time.

Proposed Traffic Generation: One duplex or two-family residential unit typically generates 20 daily trips [note-this data is sourced from the Institute of Transportation Engineer (ITE) Trip Generation Rates-9th Edition, provided through Spack Consulting].

Environmental Assessment: There are no known wetlands on this property. There are no known environmental issues with the existing or proposed development for this site.

Land Use Analysis

Land Use Plan: This area is designated as 'Suburban Commercial' on the Future Land Use Map (FLUM) of the Comprehensive Plan.

Plan Recommendation: The 'Suburban Commercial' designation encompasses a range of commercial, retail and service uses, at varying scales and intensities depending on the site. Characteristics of this designation are their close proximity to residential areas, reduced site coverage and the exclusion of some auto-oriented uses.

Consistency: The zoning proposal is consistent with the Comprehensive Plan. The City Council may grant a Conditional Use Permit (C.U.P.) for any residential or business land use for a specific parcel within the University District ("UD").

Public Notification: Staff notified sixteen (16) surrounding property owners within 400 feet of the subject property regarding this request. As of the date of this report staff has received no responses.

THE ALTERNATIVES CONSIDERED:

Which alternative is recommended?

Staff is not recommending any alternatives.

Why?

Staff supports the request to rezone the properties.

CONFORMITY TO CITY POLICY:

This zoning request conforms to the City's policy and procedures as detailed in Chapter 31 of the Killeen Code of Ordinances.

FINANCIAL IMPACT:

What is the amount of the expenditure in the current fiscal year? For future years?

This zoning request does not involve the expenditure of city funds.

Is this a one-time or recurring expenditure?

This is not applicable.

Is this expenditure budgeted?

This is not applicable.

If not, where will the money come from?

This is not applicable.

Is there a sufficient amount in the budgeted line-item for this expenditure?

This is not applicable.

RECOMMENDATION:

The Planning and Zoning Commission recommended approval of the applicant's request by a vote of 5 to 0. It shall be noted that there is no minimum lot area requirement within the University District and the submitted amending plat illustrates that the applicant will meet all "R-2" applicable setbacks. It shall be noted that all other applicable University District architectural design standards and landscaping requirements.

DEPARTMENTAL CLEARANCES:

This item has been reviewed by the Planning and Legal staff.

ATTACHED SUPPORTING DOCUMENTS:

1. Zoning Map and Notification Area
2. Minutes
3. Ordinance
4. Pharr v. Tippitt
5. Amending Plat Exhibit

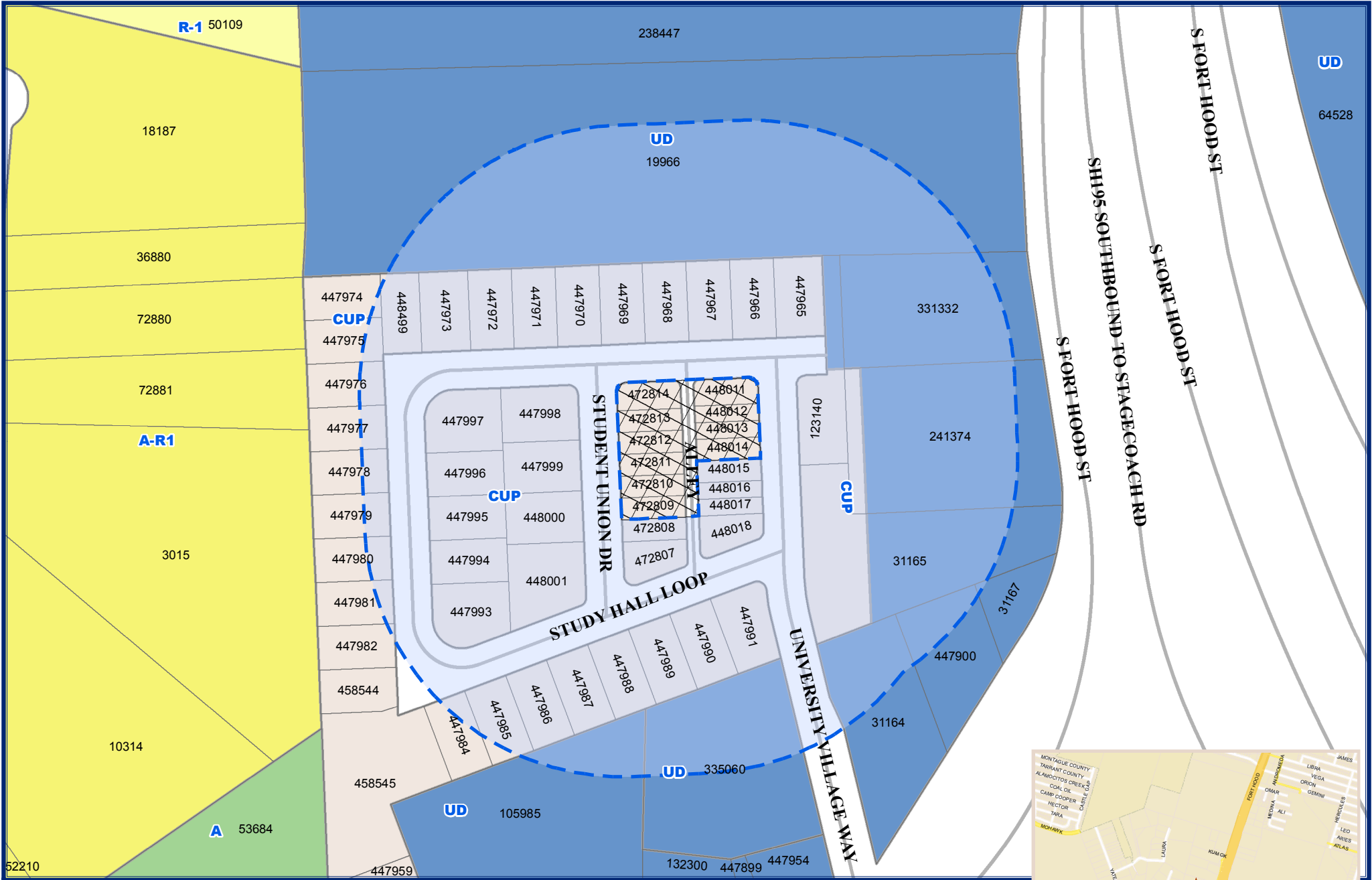

Zoning Case Notification Plan
Case Z-2018-23

Council District: 1
 ZONING FROM: UD W/CUP ZONING TO: UD W/CUP FOR R-2
 1 inch = 200 feet

Subject Property Legal Description: UNIVERSITY VILLAGE, BLOCK 003, LOTS 10 TO 13;
 UNIVERSITY VILLAGE SECOND AMENDMENT (L1-9 B3), BLOCK 003, LOTS 3A TO 8A

Legend

- 400 Ft Notification Area
- Zoning Case Location
- Killen City Limits
- Bell County Area

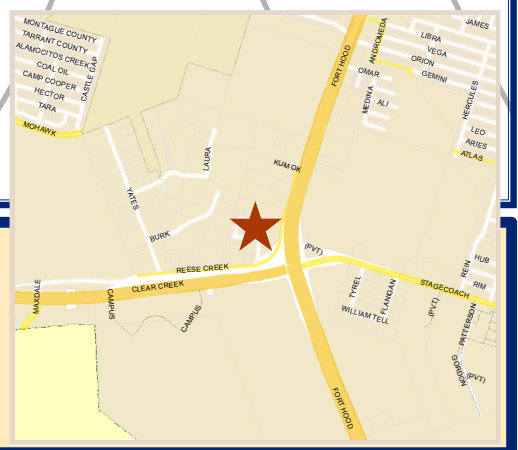

**MINUTES
PLANNING AND ZONING COMMISSION MEETING
NOVEMBER 19, 2018**

**CASE #Z18-23
“UD” w/ “CUP” to “UD” w/ “CUP” for “R-2”**

HOLD a public hearing and consider a request submitted by Mitchell & Associates, Inc. on behalf of Reece’s Creek Group, L.C., (Case#Z18-23) to rezone Lots 3A-8A Block 3, University Village, Second Amendment and Lots 10-13, Block 3, University Village, from University District (“UD”) with a Conditional Use Permit (C.U.P.) for “RT-1” (Residential Townhouse Single-Family District) to University District (“UD”) with a Conditional Use Permit (C.U.P.) to allow “R-2” (Two-Family Residential District) residential use. The properties are addressed as 6700, 6702, 6704, 6706, 6708 and 6710 Student Union Drive and 6701, 6703, 6705, and 6707 University Village Way, Killeen, Texas.

Commissioner Cooper requested staff comments.

Mr. McIlwain stated this area is designated as ‘Suburban Commercial’ on the Future Land Use Map (FLUM) of the Comprehensive Plan. The ‘Suburban Commercial’ designation encompasses a range of commercial retail and service uses, at varying scales and intensities depending on the site. Characteristics of this designation are their close proximity to residential areas, reduced site coverage and the exclusion of some auto-oriented uses.

Mr. McIlwain also noted that the zoning proposal is consistent with the Comprehensive Plan. The City Council may grant a Conditional Use Permit (C.U.P.) for any residential or business land use for a specific parcel within the University District (“UD”).

Mr. McIlwain stated that staff notified sixteen (16) surrounding property owners within 400 feet of the subject property regarding this request and has received no responses.

Staff recommends approval of the applicant’s request. It shall be noted there is no minimum lot area requirement within the University District and the submitted amending plat illustrates that the applicant will meet all “R-2” applicable setbacks. It shall be noted that all other applicable University District architectural design standards and landscaping requirements will be met.

No one was present to represent the request. The Commission voted 4 to 1 to hear the case without a representative.

Commissioner Cooper opened the public hearing.

With no one requesting to speak, the public hearing was closed.

Commissioner Latham motioned to recommend approval of the request as recommended by staff. Commissioner Gukeisen seconded, and the motion passed by a vote of 5 to 0.

Commissioner Cooper stated that the request will be forwarded to City Council with a recommendation to approve.

ORDINANCE _____

AN ORDINANCE AMENDING THE ZONING ORDINANCE OF THE CITY OF KILLEEN CHANGING THE ZONING OF LOTS 3A-8A, BLOCK 3, UNIVERSITY VILLAGE, SECOND AMENDMENT AND LOTS 10-13, BLOCK 3, UNIVERSITY VILLAGE, FROM UNIVERSITY DISTRICT “UD” WITH A CONDITIONAL USE PERMIT (C.U.P.) FOR “RT-1” (RESIDENTIAL TOWNHOUSE SINGLE-FAMILY DISTRICT) TO UNIVERSITY DISTRICT “UD” WITH A CONDITIONAL USE PERMIT (C.U.P.) FOR “R-2” (TWO-FAMILY RESIDENTIAL DISTRICT); PROVIDING A SAVINGS CLAUSE; PROVIDING FOR THE REPEAL OF CONFLICTING PROVISIONS; PROVIDING FOR AN EFFECTIVE DATE.

WHEREAS, Reece’s Creek Group, L.C. has presented to the City of Killeen a request for amendment of the zoning ordinance of the City of Killeen by changing the classification of Lots 3A-8A, Block 3, University Village, Second Amendment and Lots 10-13, Block 3, University Village, from University District (“UD”) with a Conditional Use Permit (C.U.P.) for “RT-1” (Residential Townhouse Single-Family District) to University District (“UD”) with a Conditional Use Permit (C.U.P.) for “R-2” (Two-Family Residential District), said request having been recommended for approval by the Planning and Zoning Commission of the City of Killeen on the 19th day of November 2018, and due notice of the filing of said request and the date of hearing thereon was given as required by law, and hearing on said request was set for 5:00 P.M., on the 11th day of December 2018, at 210 W. Avenue C, Killeen, Texas;

WHEREAS, the City Council at said hearing duly considered said request, the action of the Planning and Zoning Commission and the evidence in support thereof, and the City Council being of the majority opinion that the applicant’s zoning request should be approved;

NOW, THEREFORE, BE IT ORDAINED BY THE CITY COUNCIL OF THE CITY OF KILLEEN:

SECTION I. That the zoning classification of Lots 3A-8A, Block 3, University Village, Second Amendment and Lots 10-13, Block 3, University Village, from University District (“UD”) with a Conditional Use Permit (C.U.P.) for “RT-1” (Residential Townhouse Single-Family District) to University District (“UD”) with a Conditional Use Permit (C.U.P.) for “R-2” (Two-Family Residential District). The properties are addressed as 6700, 6702, 6704, 6706, 6708 and 6710 Student Union Drive and 6701, 6703, 6705 and 6707 University Village Way, Killeen, Texas.

SECTION II. That should any section or part of this ordinance be declared unconstitutional or invalid for any reason, it shall not invalidate or impair the validity, force, or effect of any other section or parts of this ordinance.

SECTION III. That all ordinances and resolutions, or parts thereof, in conflict with the provisions of this ordinance are hereby repealed to the extent of such conflict.

SECTION IV. That this ordinance shall take effect immediately upon passage of the ordinance.

PASSED AND APPROVED at a regular meeting of the City Council of the City of Killeen, Texas, this 11th day of December 2018, at which meeting a quorum was present, held in accordance with the provisions of V.T.C.A., Government Code, §551.001 et seq.

APPROVED:

Jose L. Segarra, MAYOR

ATTEST:

Lucy C. Aldrich, CITY SECRETARY

APPROVED AS TO FORM

Kathryn H. Davis, CITY ATTORNEY
Case #18-23, Ord. #18-____

CONSIDERATIONS

Texas Supreme Court in Pharr v. Tippitt, 616 S. W 2nd 173 (Tex 1981) established general guidelines which the Planning and Zoning Commission and City Council should take into consideration when making their respective recommendation and decision on a zoning request.

A. General Factors to Consider:

Is the request in accordance with the comprehensive plan?

Is the request designed to lessen congestion in the streets; secure safety from fire, panic or other dangers; promote health and the general welfare; provide adequate light and air; prevent the overcrowding of land; avoid undue concentration of population; or facilitate the adequate provision of transportation, water, sewers, schools, parks and other public requirements?

What if any, is the nature and degree of an adverse impact upon neighboring lands?

The suitability or unsuitability of the tract for use as presently zoned.

Whether the amendment bears a substantial relationship to the public health, safety, morals or general welfare or protects and preserves historical and cultural places and areas.

Whether there is a substantial public need or purpose for the new zoning.

Whether there have been substantially changed conditions in the neighborhood.

Is the new zoning substantially inconsistent with the zoning of neighboring lands? (Whether the new zoning is more or less restrictive.)

The size of the tract in relation to the affected neighboring lands – is the tract a small tract or isolated tract asking for preferential treatment that differs from that accorded similar surrounding land without first proving changes in conditions?

Any other factors which will substantially affect the health, safety, morals or general welfare.

B. Conditional Use Permit (if applicable)

Whether the use is in harmonious with and adaptable to buildings, structures and use of abutting property and other property in the vicinity of the premises under construction.

C. Conditions to Consider

1. Occupation shall be conducted only by members of family living in home.
2. No outside storage or display
3. Cannot change the outside appearance of the dwelling so that it is altered from its residential character.
4. Cannot allow the performance of the business activity to be visible from the street.
5. Cannot use any window display to advertise or call attention to the business.
6. Cannot have any signs
7. No off-street parking or on-street parking of more than two (2) vehicles at any one time for business related customer parking.
8. No retail sales.
9. Length of Permit.

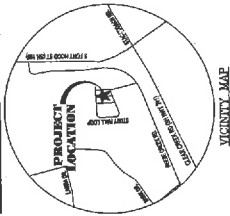
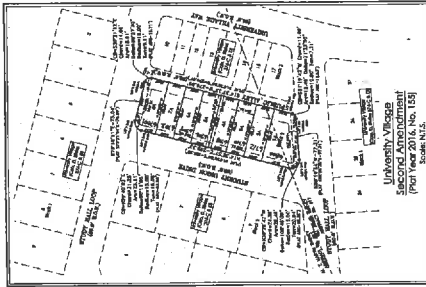
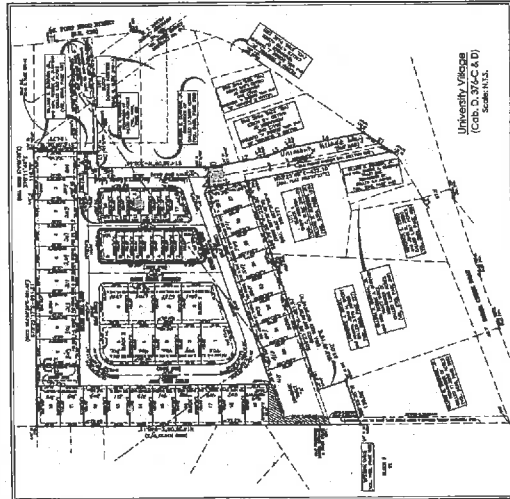

CURVE	BEARING	CHORD	LENGTH	BACKSIGHT	DELTA	FORSIGHT
C1	S87°00'00\"/>					

- NOTES:**
- All bearings are based upon the Texas Coordinate System (NAD 83 (CORS 93), Texas Central Zone as defined by the Texas Department of Transportation. All distances are surface distances. Combined scale factor: 1.001116.
 - All areas for corner markers with 1/2\"/>

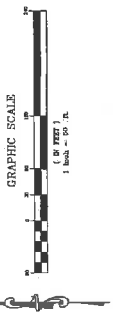
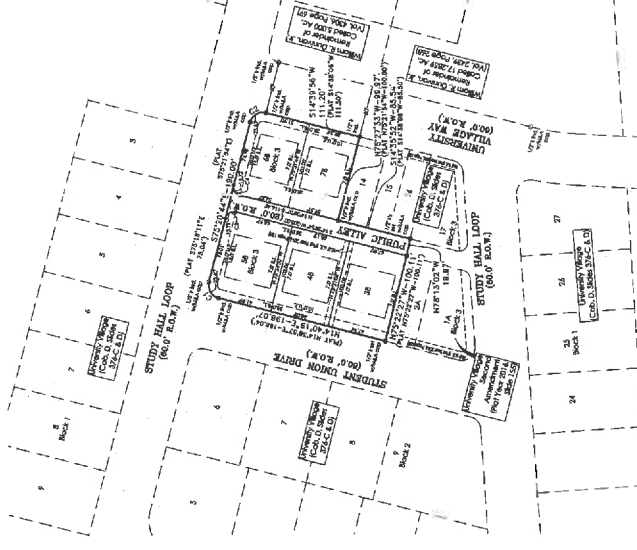

UNIVERSITY VILLAGE, THIRD AMENDMENT
 BEING AN AMENDING PLAT OF ALL OF LOTS 3, UNIVERSITY VILLAGE, SECOND AMENDMENT
 KILLEEN, BELL COUNTY, TEXAS

APPROVED this 14th day of October, 2018, by the Executive Director of Planning and Development Services of the City of Killeen, Texas, as follows:

 Executive Director of Planning and Development Services

APPROVED this 14th day of October, 2018, by the Executive Director of Planning and Development Services of the City of Killeen, Texas, as follows:

 Executive Director of Planning and Development Services

APPROVED this 14th day of October, 2018, by the Executive Director of Planning and Development Services of the City of Killeen, Texas, as follows:

 Executive Director of Planning and Development Services



MITCHELL & ASSOCIATES, INC.
 ENGINEERING & SURVEYING
 102 N. COLLETT
 KILLEEN, TEXAS 76541
 PHONE: (254) 834-5541
 FAX: (254) 834-2141
 U.S. & S. REGISTRATION NO. 00949-02

STATE MAP OF PROFESSIONAL SURVEYING REGISTRATION NO. 2017
 REGISTRATION NO. 00949-02

DATE: 10/15/18
 SHEET: 18/18
 BLOCK: 18/18
 LOT: 18/18

SHEET 18



ZONING CASE #Z18-23

“UD” with C.U.P. for “RT-1”
to “UD” with C.U.P. for “R-2”

PH-18-037

December 4, 2018

Case #Z18-23 “UD” with C.U.P. for “RT-1” to “UD” with C.U.P. for “R-2”

2

- Mitchell & Associates, Inc. submits this request on behalf of Reece’s Creek Group, L.C. to rezone Lots 3A-8A, Block 3, University Village, Second Amendment and Lots 10-13, Block 3, University Village, from University District (“UD”) with a Conditional Use Permit (C.U.P.) for “RT-1” (Residential Townhouse Single-Family District) to University District (“UD”) with a Conditional Use Permit (C.U.P.) for “R-2” (Two-Family Residential District).
- The properties are addressed as 6700, 6702, 6704, 6706, 6708 and 6710 Student Union Drive and 6701, 6703, 6705 and 6707 University Village Way, Killeen, Texas. The effect of this rezoning would revert the ten (10) existing townhouse lots to five (5) duplex lots.

Case #Z18-23 “UD” with C.U.P. for “RT-1” to “UD” with C.U.P. for “R-2”

3

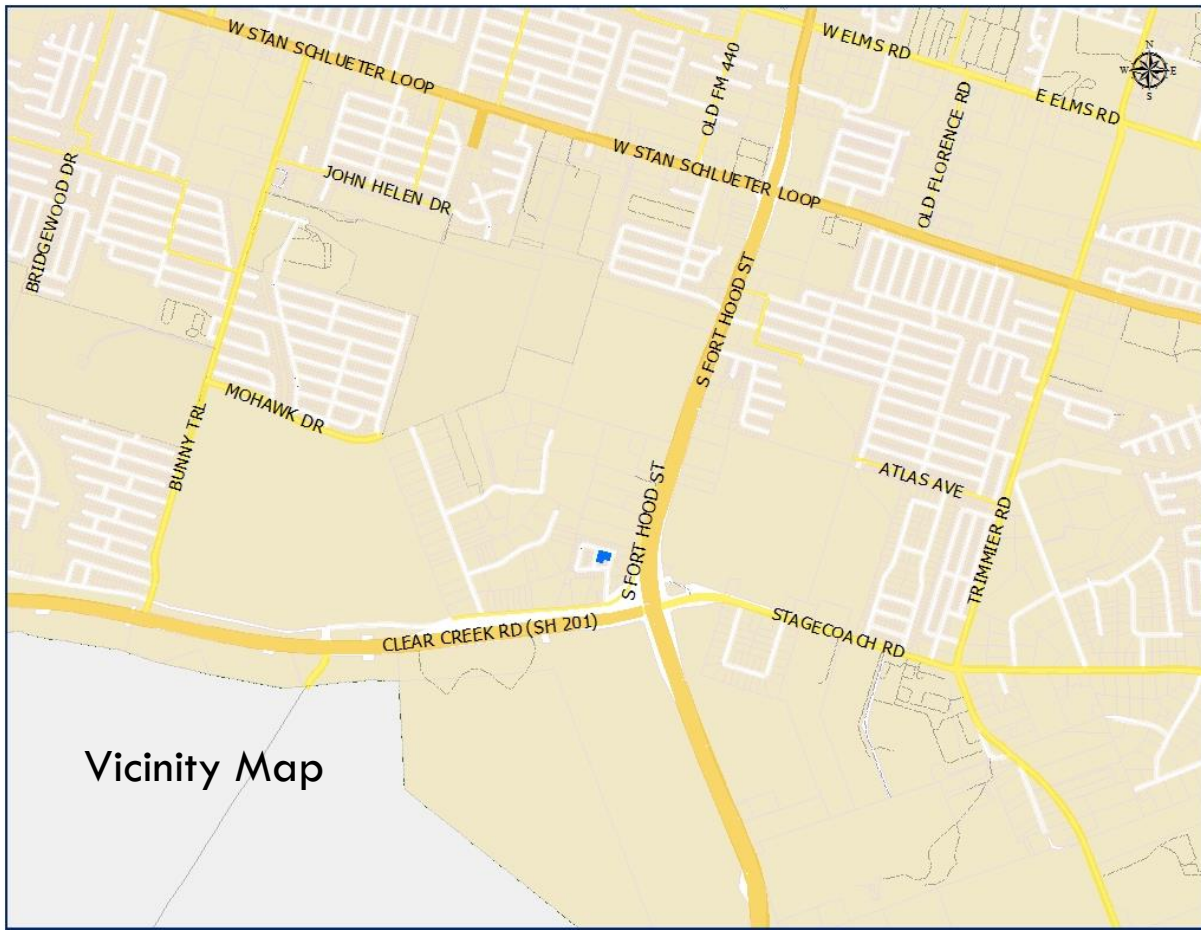

Case #Z18-23 "UD" with C.U.P. for "RT-1"
to "UD" with C.U.P. for "R-2"

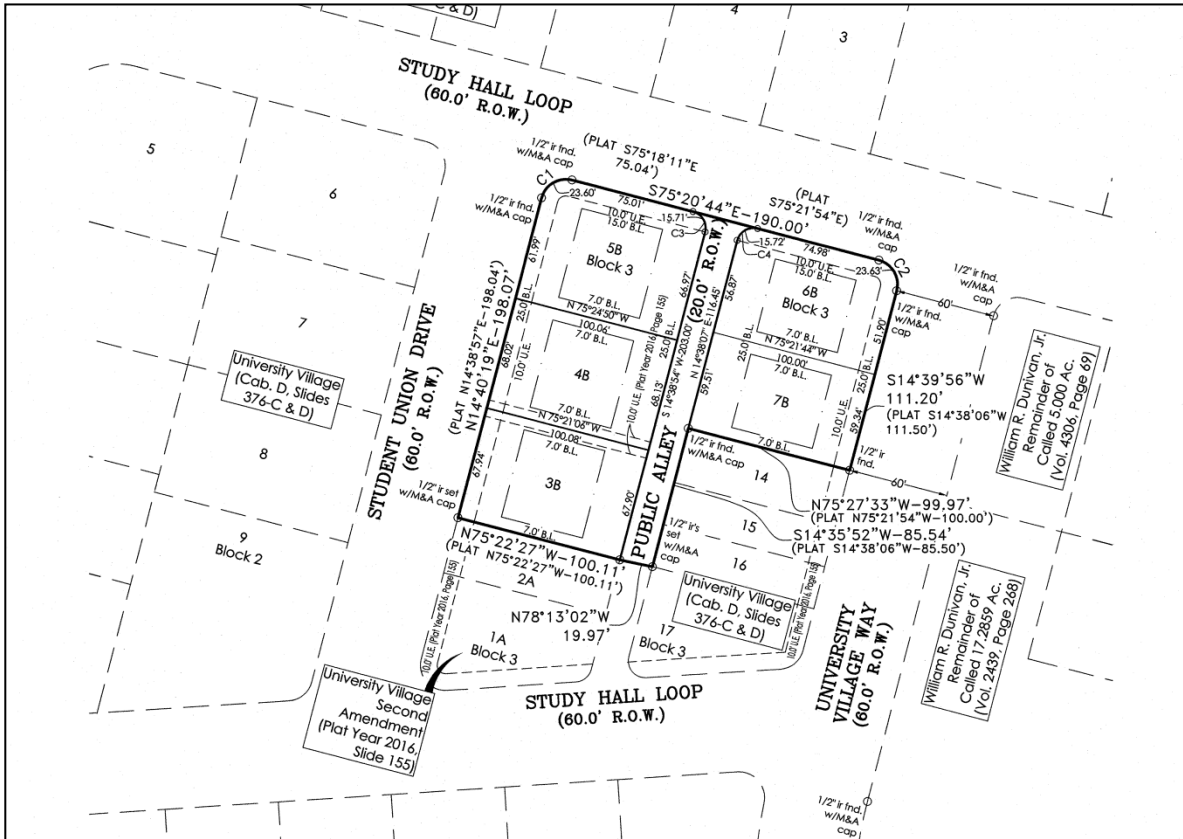

**Case #Z18-23 “UD” with C.U.P. for “RT-1”
to “UD” with C.U.P. for “R-2”**

5

□ **Current Conditions**



Case #Z18-23 “UD” with C.U.P. for “RT-1” to “UD” with C.U.P. for “R-2”

6

□ Current Conditions



Case #Z18-23 “UD” with C.U.P. for “RT-1” to “UD” with C.U.P. for “R-2”

7

□ Current Conditions



Case #Z18-23 “UD” with C.U.P. for “RT-1” to “UD” with C.U.P. for “R-2”

8

□ Current Conditions



Case #Z18-23 “UD” with C.U.P. for “RT-1” to “UD” with C.U.P. for “R-2”

- The property is designated as ‘Suburban Commercial’ on the Comprehensive Plan’s Future Land Use Map (FLUM). This designation encompasses a range of commercial retail and service uses, at varying scales and intensities depending on the site.
- The City Council may grant a Conditional Use Permit (C.U.P.) for any residential or business land use for a specific parcel within the University District (“UD”).
- Staff notified sixteen (16) surrounding property owners within 400 ft. of the subject site and has received no responses in support or opposition.

**Case #Z18-23 “UD” with C.U.P. for “RT-1”
to “UD” with C.U.P. for “R-2”**

- The Planning and Zoning Commission recommended approval of the applicant’s zoning request by a vote of 5 to 0.
- There is no minimal lot size within the University District.
- The applicant shall meet the “R-2” minimum setback requirements and all other applicable University District design standards and landscaping requirements.