

CITY OF KILLEEN
APPLICATION FOR FIREWORKS PUBLIC DISPLAY PERMIT



Name of Applicant: Magic Display Pyrotechnics

Address: 593 CR 4808

Telephone: 254-289-4791 Secondary #: _____

Applicant doing business as: () Individual, (✓) Partnership, () Corporation

DATE OF DISPLAY: Sat, 01 JUL 2023, Time: 9:30PM to 10:00PM

Location of Display (attach site plan): Community Center Park, Killeen, TX

Pyrotechnic operator licensed in Texas who will supervise the display:

Name: Mr. Joseph Strunz, License #: Texas FPO #2006642

Size and Number of Fireworks to be discharged: 12" (x2), 10" (x12), 8" (x18), 6" (x40), 5" (x60),
4" (x80), 3" (x300), 1" to 2" Multi-Shot (25s to 600s) Display Cakes (x12).

Manner and place of storage of fireworks prior to and during the display: Enclosed security trailer at
launching site, Community Center Park, Killeen, Texas.

Manufacturer of distributor licensed in Texas who is to supply the fireworks:

Name: Flying Phoenix Fireworks Corp, License #: 5-WY-013-51-1B-00321

Texas public Display permit number: Comes later by TDI State Fire Marshal Office

In applying for a fireworks public display permit, I certify that I am familiar with and will comply with Section 11-6 of the Killeen Code of Ordinances, Article 5.43-4 of the Texas Insurance Code, Chapter 591, of Title 27 of the Texas Administrative Code and NFPA 1123. I hereby authorize the Fire Marshal to enter, examine, and inspect any premises, building, room or establishment used in connection with the permit for which I am applying to determine compliance with the above provisions.

I understand that I must complete this application and return it to the City Manager's Office at least twenty-one (21) days in advance along with a diagram of the grounds on which the outdoor fireworks display is to be held showing the point at which the fireworks are to be discharged, the location of all buildings, highways and other lines of communication, the lines behind which the audience will be restrained, and the location of other possible overhead obstructions.

STRUNZ,JOSEPH.ANDREW. Digitally signed by
1088963411 STRUNZ,JOSEPH.ANDREW.1088963411
Date: 2023.01.04 09:15:29 -06'00'

Applicant's Signature

04 Jan 2023
Date

Joseph Strunz
Printed Name



State Fire Marshal's Office

PO Box 12107 | Austin, TX 78711 | 512-676-6800 | tdi.texas.gov/fire

Permit Application for Class B Fireworks (1.3G) Singular or Multiple Display

► Instructions

- Please print or type your answers.
- A public firework display permit may not be issued to anyone under 21 years of age.
- Your application must include a completed "Texas State Fire Marshal's Office Site Inspection Certification."
- Include all documents and information required by Chapter 2154 of the Texas Occupations Code and Section 34.800 of the Texas Administrative Code, Title 28, the Fireworks Rules.
- All fees are nonrefundable, except for overpayments from mistakes of law or fact.
- Send only one payment to cover all fees. Combine fee payments for multiple applications.
- Answer questions completely and truthfully. We may deny, suspend, or revoke your permit if you misrepresent or knowingly give wrong information on this application.

► Type of permit you're applying for **Fee (TDI code 570)**

- | | |
|--|-------|
| <input checked="" type="checkbox"/> Singular display | \$50 |
| <input type="checkbox"/> Multiple display | \$400 |

1. Permit holder information

Magic Display Pyrotechnics FX

Permit holder name (company or individual name)

593 CR 4808 Copperas Cove Texas 76522 Lampasas

Address City State ZIP County

254-289-4791

Phone (required)

Fax

joe@magicdisplayfireworks.com

Email (required)

Website (optional)

► **Applicant doing business as** (Mark only one)

Individual

Are you 21 years of age or older? Yes No

Partnership

Is each partner 21 years of age or older? Yes No

Corporation

Other (describe) _____

339-60-7159

IRS tax ID/Employer's identification number (EIN)

2. Information about the display

Sat, 1 July 2023

9:30 PM

Date of display

Time

City of Killeen "Community Center Park" 2201 E Veterans Memorial Blvd, Killeen, TX 76543

Address of display or exact location description

Sun, 2 July, 2023

9:30 PM

Alternate date of display

Time

City of Killeen "Community Center Park" 2201 E Veterans Memorial Blvd, Killeen, TX 76543

Address of alternate display or exact location description

► Pyrotechnic operator licensed in Texas who will be at the display site to supervise the display:

Joseph Strunz

FPO 2006642

Name

License number

Name

License number

Name

License number

Display aerial shells: 12" (x2), 10" (x12) 8" (x24), 6" (x70), 5" (x60), 4" (x80), 3" (x400).

Size and estimated number of 1.3G fireworks to be discharged

1" to 3" Multi-Shot (25s to 600s) Display Cakes (x12).

Other items (1.4G fireworks, flame effects, set pieces, etc.)

593 CR 4808, Copperas Cove, TX 76522, ATF approved storage magazines.

Manner and address of storage of fireworks **before** the display.

Setup day, secured and guarded in enclosed trailer 100' upwind from display site.

Manner and address of storage of fireworks **during** the display.

▶ Manufacturer or distributor licensed in Texas who is to supply the fireworks.

Flying Phoenix LLC

5-WY-013-51-1B-00321

Name

License number

3. Certification

I authorize the Texas State Fire Marshal or its representative to enter, examine, and inspect any premises, building, room, or establishment used by the company while engaged in the business to determine compliance with Chapter 2154 of the Texas Occupations Code and Section 34.800 of the Texas Administrative Code, Title 28, the Fireworks Rules.

I am familiar with and will comply with Chapter 2154 of the Texas Occupations Code and Section 34.800 of the Texas Administrative Code, Title 28, the Fireworks Rules.

I verify that the information on this application and its attachments are true and correct.

I understand that knowingly providing a false answer to any question or submitting false information or documents with this application may be tampering with a governmental record, which is punishable under the Texas Penal Code, Section 37.10

Joseph Strunz

MDFX Owner

Print name

Title

Signature

Date

► **Important:**

Depending on the type of business, applications must be signed by:

- An officer of a corporation.
- The sole proprietor.
- Each partner of a general partnership.
- The general partner of a limited liability partnership.
- An officer or member of a limited liability company.

Applications submitted by a governmental entity must be signed by the appropriate officer. For example, a city’s application should be signed by the mayor, city manager, city administrator, city secretary, etc.

If a partnership, complete the section below.

Print name	Title
------------	-------

Signature	Date
-----------	------

Print name	Title
------------	-------

Signature	Date
-----------	------

4. Payment

Pay by check or money order payable to the Texas Department of Insurance. Mail your completed application, additional documents, and payment to:

Mailing address

State Fire Marshal’s Office
P.O. Box 12107
Austin, Texas 78711-2107

Street address

State Fire Marshal’s Office
333 Guadalupe St.
Austin, Texas 78701

Your rights: You can request information we have about you by emailing OpenRecords@tdi.texas.gov or writing to: Public Information Coordinator, Texas Department of Insurance, PO Box 12030 (mail code GC-ORO) Austin, Texas 78711-2030. You also have the right to ask that we fix information we have about you that is wrong. To ask for a correction, send (1) your name, mailing address, and your phone number, (2) details about what needs to be fixed, and (3) the reason or proof showing why the information is wrong. Send this by email to

RecordCorrections@tdi.texas.gov or by mail to: Record Correction Request, Texas Department of Insurance, PO Box 12030 (mail code CO-AAL-CC), Austin, Texas 78711-2030. There is a different process to change or update information you submitted to the State Fire Marshal's Office (SFMO). To update information submitted to SFMO, email FMLicensing@tdi.texas.gov. There may be a fee to update information held by SFMO.

Singular or Multiple Display Permit Site Diagram/Plan (required)

The site diagram must include all the following elements:

- Address of display location.
- Location of the firing site.
- Location of the spectators.
- Minimum secured area on all sides of the firing site.
- Method of restraint/security on all sides of the firing site.
- Location of health care, detention, and correctional facilities. If there are no such facilities within the distance required by [NFPA 1123](#), 1995 edition, state so on the diagram.
- Location of school buildings and churches. If there are no buildings within 600 feet of the firing site, state so on the diagram.
- Location of any hazardous materials in the area. If there are no hazardous materials within the distance required by [NFPA 1123](#), 1995 edition, state so on the diagram.

Texas State Fire Marshal's Office Site Inspection Certification (required)

1. Permit holder information

Permit holder name Joseph Strunz
Address 593 CR 4808
City Copperas Cove State TX ZIP 76522 County Lampasas
Phone (required) 254-289-4791

2. Display information

Date of display Sat, 1 July 2022 Time 9:30 PM
Date of alternate display Sun, 2 July 2022 Time 9:30 PM

3. Location of display and/or alternate display. If no exact location, please describe the location.

City of Killeen "Community Center Park" 2201 E Veterans Memorial Blvd, Killeen, TX 76543

4. As the fire prevention officer, I approve of the display site and have reviewed the site diagram. Yes No
5. I approve of the location and manner for storage of display fireworks before and during the display. Yes No
6. I approve of the potential landing area for fireworks debris. Yes No
7. The display is to be conducted in compliance with the Texas Occupations Code, Regulation of Fireworks and Fireworks Display, and the Fireworks Rules. Yes No
8. My approval is subject to the following conditions. List conditions, if applicable, or indicate "None."
Final setup joint walk-through safety inspection before sunset (darkness).

9. As the fire prevention officer, I have inspected the display site(s) to determine whether this proposed display is of a nature or in a location that could be hazardous to property or dangerous to any person. This form is my notice to the Texas State Fire Marshal of the results of the inspection as required by the Texas Occupations Code, Section 2154.206.

Fire prevention officer:

Print name James Kubinski Title Fire Marshal
Signature _____ Date _____
Department Fire Department, City of Killeen TX Email jkubinski@killeentexas.gov
Phone 254-501-7671 Cell 254-501-7671

Additional documents

If you are a Texas or foreign corporation submit the following:	If you are a Sole proprietorship or general partnership submit the following:	If you are a Texas or foreign limited partnership submit the following:	If you are a Texas or foreign limited liability company submit the following:
Certificate of General Liability Insurance (SF239)	Certificate of General Liability Insurance (SF239)	Certificate of General Liability Insurance (SF239)	Certificate of General Liability Insurance (SF239)
Corporate charter, Certificate of Existence, or Certificate of Authority issued by the Texas Secretary of State	N/A	Certificate of Limited Partnership, Registration Application for Foreign Limited Partnership issued by the Texas Secretary of State	Certificate of Organization, or Certificate of Authority issued by the Texas Secretary of State
Franchise tax account status must be active with the Texas Comptroller of Public Accounts	N/A	Franchise tax account status must be active with the Texas Comptroller of Public Accounts	Franchise tax account status must be active with the Texas Comptroller of Public Accounts
Assumed Name Certificate from the Texas Secretary of State (if using a DBA)	Assumed Name Certificate from your County clerk (if using a DBA)	Assumed Name Certificate from the Texas Secretary of State (if using a DBA)	Assumed Name Certificate from the Texas Secretary of State (if using a DBA)

*Per Chapter 2154 of the Texas Occupations Code and Section 34.800 of the Texas Administrative Code, Title 28, the Fireworks Rules.

Resources:

- Texas Comptroller 800-252-1386 | comptroller.texas.gov
- Texas Secretary of State www.sos.state.tx.us



U.S. Department
of Transportation

Central Service Center
Operations Support Group

10101 Hillwood Pkwy
Fort Worth, TX 76177

FIREWORKS DISPLAY NOTIFICATION

Company Name: Magic Display Pyrotechnics FX

Email Address of Person Submitting Notification: joe@magicdisplayfireworks.com

Event Name: City of Killeen Texas 4th of July Celebration

On-site Contact: Mr. Joseph Strunz, Magic Display FX

Display Date: Saturday, 01 JUL 2023 **Rain Date:** Sunday, 02 JUL 2023

Display Start Time: 9:30 PM

Duration of Fireworks Display: 30mins

Max Height of Fireworks: 1,000' feet

Address City and State: Community Center Park, City of Killeen, Texas
 2201 E Veterans Memorial Blvd, Killeen, TX 76543

Latitude: 31.11062 N **(North)** **Longitude:** -97.70933 W **(West)**

List the closest public use airport within 5 Nautical Miles of the display if the fireworks will reach or exceed 500 ft. _____

#1. Killeen Skylark Airfield private airport (2 mi),

#2. Fort Hood Army Airfield (1.3 mi)

#3. Killeen-Fort Hood Regional Airport, Robert Gray (7.3 mi)

Special Notes: Commercial Pyrotechnics Public Display.

Email to: 9-ASW-Operations-Support-Fireworks@faa.gov

Fireworks Display: FAA NOTAM Demographics
Time: 9:30PM Date: Sat, 01 July 2023
Location: City of Killeen, Texas

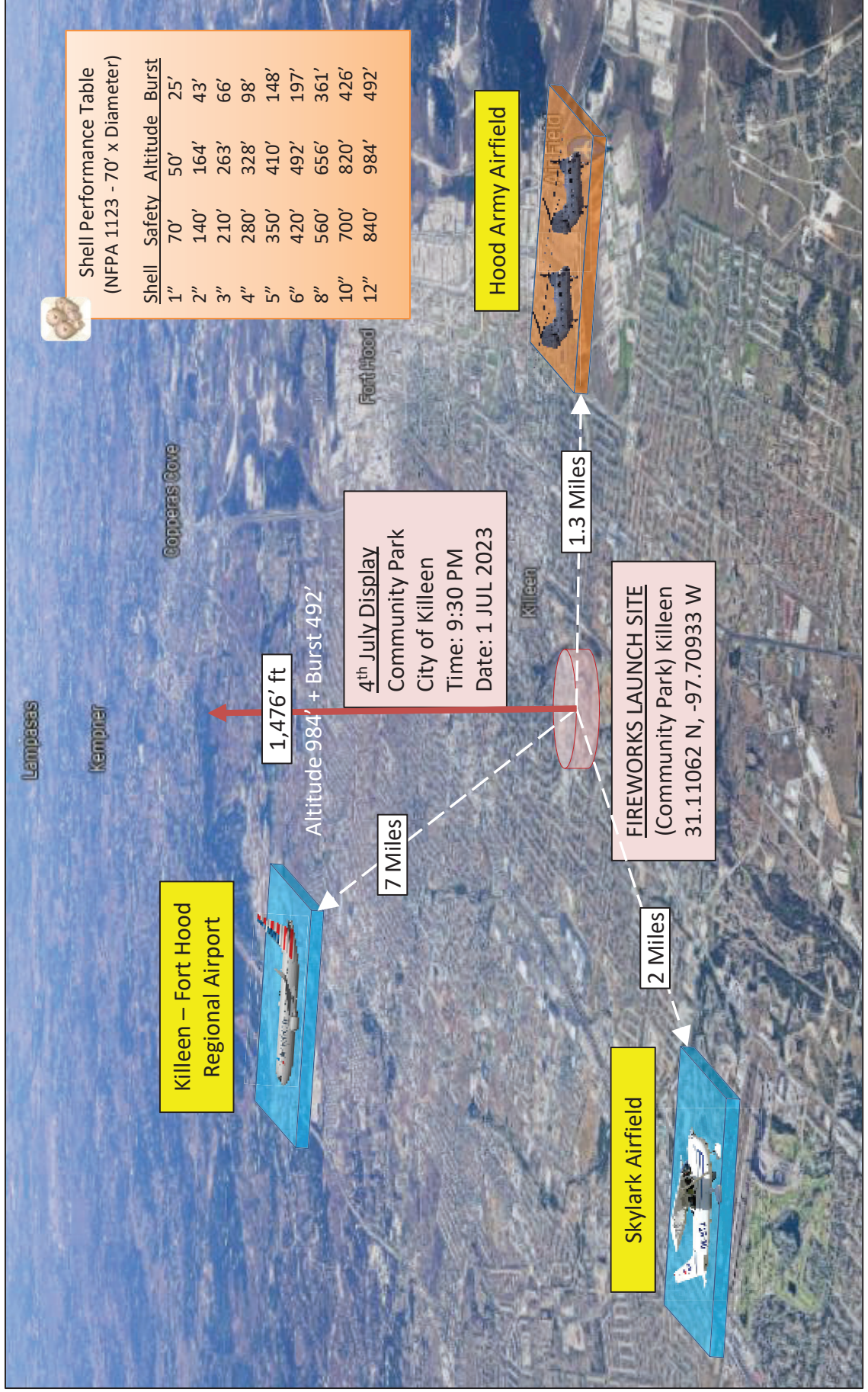



HEALTH, SAFETY AND ENVIRONMENT STATEMENT

MDFX (Magic Display FX) is a small all veteran company with service members that have experience when it comes to safety, health and environment. Solving customer challenges is second only to keeping everyone safe and healthy. We won't compromise our focus on health, safety and environment for better business results. Our commitment to safety will minimize the impact on the environment, control risks to our employees, and maintain safe work practices. Our dedication will match our commitment so that each MDFX employee takes personal ownership of their own safety and the safety of others.

Turning our commitments into practice is at the heart of our journey to ZERO. Simply stated, it's a concerted effort to achieve ZERO health, safety and environmental incidents every day, all the time. Our ZERO goal is to make it happen around the clock, everywhere.

MDFX will continue to keep its strategic focus on these key Health, Safety and Environment areas:

- Effective leadership and commitment
- Continuous improvement of our MDFX Management System
- Training and competency of our employee workforce
- Providing mechanisms for employees to communicate and address risk
- Continuous improvement of technology and processes to mitigate HSE impact
- Verification of performance through robust audits and communication of key findings



CERTIFICATIONS & LICENSES

MDFX (Magic Display FX) is federal and state trained, certified, licensed and insured in commercial explosives and flame production categories. MDFX has memberships with leading industries qualified to perform indoor, outdoor, land and water displays, special effects and flame productions.



Texas State Certifications & Licenses							
	Permit Type	Pyrotechnic Type			Operations		
		Fireworks 1.3G	Fireworks 1.4G, 1.4S	Flame Effects	Assembles Displays	Conducts Displays	Supervises Displays
	FPO - Pyrotechnics	✓	✓	✓	✓	✓	✓
	SEO - Special Effects	✓✓	✓✓	✓✓	✓	✓	✓
	FEO - Flame Effects	✓	✓	✓	✓	✓	✓

✓✓ Using Fireworks 1.3G or Fireworks 1.4G where audiences are closer to pyrotechnic devices than permitted by NFPA 1123 Code of Fireworks Display.

Federal Certifications & Licenses			
	Permit Type	U.S. DOJ BATFE Federal Explosives License (FEL)	U.S. DOJ BATFE Federal Security Clearance (FSC)
	Explosives	✓	✓

Professional Specialty Insurance				
	Displays	Pyrotechnics	Flames	Special Effects
	✓	✓	✓	✓



Public Displays – Theme Parks, Concerts, Stadiums, Festivals, Special Events



Special Effects – Production, Stage Performance & Close Proximity Audiences
(Indoor/Outdoor Concerts, Theaters, Television Studios, Motion Picture)



Flame Effects – Production, Stage Performance & Close Proximity Audiences
(Indoor/Outdoor Concerts, Theaters, Television Studios, Motion Picture)

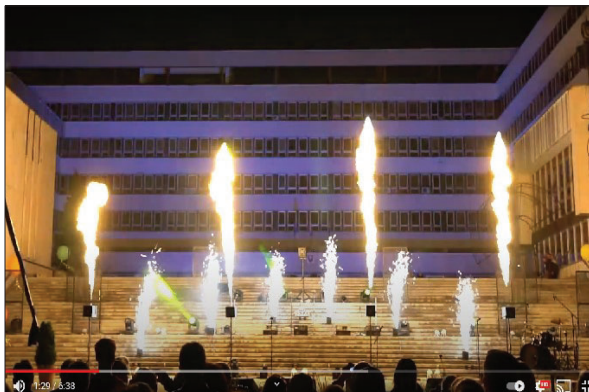



<p>Issued To: Strunz, Joseph Andrew 593 COUNTY ROAD 4808 COPPERAS COVE TX 76522-6300</p>	<p>License Number FPO-2006642 Expiration Date: 06-03-2023 EFFECTIVE DATE: 06-03-2015</p>
<p>FIREWORKS PYROTECHNIC OPERATOR'S LICENSE TEXAS DEPARTMENT OF INSURANCE STATE FIRE MARSHAL'S OFFICE</p>	
<p>DATE ISSUED: March 7, 2022</p>	 Orlando P. Hernandez, State Fire Marshal
<p>SF081 1119</p>	
<p>Issued To: Strunz, Joseph Andrew 593 COUNTY ROAD 4808 COPPERAS COVE TX 76522-6300</p>	<p>License Number SEO-2661479 Expiration Date: 04-26-2023 EFFECTIVE DATE: 04-26-2021</p>
<p>FIREWORKS SPECIAL EFFECTS OPERATOR'S LICENSE TEXAS DEPARTMENT OF INSURANCE STATE FIRE MARSHAL'S OFFICE</p>	
<p>DATE ISSUED: February 11, 2022</p>	 Orlando P. Hernandez, State Fire Marshal
<p>SF081 1119</p>	
<p>Issued To: Strunz, Joseph Andrew 593 COUNTY ROAD 4808 COPPERAS COVE TX 76522-6300</p>	<p>License Number FEO-2661474 Expiration Date: 04-26-2023 EFFECTIVE DATE: 04-26-2021</p>
<p>FIREWORKS FLAME EFFECTS OPERATOR'S LICENSE TEXAS DEPARTMENT OF INSURANCE STATE FIRE MARSHAL'S OFFICE</p>	
<p>DATE ISSUED: February 11, 2022</p>	 Orlando P. Hernandez, State Fire Marshal
<p>SF081 1119</p>	



U.S. Department of Justice
Bureau of Alcohol, Tobacco, Firearms and Explosives
Federal Explosives Licensing Center
244 Needy Road
Martinsburg, West Virginia 25405

901090: CRR/FLS
5400
File Number: **5TX01779**

06/04/2020

SUBJECT: **RESPONSIBLE PERSON LETTER OF CLEARANCE for:**

JOSEPH ANDREW STRUNZ

OWNER USER
(254)289-4791

593 CR 4808
COPPERAS COVE, TX 76522

and is ONLY valid under the following Federal explosives license/permit:

5-TX-099-54-3H-01779

STRUNZ, JOSEPH
593 COUNTY ROAD 4808
COPPERAS COVE, TX 76522

Dear JOSEPH STRUNZ:

You have been approved as a responsible person under the above-listed Federal explosive license or permit. You may lawfully direct the management or policies of the business or operations as they pertain to explosives. You may also lawfully transport, ship, receive or possess explosive materials incident to your duties as a responsible person. **This clearance is only valid under the license or permit referenced above.**

Sincerely,

Christopher R. Reeves
Chief, Federal Explosives Licensing Center (FELC)

FELC Customer Service. If you believe that information on your "Letter of Clearance" is incorrect, please return a COPY of the letter to the Chief, Federal Explosives Licensing Center (FELC), with a statement showing the nature of the error. The Chief, FELC, shall correct the error, and return an amended letter to you.

Mail: ATF
Chief, FELC
Attn.: LOC Correction
244 Needy Road
Martinsburg, West Virginia 25405

Fax: 1-304-616-4401
Chief, FELC
Attn.: LOC Correction

Call toll-free: 1-877-283-3352

WWW.ATF.GOV

JOSEPH ANDREW STRUNZ

Responsible Person Letter of Clearance for:

5TX01779-R-06/04/2020-STRUNZ,JOSEPH-ANDREW-OWNER USER



U.S. Department of Justice Bureau of Alcohol, Tobacco, Firearms and Explosives		Federal Explosives License/Permit <i>(18 U.S.C. Chapter 40)</i>	
In accordance with the provisions of Title XI, Organized Crime Control Act of 1970, and the regulations issued thereunder (27 CFR Part 555), you may engage in the activity specified in this license or permit within the limitations of Chapter 40, Title 18, United States Code and the regulations issued thereunder, until the expiration date shown. THIS LICENSE IS NOT TRANSFERABLE UNDER 27 CFR 555.53. See "WARNINGS" and "NOTICES" on reverse.			
Direct ATF Correspondence To	ATF - Chief, FELC 244 Needy Road Martinsburg, WV 25405-9431	License/Permit Number	5-TX-099-54-3H-01779
Chief, Federal Explosives Licensing Center (FELC)	<i>Christopher R. Keers</i>	Expiration Date	August 1, 2023
Name STRUNZ, JOSEPH			
Premises Address (Changes? Notify the FELC at least 10 days before the move.) 593 COUNTY ROAD 4808 COPPERAS COVE, TX 76522-			
Type of License or Permit 54-USER OF EXPLOSIVES			
Purchasing Certification Statement <small>The licensee or permittee named above shall use a copy of this license or permit to assist a transferor of explosives to verify the identity and the licensed status of the licensee or permittee as provided by 27 CFR Part 555. The signature on each copy must be an original signature. A faxed, scanned or e-mailed copy of the license or permit with a signature intended to be an original signature is acceptable. The signature must be that of the Federal Explosives Licensee (FEL) or a responsible person of the FEL. I certify that this is a true copy of a license or permit issued to the licensee or permittee named above to engage in the business or operations specified above under "Type of License or Permit."</small>		Mailing Address (Changes? Notify the FELC of any changes.) STRUNZ, JOSEPH 593 COUNTY ROAD 4808 COPPERAS COVE, TX 76522-	
<i>Joseph A Strunz</i> Licensee/Permittee Responsible Person Signature	OWNER Position Title		
<i>Joseph A Strunz</i> Printed Name	<i>11 June 2020</i> Date		
Previous Edition is Obsolete STRUNZ, JOSEPH 593 COUNTY ROAD 4808 76522-9 TX 099-54-3H-01779 August 1, 2023 54-USER OF EXPLOSIVES ATF Form 5400.14/5400.15 Part I Revised October 2011			
Federal Explosives License (FEL) Customer Service Information			
Federal Explosives Licensing Center (FELC) 244 Needy Road Martinsburg, WV 25405-9431	Toll-free Telephone Number: (877) 283-3352 Fax Number: (304) 616-4401 E-mail: FELC@atf.gov	ATF Homepage: www.atf.gov	
Change of Address (27 CFR 555.54(a)(1)). Licensees or permittees may during the term of their current license or permit remove their business or operations to a new location at which they intend regularly to carry on such business or operations. The licensee or permittee is required to give notification of the new location of the business or operations not less than 10 days prior to such removal with the Chief, Federal Explosives Licensing Center. The license or permit will be valid for the remainder of the term of the original license or permit. (The Chief, FELC, shall, if the licensee or permittee is not qualified, refer the request for amended license or permit to the Director of Industry Operations for denial in accordance with § 555.54.)			
Right of Succession (27 CFR 555.59). (a) Certain persons other than the licensee or permittee may secure the right to carry on the same explosive materials business or operations at the same address shown on, and for the remainder of the term of, a current license or permit. Such persons are: (1) The surviving spouse or child, or executor, administrator, or other legal representative of a deceased licensee or permittee; and (2) A receiver or trustee in bankruptcy, or an assignee for benefit of creditors. (b) In order to secure the right provided by this section, the person or persons continuing the business or operations shall furnish the license or permit for that business or operations for endorsement of such succession to the Chief, FELC, within 30 days from the date on which the successor begins to carry on the business or operations.			
(Continued on reverse side)			
<p>Cut Here ✂</p> <p style="text-align: center;">Federal Explosives License/Permit (FEL) Information Card</p> <p>License/Permit Name: STRUNZ, JOSEPH</p> <p>Business Name: MAGIC DISPLAY FX</p> <p>License/Permit Number: 5-TX-099-54-3H-01779</p> <p>License/Permit Type: 54-USER OF EXPLOSIVES</p> <p>Expiration: August 1, 2023 <i>JK</i></p> <p>Please Note: Not Valid for the Sale or Other Disposition of Explosives.</p>			



U.S. Department of Justice
Bureau of Alcohol, Tobacco, Firearms and Explosives
Federal Explosives Licensing Center (FELC)
www.atf.gov

Federal Explosives Licensing Center
244 Needy Road
Martinsburg, West Virginia 25405
telephone: (877)283-3352 fax: (304)616-4401

NOTICE OF CLEARANCE

for individuals transporting, shipping, receiving, or possessing explosive materials.

ISSUED TO: STRUNZ, JOSEPH
NOTICE DATE: 06/04/2020

Federal Explosives license/permit no.: 5-TX-099-54-3H-01779
Expiration Date: **August 1, 2023**
Explosives License/Permit Type: 54-USER OF EXPLOSIVES

EXPIRATION DATE: This Notice expires when superseded by a newer Notice which will list all current responsible persons and employee possessors, or when the license or permit expires - whichever comes first.

- 1 **WARNING.** Only those individuals listed below as RESPONSIBLE PERSONS and EMPLOYEE POSSESSORS with a background clearance status of "CLEARED" or "PENDING" are authorized to transport, ship, receive, or possess explosive materials in the course of employment with you.
- 2 **"DENIED" STATUS.** If an employee possessor has a background clearance status of "DENIED", you MUST take immediate steps to remove the employee from a position requiring the transporting, shipping, receiving, or possessing of explosive materials. Also, if the employee has been listed as a person authorized to accept delivery of explosive materials, you MUST remove the employee from such list and immediately, and in no event later than the second business day after such change, notify distributors of such change, as stated in 27 CFR 555.33(a).
- 3 **CHANGE IN RESPONSIBLE PERSONS.** You MUST report any change in responsible persons to the Chief, Federal Explosives Licensing Center, within 30 days of the change and new responsible persons MUST include "appropriate identifying information" as defined in 27 CFR 555.11. Fingerprints and photos are NOT required, however they will be required upon renewal of the license or permit.
- 4 **CHANGE OF EMPLOYEES.** You MUST report any change of employee/possessors to the Chief, FELC, within 30 days. Reports relating to newly hired employees must be submitted on ATF Form 5400.28 for EACH employee.

Premises Address: 593 COUNTY ROAD 4808
COPPERAS COVE, TX 76522

Mailing Address:
STRUNZ, JOSEPH
593 COUNTY ROAD 4808
COPPERAS COVE, TX 76522

This 'Notice of Clearance' is provided to you as required by 18 U.S.C. 843(h) and MUST be retained as part of your permanent records and be made available for examination or inspection by ATF officers as required by 27 CFR 555.121. If you receive a Notice subsequent to this Notice, this Notice will no longer be valid.

In accordance with 27 CFR 555.33, Background Checks and Clearances, and 27 CFR 555.57, Change of Control, Change in Responsible Persons, and Change of Employees, ATF's Federal Explosives Licensing Center (FELC) has conducted background checks on the individual(s) you identified as a responsible person(s) and an employee/possessor(s) on your application, or reported after the issuance of your license/permit.

The following is a SUMMARY of the results of the background checks conducted on the individuals you reported as responsible persons and employee/possessors. ATF will be notifying ALL individuals listed on this document of their respective status by separate letter mailed to their residence address.

PLEASE BE ADVISED THAT IT IS UNLAWFUL FOR ANY PERSON REFLECTING A STATUS OF "DENIED" TO TRANSPORT, SHIP, RECEIVE, OR POSSESS EXPLOSIVE MATERIALS.

Please carefully review this Notice to ensure that all the information is accurate. If this Notice is incorrect, please return the Notice to the Chief, FELC, with a statement showing the nature of the error(s). The Chief, FELC, shall correct the error, and return a corrected Notice.

Number of RESPONSIBLE PERSON(S) : 1
Number of EMPLOYEE POSSESSOR(S): 0

LAST NAME, First Name, Middle Name	Clearance Status
RESPONSIBLE PERSONS:	1
0001 STRUNZ, JOSEPH ANDREW	Cleared
EMPLOYEE POSSESSORS:	0

continued

LAST NAME, First Name, Middle Name Clearance Status

5-TX-099-54-3H-01779; expiration date: August 1, 2023; STRUNZ, JOSEPH; 593 COUNTY ROAD 4808; COPPERAS COVE, TX 76522



SEVERE WEATHER OPERATIONAL PROCEDURES

(Severe weather includes blizzards, thunderstorms, high winds, large hail or tornados)

MDFX (Magic Display FX) will maintain operational control of all display sites during severe weather through the following procedures. These procedures are compatible with Magic Display BATFE (Bureau of Alcohol, Tobacco, Fire Arms and Explosives) and DHS (Department of Homeland Security) Hazardous Materials Security Plan and are designed to prevent unauthorized access to 1.3G and 1.4G explosives materials.

Severe Wind Conditions (Tornado Category F1+; Hurricane C1+)

Reference NFPA 2010 8.1.4.2; 8.1.7

- When there is emanate threat of severe wind conditions, operator will as practical, secure all firing equipment and remove all explosive material from the site for storage in an BATFE approved Type IV magazine.
- If energetic material has been loaded for firing, operator will:
 - If safely possible, remove all explosive material from the site for storage in an approved Type IV magazine
 - If time does not allow for safe removal, operator will coordinate with the AHJ to fire all product before the onset of severe winds to prevent explosive materials from being uncontrollable blown from the display site.

Rain Conditions

- Operator will ensure that loading continues in a safe manner (Reference NFPA 2010 8.1.7)
 - Product shall not be loaded into wet mortars
 - All product shall be weather wrapped as loaded
 - Proximate devices including one shot comets, gerbs, fountains, SPD's and other effects that by their design, are not able to be wrapped shall not be loaded.
 - Crew shall work in teams with one member loading devices while the other member covers and protects from rain.

Electrical Events

- When lightning is detected within 7 miles of the display site all loading shall halt until conditions improve
 - Operator shall disconnect the firing system from all electrical connections
 - All Modules shall be turned off and antenna receivers folded down
 - All electrical matches shall be stored in wooden case/ready box at least 50 feet from all explosive materials
 - Operator shall keep crew at least 50 feet from all loaded explosives and maintain NFPA spectator distances of at least 70 feet per inch until the material is:
 - Safely removed from the site for storage in an approved Type IV magazine
 - Fired in coordination with the AHJ
 - In the event of uncontrolled electrical ignition
 - Operator will maintain operational control of site
 - Increase the safety distances as warranted
 - Immediately notify MDFX Director of Operations for implementation of **Occurrence Mitigation Plan**

Extreme Temperature

- When temperatures exceed 110° F or are below 28° F loading of the show will be discontinued until conditions return to safe loading temperature range.

High Wind Speeds During Show (15+ MPH Sustained) Reference NFPA 2010 A.8.1.4.2

- In considering when wind speed is excessive for the reasonably safe performance of a fireworks display, operator will judge:
 - The potential for an increased risk of hazardous debris from the display falling into the spectator areas
 - The potential for an increased probability of fire that is made excessively difficult to control
- An increased fallout hazard occurs when the wind is traveling in a direction toward one or more spectator areas. Under these circumstances mitigation strategies that should be considered are as follows:
 - To move the spectators out of the path of the fallout
 - To redirect the fallout by moving the fireworks or re-angling the mortars
 - To increase the separation distance between the fireworks and the spectators
 - To modify the content of the display to eliminate the fireworks of greatest concern
 - To delay the display until the weather conditions have improved

- To implement a combination of these strategies
- Some possible mitigation strategies to be considered regarding fire risks are as follows:
 - To water down the areas and items of concern immediately before the display
 - To redirect the fallout by moving the fireworks or re-angling the mortars
 - To increase the separation distance between the fireworks and the areas containing the fire hazards
 - To modify the content of the display to eliminate the fireworks of greatest concern
 - To increase the amount of suppression equipment and personnel in the immediate area
 - To delay the display until weather conditions have improved
 - Show will be discontinued or cancelled if winds exceed 20 MPH sustained or during gusts above 25 MPH
 - NFPA safety distance will assume to be double at 20 MPH causing the operator to cut the permissible shell diameter in half until winds stabilize below 20 MPH

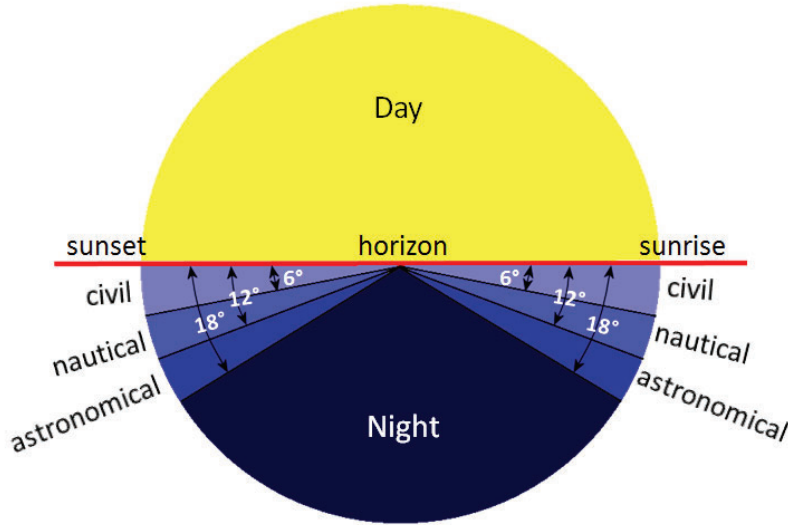

DISPLAY TIME ZONE TABLE

EARLIEST TIME: for public displays is at the end of *Nautical Twilight* and start of *Astronomical Twilight* usually 9:15 or 9:20 PM during Spring/Summer months.

BEST TIME: for maximum visual effects, best time to start display is the “sweet spot”, which is end of *Astronomical Twilight* and start of *Night*, usually 9:30 PM.

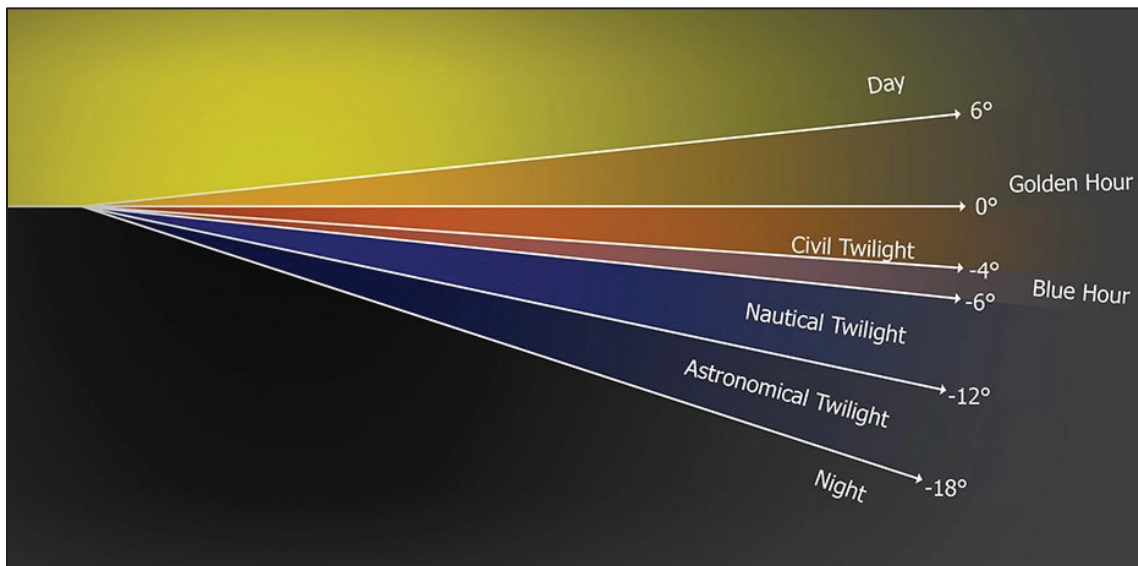



TYPICAL 1.3G AERIAL SHELL PERFORMANCE TABLE



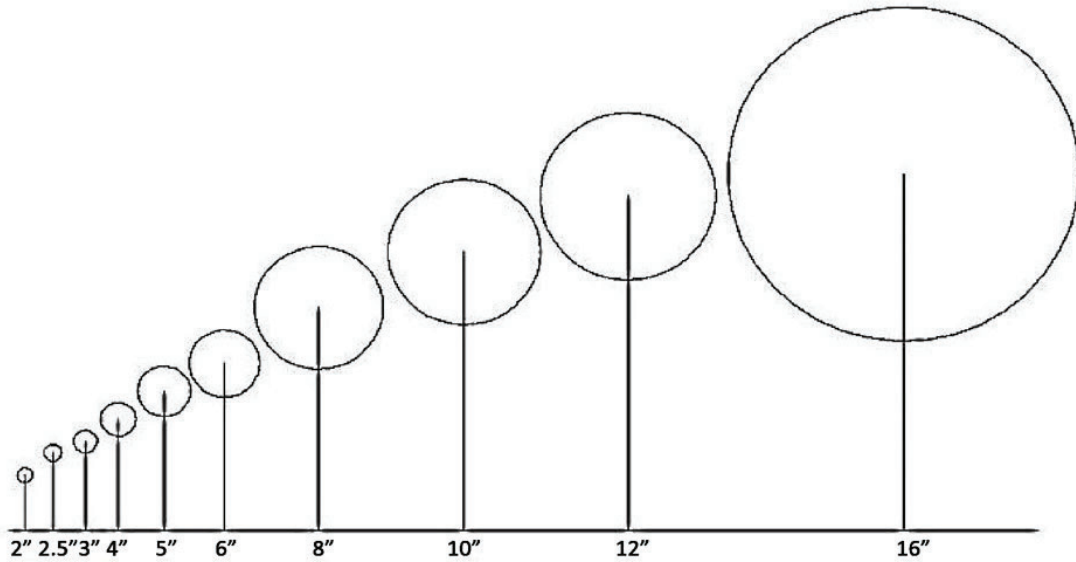





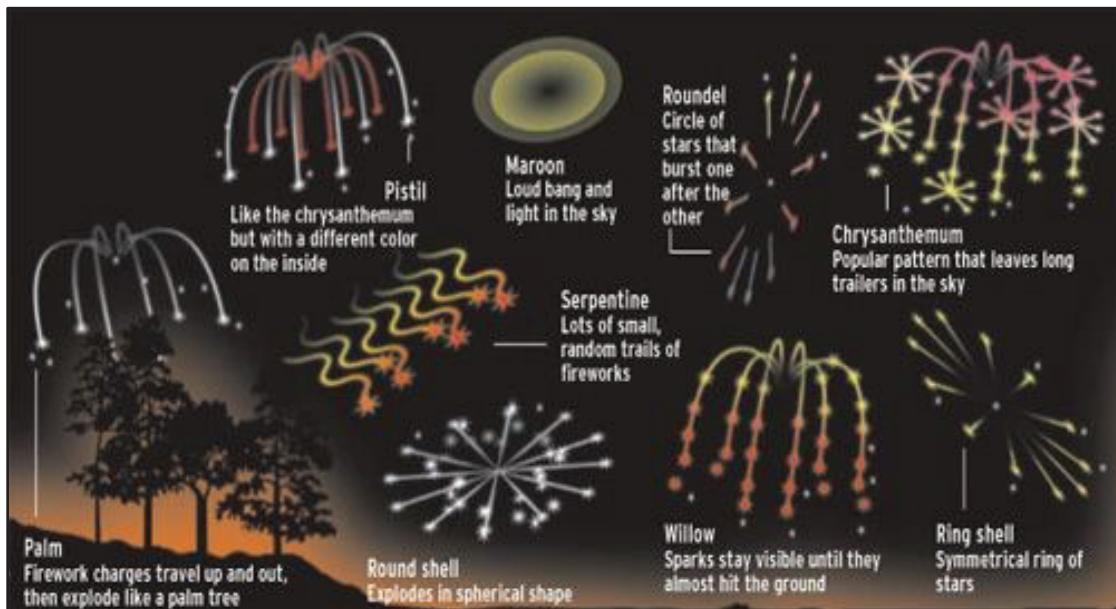

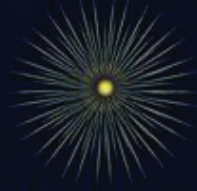



BURST DIAMETER	43' 49' 66' 98' 148' 197'	361'	426'	492'	984'
RISING HEIGHT	164' 230' 263' 328' 410' 492'	656'	820'	984'	1,050'

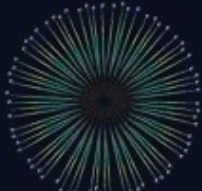



SHELL & SPECIALTY EFFECTS GUIDE



<p>Brocade</p>  <p>Common term that describes an effect of woven gold clusters usually bound together within a star burst.</p>	<p>Chrysanthemum</p>  <p>A perfectly spherical burst of tailed stars, very much like the flower it represents.</p>	<p>Comet</p>  <p>A star or other projectile which leaves a glittering, persistent trail behind it.</p>	<p>Crossette</p>  <p>A set of stars that each split into four or five stars and leave a trail as they map the skies.</p>
<p>Green Bees</p>  <p>A swarm or cluster of points of light that move and dissipate under their own power. Similar to Fish but less vigorous and generally less persistent.</p>	<p>Glitter</p>  <p>A constant spray of strobing glitter effect usually referring to cones and fountains</p>	<p>Palm</p>  <p>Bright arms of cascading, long lasting stars, shaped to permeate outward like the branches of a palm tree, usually made up of gold or silver stars.</p>	<p>Pearls</p>  <p>A set of bright glowing stars that do not leave a trail but silently rise and dissolve into the heavens.</p>
<p>Peony</p>  <p>Well used term to describe a perfect expanding sphere to stars that usually change colour as they burst outwards.</p>	<p>Pistil</p>  <p>A central effect sometimes palm like that can be added to a Peony or Chrysanthemum for bigger impact.</p>	<p>Silver Fish</p>  <p>Invariably silver and preceded by a beautiful blue tracer star, they wriggle and swim away from the centre in a silently mesmerizing dance.</p>	<p>Spinner</p>  <p>An aerial effect that is usually accompanied by a whirling sound as the stars spin and whirl individually and synchronised to others.</p>
<p>Stars</p>  <p>A glowing, flaming ball of coloured light or colourless crackle that can rise on their own or burst into variegated mini star-shells.</p>	<p>Strobe</p>  <p>An effect that flickers and flashes in the sky like a gallery of flash bulbs.</p>	<p>Tail</p>  <p>The comet like trail that is left behind the star.</p>	<p>Willow or Falling Leaves</p>  <p>A star burst where all the stars "fall" out of the rocket or star-shell and gently drift down to earth to give a delightful effect, best in gold.</p>

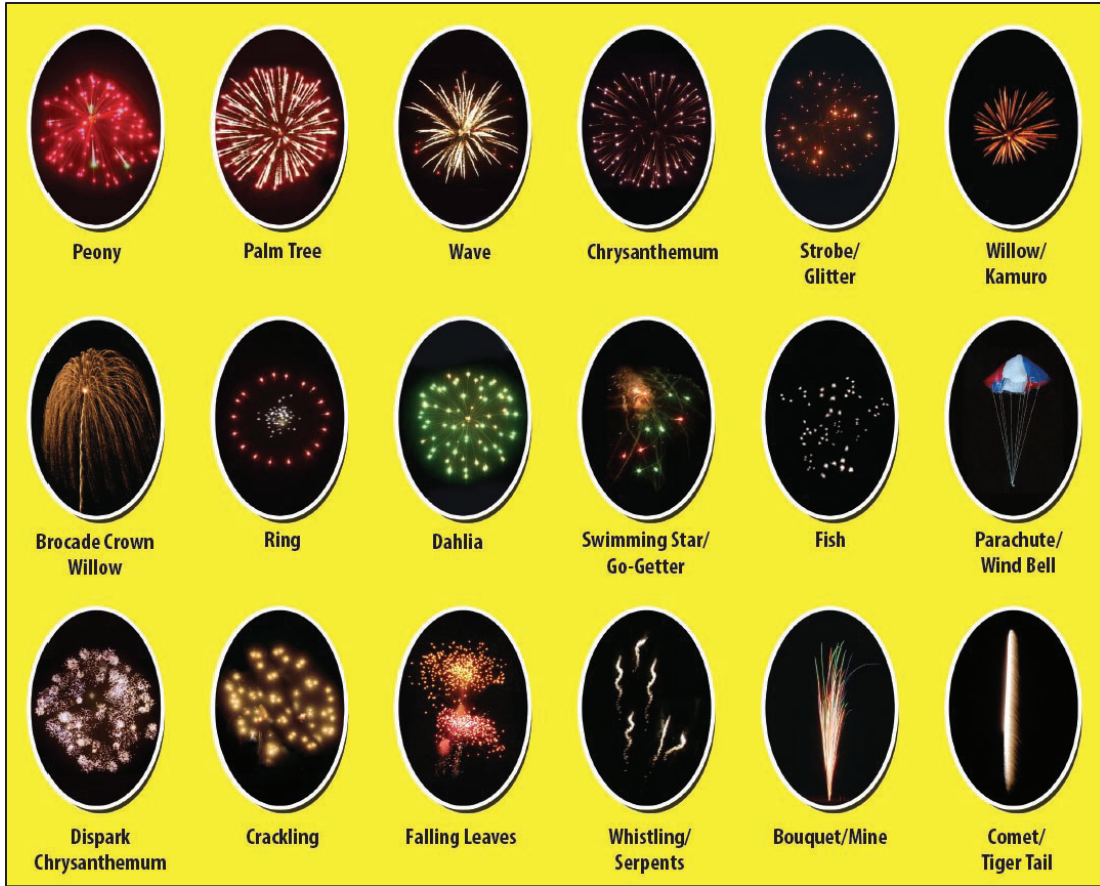

Theme Park Style Display

City of Killteen 4th of July Spectacular

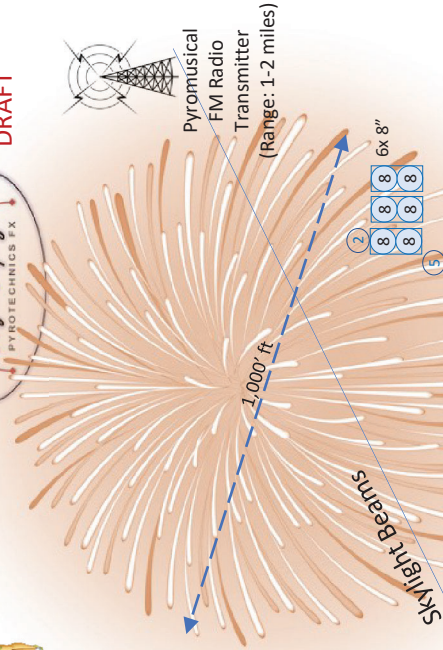
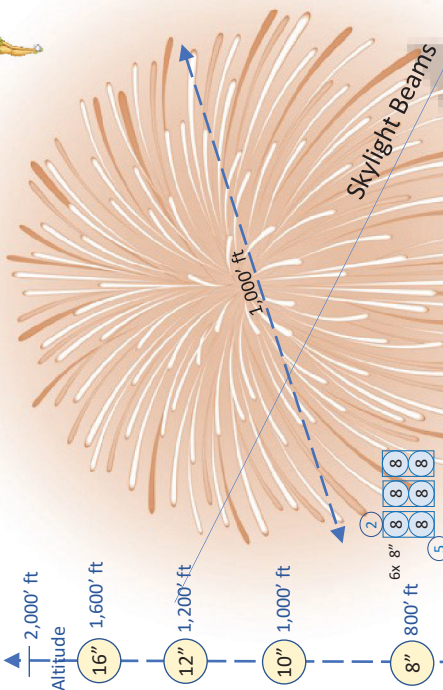

Update
11 January 2023
DRAFT

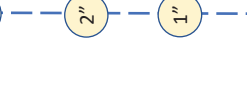
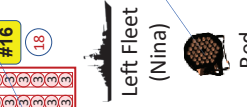
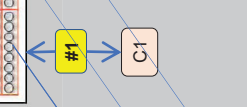
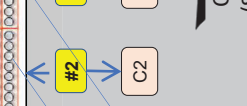
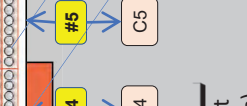
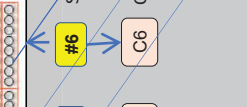
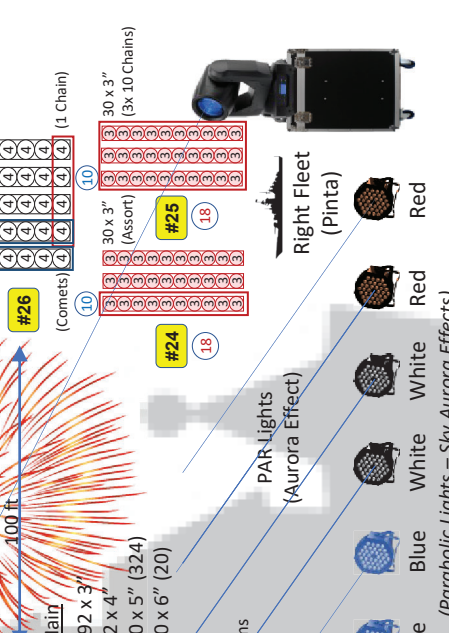
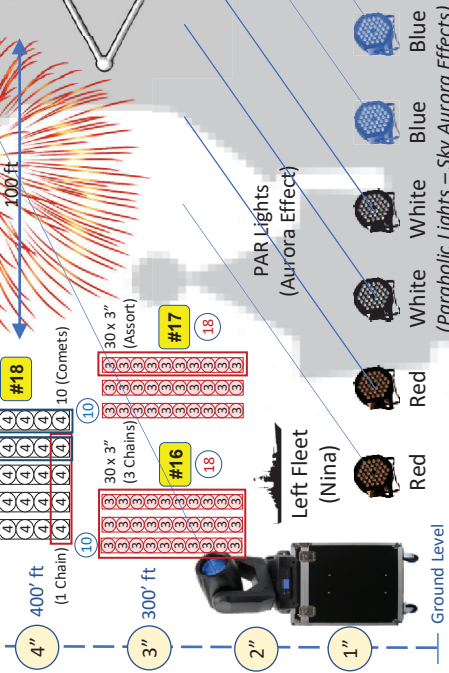
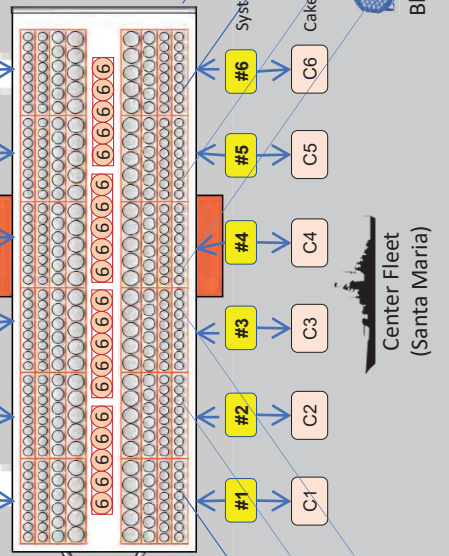
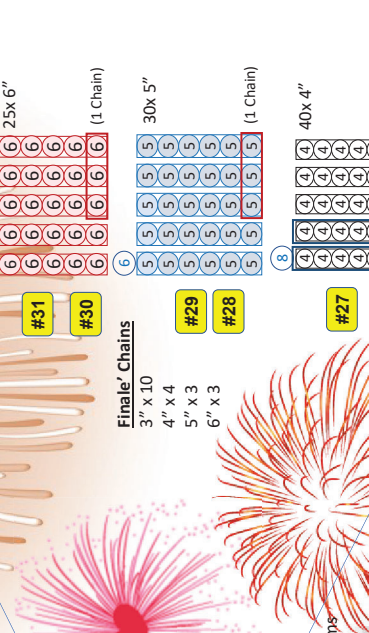
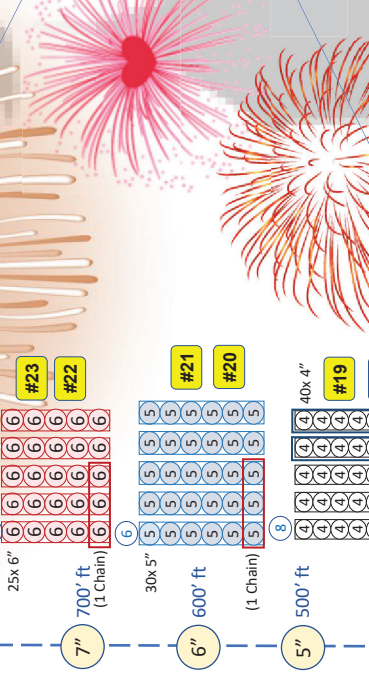
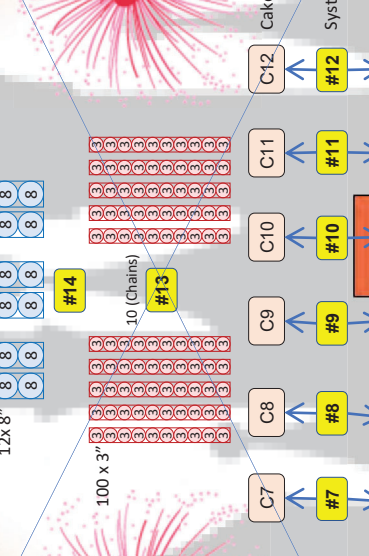
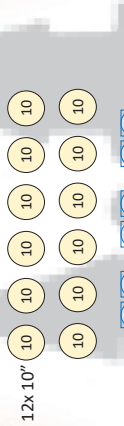
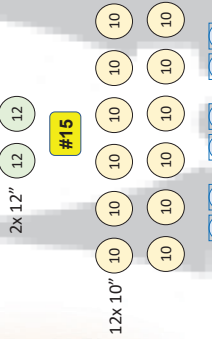
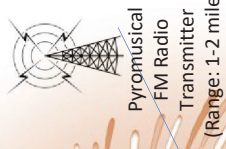

Ground Level
1,000' ft (Above Sea Level)

PAR Lights
(Aurora Effect)

Center Fleet
(Santa Maria)

PAR Lights
(Aurora Effect)

Right Fleet
(Pinta)

Pyromusical
FM Radio
Transmitter
(Range: 1-2 miles)

Skylight Beams

Skylight Beams

Skylight Beams

Skylight Beams

Skylight Beams

Skylight Beams

Skylight Beams

Skylight Beams

Skylight Beams

Skylight Beams

Skylight Beams

Skylight Beams

Skylight Beams

Skylight Beams

Skylight Beams

Skylight Beams

Skylight Beams

Engineered by: *MDFX*



ANNEX Z: Site Survey Plan

4th July Pyrotechnics Display

Community Center Park, City of Killeen, Sat, 01 July 2023
Site Survey Plan



Update
9 March 2023

Launch DTG: 9:30 PM, Saturday, 01 JUL 2023



Sunrise: 6:33 AM



Sunset: 8:40 PM

Grid Coordinates: 31.11062 N, -97.70933 W

Authority Having Jurisdiction (AHJ)

Name: James Kubinski

Title: Fire Chief, City of Killeen, TX

Telephone: 254-501-7671

Signature: _____
Approved _____ Disapproved, Date: _____

City Leadership Intent: Majority of spectators are mainly 1.3 miles away downtown Killeen attending the festival. City of Killeen is trying to promote downtown growth for businesses and festivals. That's the reason for larger shells so viewers can spectate display from any location in the city. *Community Park is closed to accomplish leadership strategy.

Expected Wind Direction



Main Spectators 1.3 miles
Zone #1 Downtown



Spectator Zone #2

Spectator Zone #3

IAW NFPA 1123 Regulations

- No health care facility within 600' ft.
- No schools, Churches within 600' ft.
- No hazmat within 800' ft.

Shell Performance Table (NFPA 1123 - 70' x Diameter)

Shell	Safety	Altitude	Burst
1"	70'	50'	25'
2"	140'	164'	43'
3"	210'	263'	66'
4"	280'	328'	98'
5"	350'	410'	148'
6"	420'	492'	197'
8"	560'	656'	361'
10"	700'	820'	426'
12"	840'	984'	492'

Legend

- Road Block
- Display Site
- Pyro (enclosed trailer)
- Fire Department (FD)
- Police Department (PD)

